

LAGOON 380

Owner's Manual



www.cata-lagoon.com

We share a common passion for the sea: we, LAGOON as shipbuilders and you who want to live your passion on the Seven Seas.

We are delighted to welcome you to the great family of LAGOON boat owners and we congratulate you on it.

This manual was meant to help you to enjoy your boat comfortably and safely. It includes the boat specifications, the equipment provided or installed, the systems and tips on her operation and maintenance. Read this manual carefully before you put out to sea so that you can make the most of her and avoid any damage and any trouble. Get to know your boat before you sail.

We keep improving our boats as we want you to benefit from the technological developments, new equipment or materials and our own experience. That is the reason why the specifications and information given are not contractual, they may be modified without prior notice or up dates.

This instruction guide has a general purpose and it may mention some equipment or accessories or deal with some points or questions that are not relevant to your own boat ; if in doubt, refer to the inventory that you received on delivery of your boat.

Our network of LAGOON authorized dealers will be at your disposal to help you get acquainted with your boat and will be the most qualified to take care of her maintenance.

If this is your first boat or if you change to a new type of boat which you are not used to, get some training in boat control and sailing to ensure your safety and comfort. Your dealer, your international sailing association or your yacht club will be very happy to recommend local sailing schools or professional instructors.

Even if everything has been provided for and designed for the safety of the boat and the safety of her users, don't forget that sailing highly depends on the weather conditions, the sea condition, and that only an experienced and very fit crew, handling a well-maintained boat can sail satisfactorily.

The sea and wind conditions that correspond to the design categories A,B or C are changeable and are dependent on the hazards of unusually strong waves or gusty winds. Therefore total safety cannot be guaranteed, even if your boat meets the requirements of a category.

Always listen to the weather forecast before you put out to sea. Make sure the sea and wind conditions will correspond to the category of your boat and you and your crew are able to handle the boat in these conditions.

The sea and the water are not the natural environment of Man and one has to respect their laws and strength.

Adapt the use of your boat to her condition that wears out with time and use.

Any boat, however solid she may be, may be severely damaged if badly used. This is not compatible with a secure navigation. Always adapt the speed and direction of your boat to the conditions of the sea.

The 'COLREG', an international regulation in order to prevent collision at sea, published by the International Maritime Organization, specifies the steering and course regulations, the navigation lights etc. throughout the world. Make sure you know these regulations and you have on board a manual that explains them.

In numerous countries, a licence, an authorization or a training course is requested. Make sure you have this legal authorization before you use your boat.

Always use an experienced technician for the maintenance of your boat, the fitting of accessories and the carrying out of small modifications. The written authorization of the builder or his legal representative is compulsory for modifications that alter the specifications of the boat, in particular the vertical layout of the grounds (putting up of a radar, modification of the mast, change of the engine etc.).

For the essential or optional equipment (engine, electronics etc.) refer to their respective manual delivered with your boat.

The users of the boat are informed of the following:

- The entire crew must be trained properly.
- The boat shall not be loaded more with than the maximum load recommended by the builder, in particular the total weight of the food supplies, of the different equipment that are not supplied by the builder and of the persons on board. The weight of the boat shall be properly distributed.
- The water in the bilge shall be kept at its minimum.
- The stability is reduced when you add weight in the upper parts.
- In case of heavy weather, the hatches, lockers and doors shall be closed in order to minimize the risk of water coming in.
- The stability may be reduced when you tow a boat or when you lift heavy weights with the davits or the boom.
- Breakers are serious dangers to stability.
- In the boat there shall be all the proper safety equipment (harness, flares, liferaft etc.) depending on the type of boat, the country, the weather
- The crew must be familiar with the use of all the safety equipment and the emergency safety procedures (MOB, towing etc.).
- Anyone on the deck shall wear a life jacket or a buoyancy aid. Please note that in some countries it is compulsory to wear an homologated buoyancy aid permanently.

Keep this manual in a safe place and hand it over to the new owner if you sell your boat.

CONTENTS

This user's guide may sometimes list equipment or touch on certain topics which are not part of the standard specifications of your particular boat.
The guide covers all the versions and main options of these models.

Chapter		Page
	<i>Using your boat</i>	
1	Navigation	5
2	Winter Storage	23
3	Launching	27
	<i>Construction and equipment</i>	
4	Hull & Deck	35
5	Interior	41
6	Electricity	49
7	Plumbing	59
8	Engine	69
9	Rigging & Sails	79
10	Safety	93
11	General specifications	105
	Notes	

Navigation

1

GETTING UNDER WAY	7
VISIBILITY IN NAVIGATION	7
NAVIGATION UNDER MOTOR.....	9
NAVIGATION UNDER SAIL	11
MOORING	17
TOWING.....	17
ANCHORING	17
DAVIT (OPTIONAL).....	21
ENVIRONMENT	21

GETTING UNDER WAY



**LOCKING
SLIDING DOOR**

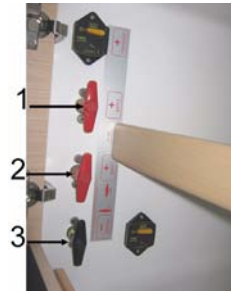

**BATTERY SWITCH
PORT AFT CABIN**

1. Service batteries
2. Port engine
3. Common negative

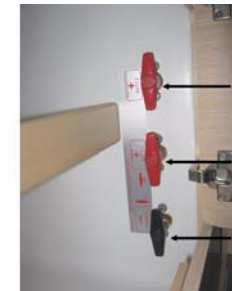

**BATTERY SWITCH
STARBOARD AFT CABIN**

4. Battery coupling
5. Starboard engine
6. Common negative

NAVIGATION

6

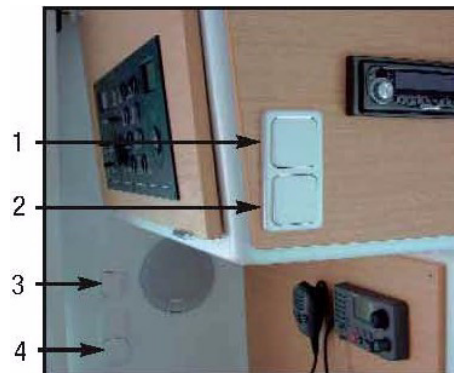

ENTRY SWITCHES

- 1 - Switch - Overhead light - saloon.
- 2 - Switch - Overhead light - galley.
- 3 - Switch - Spot light - Bimini top Rigid (optional).
- 4 - Switch - Overhead light - saloon.

NAVIGATION

■ Getting under way

The sliding door locks in three different positions: closed, ajar (airing position) and open.

A latch on the doorframe enables locking from inside the saloon.

RECOMMENDATION

While sailing block the sliding door shut.

Switch on the main power of the boat by activating the battery switches located in the port and starboard aft cabins, then activate the different accessory switches on the electrical panel.

Check the charge rate of the batteries, the water level in the tanks and the fuel level (see ELECTRICITY and MOTORIZATION chapter).

Carry out the inventory of compulsory safety equipment and instruct the crew concerning its location and operation.

DANGER

Remember to disconnect the shore power supply before casting off.

■ Visibility in navigation

The international regulations to prevent collision at sea (COLREG) and the course regulations make mandatory a permanent and proper surveillance and the respect of priority. Make sure there is no other boat on your way.

The visibility from the steering station may be obstructed in the following conditions:

- Load and load distribution.
- Sea conditions, rain, spray, fog or darkness.
- Lights on inside the boat.
- Persons and removable equipments in the helmsman's field of visibility.

1

NAVIGATION

7

FUEL SUPPLY VALVE

NAVIGATION

8

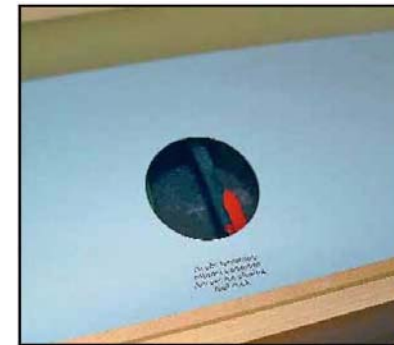

FUEL SUPPLY VALVE

located directly on the tanks

NAVIGATION

■ Navigation under motor

Before starting the engine:

- Ensure that the fuel valves are open.
- Open the valves for the engine cooling systems. (See "Motorisation" chapter).

To start the engines, refer to the manufacturer's manual too.

- ENGINE STARTER

Turn on the battery switches located in the port and starboard aft cabins.

- Disengage the reverse gear (it will make the acceleration possible when in neutral).
- Proceed in the following order:

After starting the engine check for cooling water running out of the exhaust and observe the color of exhaust gases.

- BATTERY COUPLING (OPTIONAL)

In the case of low engine battery power use the battery coupling function by turning on the coupling handle located in the starboard aft cabin.

Once the engines have been restarted make sure that the coupling handle is turned back to its original position.

- NAVIGATION

When the engine is running, avoid making noise and chops near the other users.
Respect speed limits.

WARNING

Never switch off or de-energize the electric system when the engine is running.

1

NAVIGATION

9

RIGHTING MOMENT

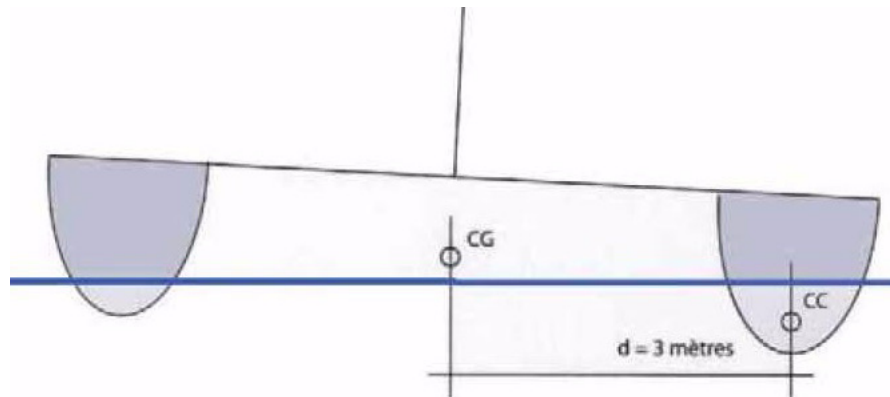

CATAMARAN
Weight of vessel: 10 tons

SINGLE-HULL
Weight of vessel: 10 tons

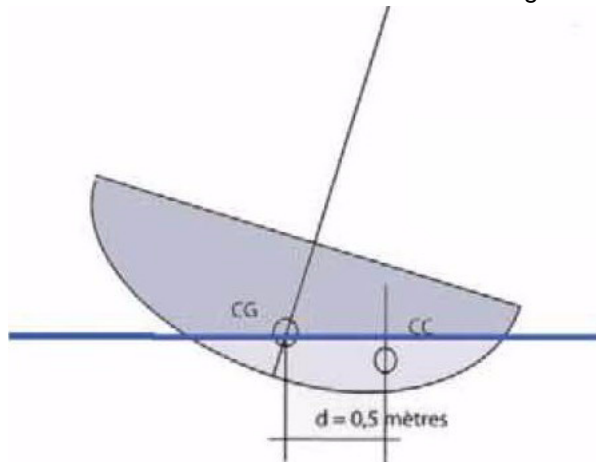

Illustration showing the difference between the righting moments of a single-hull vessel and a catamaran of 10m length.

d: distance between centre of buoyancy and centre of gravity

RMmax: Weight of vessel x d
(RMmax: Righting moment Maximum)

RMmax Single-hull: 10 tons x 0,5 metres
: **5 tons.metres**

RMmax Catamaran: 10 tons x 3 metres
: **30 tons.metres**

■ Navigation under sail

- BEWARE

A catamaran presents 6 times greater heel resistance than a single-hull vessel. In terms of ship design we speak of righting moment (multiplication of the vessel's weight by the transverse distance between the centre of gravity and the centre of flotation (or buoyancy)).

See illustration on previous page.

This fact has real consequences for the handling and sail-trimming of a catamaran.

The fact that the boat will not heel over could conceal an excessive sail surface area in use, which could be dangerous for the crew and the vessel. It is therefore essential to constantly monitor the real wind speed and to trim the sail surface area as a priority in accordance with this speed.

These latter adjustments are valid in calm seas. In rough seas one should take the precaution of reducing 10% earlier in terms of real wind speed. Generally speaking, it is essential to constantly look to relieve the vessel rather than to put it under stress.

One should always look for the sail angle of attack to be headed to the apparent wind and the sails to be not over-trimmed so that the airflows leaving the sail are parallel to each other, that is to say they do not create turbulence behind the sail.

Failure to follow the above recommendations can be dangerous for the boat and the crew, and the manufacturer cannot be held responsible in the event of an accident.

- CLOSE HAULED TRIMMING (between 75 and 50° to true wind)

Given wind force in apparent wind

- **From 0 to 16 knots:** full sail ; mainsail traveler 30 cm to windward of center, mainsail trimmed with a slightly opened leech (boom centered).

The Genoa jib is trimmed near the spreader, the Genoa traveler is placed so that the angle of the Genoa sheet forms a straight line with the clew and the luff, at 40% of its height.

- **From 16 to 20 knots:** full sail ; the mainsail traveler moves up to 60 cm to windward of center, mainsail trimmed with a slightly more open leech (boom still in line: so the sheet will have to be slackened).

The Genoa traveler does not change position but adjust the sheet so that the leech is 10 cm from the spreader.

- **From 20 to 26 knots:** 1 Reef, full Genoa ; the mainsail traveler comes back to 30 cm to windward of center.

The Genoa traveler does not change position but adjust the sheet so that the leech is 20 cm from the spreader.

- **From 26 to 30 knots:** 1 Reef, 75% of the Genoa ; the mainsail traveler comes back to 60 cm to windward of center.

The Genoa traveler remains in place or moves slightly forward but it is adjusted so that the leech forms a propeller, the upper part dumping air out under strong gusts of wind.

- **From 30 to 36 knots:** 2 Reef, 60% of the Genoa ; the mainsail traveler returns to the 30 cm to windward of center, the boom is slackened to fly 50 cm leeward.

The Genoa traveler is moved slightly forward, the adjustment remains the same.

SAILS

NAVIGATION

12

SAILS SURFACE

Mainsail high: 47 m²



Mainsail (classic) 1 Reef: 32,43 m²



Mainsail (classic) 2 Reef: 20,21 m²



Furling genoa: 31 m²

Landmark 1: 24 m²

Landmark 2: 18 m²

Landmark 3: 13,50 m²

NAVIGATION

- **From 36 to 45 knots:** 2 Reef, 40% of the Genoa. The mainsail traveler is dead center and the boom veers 1 meter to leeward. The Genoa traveler moves forward slightly, the sheet is slackened to open wide in strong wind conditions.
- **From 45 to 55 knots:** 3 Reefs alone (either storm sail or lie to), traveler in the center, mainsail out by 1 meter. The boat will be more at ease scudding in this weather.
- **Over 55 knots:** lie to, drag anchor or, preferably, scud bare poles.
- CLOSED REACHED TRIMMING (between 75 and 130° to true wind)
 - **From 0 to 23 knots:** full sail ; the traveler is positioned between 1 meter from centre up to windward of center, depending on the wind angle, the sheet is slackened so that boom is veering out anything from 50 cm in calm weather to 2 meters when the wind is forcing.
In every case no more than one batten should be allowed to chafe at the shroud at the fastest speeds.
The Genoa jib is slackened so that its average attack angle is head on to the apparent wind.
 - **From 23 to 28 knots:** 1 Reef, full Genoa. The adjustments are identical.
 - **From 28 to 33 knots:** 2 Reef, 80% of the Genoa. The adjustments are identical.

- **From 33 to 38 knots:** 2 Reef, 60% of the Genoa. The adjustments are identical.
- **From 38 to 45 knots:** 3 Reef (or mainsail lowered and a little more Genoa), 40% of the Genoa. The adjustments are identical.
- **From 45 to 55 knots:** mainsail lowered, 40 to 30% of the Genoa, sufficiently trimmed so as not to flap.
- **Over 55 knots:** scudding, depending on the sea conditions the mooring lines can be looped round behind the vessel and attached on the opposite side to act as a brake.

These indications are given for your information only and are dependant on outside conditions.

WARNING

Your boat is designed to sail without the need to climb onto the roof for any maneuvers.
It is dangerous to climb or stay on the roof particularly in the event of gibing.
Keep children under close supervision.

1

NAVIGATION

14

LAGOON 380

NAVIGATION

- REDUCING SAIL

The boat is fitted with 2 reefs.
Reefs are automatics.

Putting in reefs n°1 and n°2:

- 1 - Head the boat into the wind.
- 2 - Pull tight the topping lift.
- 3 - Slacken the mainsail sheet.
- 4 - Slacken the mainsail halyard and then trim reef line n°1 or n°2, as needed, until the reefing blocks which correspond to the luff and the mainsail leech are a few centimeters from the boom.
- 5 - Close the line cam cleat of the respective reef.
- 6 - Hoist taut the mainsail halyard.
- 7 - Slacken the topping lift and take in the mainsail sheet.

Refer to the running rigging diagram (chapter on RIGGING AND SAILS) for identification of ropes.

RECOMMENDATION

For safety, the reef line used should always stay on the winch with 3 turns around the drum.
Re-close the cam cleat for greater safety.

- NAVIGATION WIND ASTERN

- Do not fall off more than 150° to the apparent wind.
- Put the traveler out as far as possible and slacken the sheet slightly.
- Make sure the mainsail does not touch the shrouds ; the rubbing of the battens will wear the material and cable very rapidly.
- Keep mainsail + solent up to 15 knots speed and put in one reef or more if the accelerations are sudden and strong or if sea conditions deteriorate.

DECK LAYOUT

NAVIGATION

16

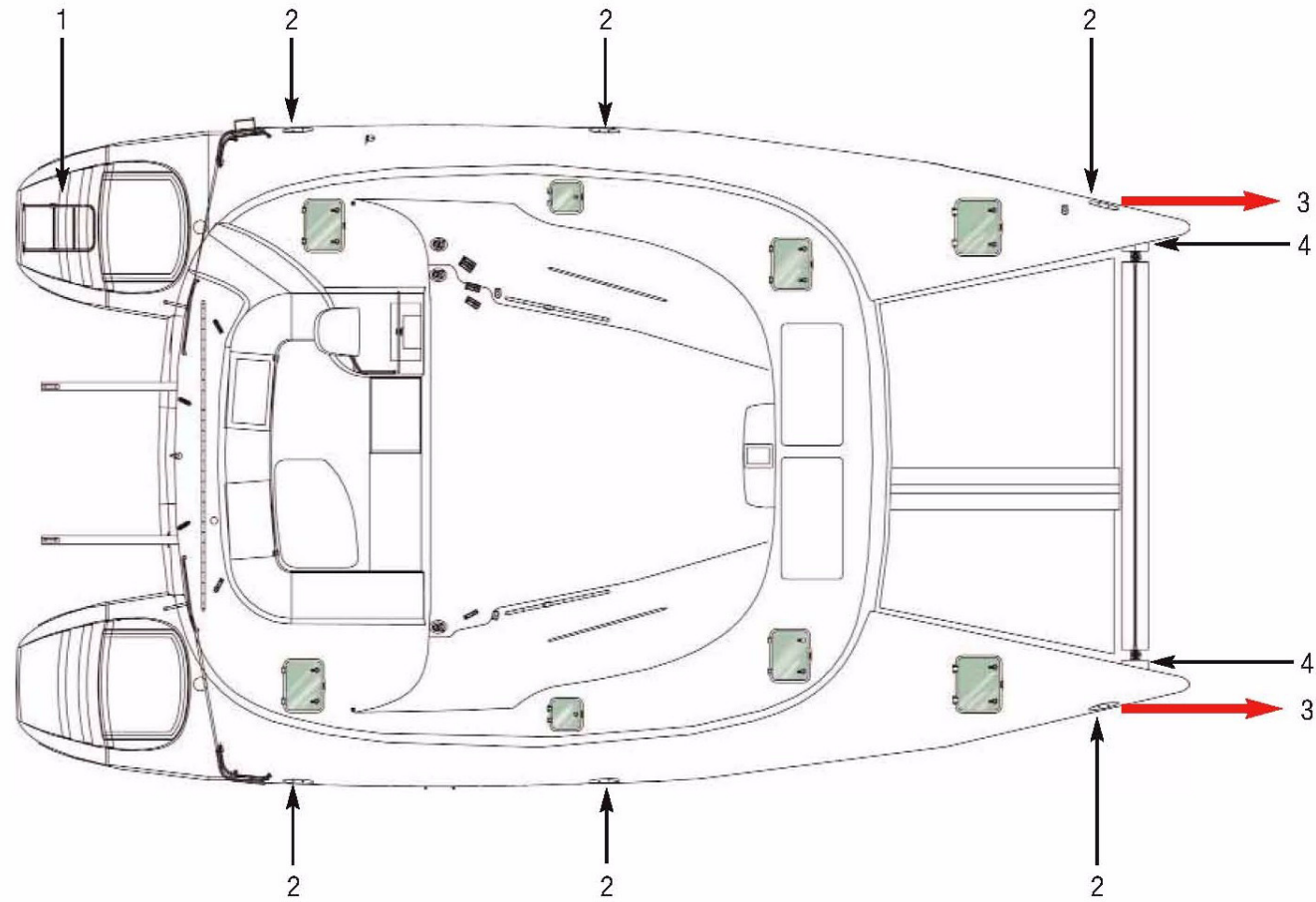

1 - Swimming ladder.

2 - Mooring cleats and Anchoring of lifelines.

3 - Midship cleat for towing.

4 - Anchor bridle fastening.

NAVIGATION

■ Mooring

A sufficient number of mooring lines suitably sized and suitable for the environment shall be on board for mooring your boat.

- Always manoeuvre your boat using the engine.
- Make allowance for the current and wind when you handle your boat.
- Protect your boat to the highest degree with suitably sized fenders.
- Always keep the mooring ropes unfouled and stored away.
- Handle your boat at a reduced speed.

DANGER

Don't try to stop the boat with your foot, your hand or a boat hook.

AFTER MOORING

- Protect the mooring lines against chafing with plastic sleeves.
- Make allowance for the variations in tides if need be.

■ Towing

TOWING BOAT

- Tow another boat at a reduced speed and as smoothly as you can.
- Pay particular attention when you throw or catch the towing rope (it may foul on the propeller).

NOTE: The stability may be reduced when you tow a boat.

TOWED BOAT

- Keep steering your boat and see to it that you stay in the wake of the towing boat.

■ Anchoring

As a rule, set the anchor in at least 3 times the depth of water.

RECOMMENDATION

Before anchoring check the depth of water, the power of the current and the nature of the sea bed.

- PREPARATION OF ANCHORING (Illustrations following page)
 - Install the bridle by fixing it to the chain plates located at the ends of the fore beam.
 - Put the bridle through the stem bow roller.
 - Shackle the bridle to the central cleat during the lowering of the chain.
- MANUAL ANCHORING
 - Have your boat pointed into the wind and without speed.
 - Release the brake on the chain lifter.
 - Pay out the chain while moving back slowly.
 - Secure the anchor chain on the bridle.
 - Lead out the chain until the guy becomes taut.

ANCHORING



ATTACH THE BRIDLE TO THE FORWARD BEAM



RUN THE BRIDLE THROUGH THE BOW ROLLER



SHACKLE THE BRIDLE TO THE CHAIN

NAVIGATION

18

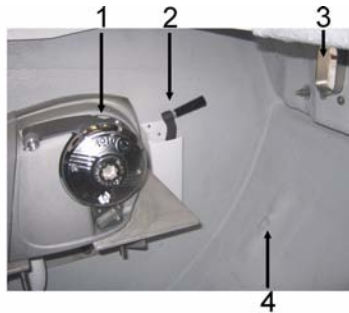

1. Windlass 12V
2. Handle (The handle is used to disengage the chain rim brake and to haul in the anchor manually in the case of electrical breakdown)
3. Hawse
4. Clench



WINDLASS CONTROL



**WINDLASS CIRCUIT BREAKER 100A
(PORT AFT CABIN)**

NAVIGATION

- WINDLASS ANCHORING

WARNING

Nobody should be aboard the tender during maneuvers carried out with the davits.

- Release the gypsy brake.
- Activate the windlass with the control located in the saloon.

- HEAVING UP THE ANCHOR

- Lock the cable lifter snubber.
- Ensure the chain is properly set on the cable lifter.
- Slowly go near the anchor, using your engine (Don't use your windlass to winch the boat).
- Release the bridle from the chain.
- Heave the anchor completely.
- Visually check the last meters till the anchor gets into contact with the davit.
- Secure the anchor or anchor chain to the cleat.
- Release the anchor clutch.

WARNING

Windlass operations are dangerous:

- Always keep the anchor line unfouled and free.
- Always proceed with care, using gloves and always wearing shoes.

In the case of electrical failure use the winch handle on the windlass to lift anchor.

- MAINTENANCE

After each trip rinse the windlass and mooring line with fresh water.

Refer to the manufacturer's instructions for windlass maintenance at the beginning or end of the season.

DAVIT

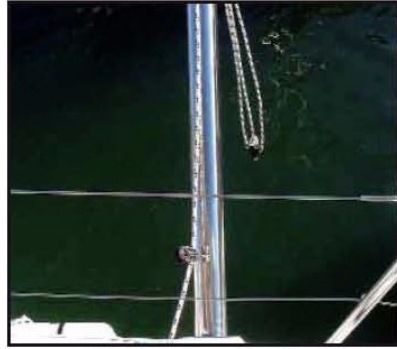

DAVIT



DAVIT BLOCKERS



ATTACH DAVIT LINES

■ Davit (optional)

WARNING

Nobody should be aboard the tender during maneuvers carried out with the davits.
Tie up the tender out of the way during maneuvers.

- INSTALLING A TENDER ONTO THE DAVITS
 - Fix the davit line hooks to the forward and aft of the tender.
 - Close the blockers found on the davits.
 - Pull the bow of the tender up to halfway using the cockpit winch.
 - Repeat the operation for the stern.
 - Alternatively raise bow and stern until the tender comes into contact with the davits.
- LAUNCHING A TENDER FROM THE DAVITS
 - Ensure that the blockers on the davits are closed.
 - Thread the davit rope attached to the stern of the tender around the winch (minimum of 3 turns).
 - Open the blocker and let the line feed out until halfway.
 - Close the blocker.
 - Repeat the procedure for the bow.
 - Alternatively lower stern and bow until the tender comes into contact with the water.

WARNING

When under sail remove the tender engine and store it on board the boat.
Secure the tender according to sea conditions.

WARNING

The davits are designed to support a load of 260 kg at maximum.
The weight of the appendix does not have to exceed 150 kg.

■ Environment

RECOMMENDATION

We share a love for the ocean. Help us to preserve them !

Do not discharge oil into the sea.
Take every precaution to prevent hydro-fuel overflow when filling the engine tank.

When in port, only use the onboard toilets if they are equipped with organic waste reservoirs.

The use of detergents is implicated in the destruction of marine plant and animal life. Choose fully biodegradable cleaning products. Do not throw plastic bags and bin bags into the sea. Use the bins provided for this purpose at ports.

Winter Storage

2

LAYING UP	25
PROTECTION AND MAINTENANCE.....	25

BLOCKING THE BOAT ASHORE

WINTER STORAGE

24



LAGOON 380

WINTER STORAGE

■ Laying up

- Take ashore all the ship's documents, any lines that are not used for mooring, galley equipment, supplies, clothes, safety equipment, batteries and gas bottles.
- Mark again the safety equipment, check the expiration dates, have the liferaft overhauled.
- Take advantage of this laying up to draw up a complete inventory of the equipment.

• BLOCKING THE BOAT ASHORE

Preparation for each hull:

- A large rectangular wooden block of 1 m in length and a tire to be placed under the stern, across the keel.
- A steel jack-stand of a minimum of 1 m in height which will be placed under the forward part of the forward bulkhead.

Make sure that the aft part of the keel is well-chocked (on its block) before very carefully lowering the forward section onto the jack-stand.

■ Protection and maintenance

• INSIDE

- Drain all the fresh water pipes and rinse them with water and vinegar (do not use a chlorine based product).
- Lubricate and close all the water inlet valves and thru-hull fittings. Rinse and completely drain the heads bowls and pumps.

- Retract the sounder and speedometer sensors.
- Seal air inlets as much as you can.
- Install an atmosphere dehumidifier in the saloon and leave the cabin and storage unit doors open (lockers, ice boxes).
- Leave the cushions outside for long before putting them back into the boat in the upright and side position in order to have minimum contact surfaces.
- During long absence leave the fridge and icebox doors open to avoid mould developing.
- Installed in the square of a dehumidifier air leaving the cabin doors and open storage (cupboards, coolers).

• OUTSIDE

- Thoroughly rinse the hull and deck.
- Lubricate all the mechanical and mobile parts with vaseline (bolts, hinges, locks etc.).
- Protect all ropes and mooring lines against chafing.
- Protect the boat to the highest degree with fenders.
- Make sure the boat is properly moored.
- Bring the removable cushions inside (washed with soapy water then dried) when the vessel is inoccupied.

All these recommendations do not make up an exhaustive list. Your dealer will give you the advice you need and will carry out the technical maintenance of your boat.

• ENGINES

RECOMMENDATION

Winter storage of the engines is the domain of professionals. Depending on the boat location, afloat or ashore, winterization is different.

Launching

3

RECOMMENDATIONS	29
STEPPING THE MAST	31

POSITIONING OF HOISTING STRAPS

LAUNCHING

28

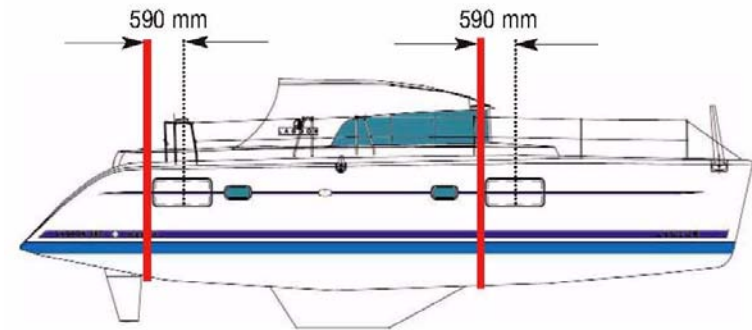
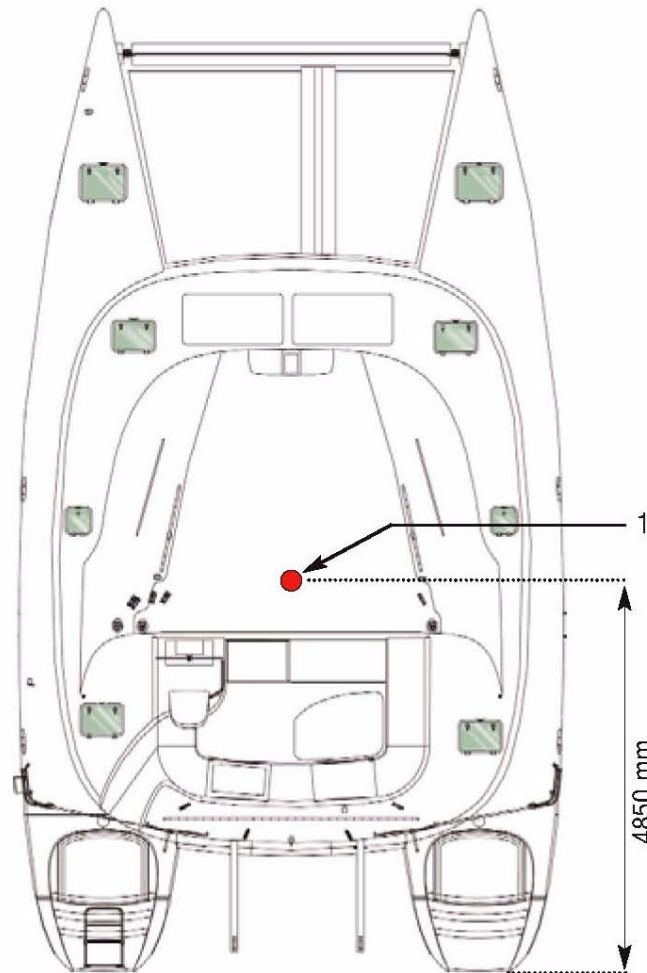

1. Centre of gravity.

LAUNCHING

■ Recommendations

A lot of skill and care is required to commission your LAGOON boat. The proper working of all your boat equipments in the future results from the quality of the commissioning operations.

The initial launching and the first tests of the different equipments shall be carried out by your LAGOON dealer or agent so you can expect to enjoy the warranty in case of some equipment failure.

RECOMMENDATION

All future maintenance should be carried out with the greatest care by professionals.
If the LAGOON boatyard is not involved in maintenance operations, your guarantee will not cover any incidents linked to handling errors.

- BEFORE LAUNCHING

- If your boat is to be fitted with sounder and speedometer, allow for the relevant fittings and their installation.
- Check the water intake strain box for cleanliness.
- All the optional accessories shall be sealed with paste.
- Retract the speedometer into its housing (it may be damaged by the handling belts).
- Turn off all the water inlet and drain valves (sink, washbasin, heads, engine).

- HOISTING

Install a fore rope, a rear rope and fenders.

Prepare:

- 2 Straps (minimum 11 meters).
- 4 slings.
- Attach the 4 slings to the belts.
- Put it slightly under tension ; the sling hooks should be situated at the boat's centre of gravity.

3

LAUNCHING

29

PACKING

FURTHER INFORMATION RELATIVE TO THAT GIVEN IN THE GENERAL SPECIFICATIONS CHAPTER

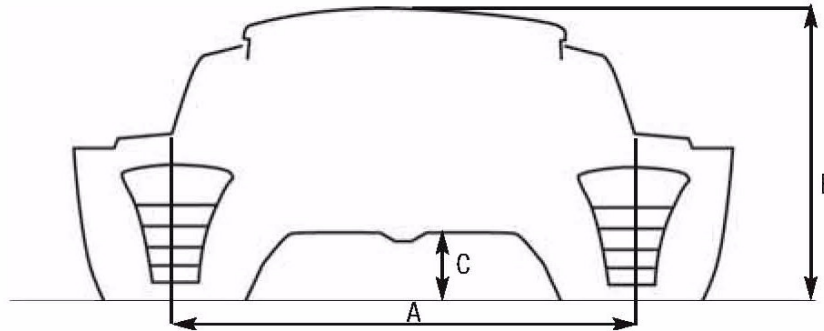
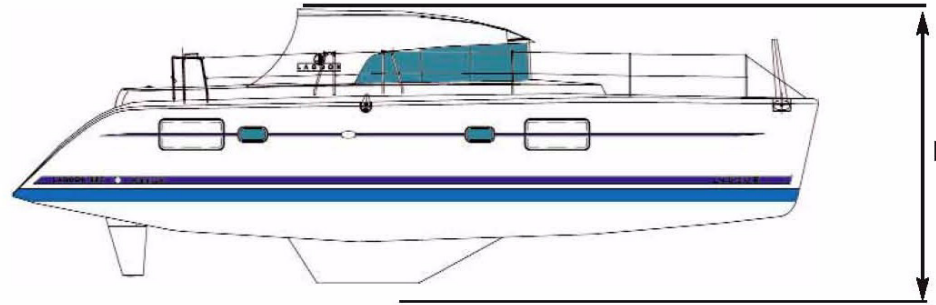

Reference	Designation	Size (m)
A	Width between hull centers	4,50
B	Air draught (without mast or appendices)	2,85
C	Waterline height under nacelle	0,72
D	Vessel height on its keels (without mast or appendices)	4,08
	Length of boom	3,40
	Length of Europe mast	15,45

LAUNCHING

Hoist gently, and control the movement of the boat with dock lines.

DANGER

Do not stay on board or under the boat during hoisting.

RECOMMENDATION

Never place belts or fenders in contact with the large glass windows in the hulls.

- AFTER LAUNCHING
 - Check the sounder and speedometer fittings for tightness if need be.
 - Open the valves and make sure that they are tight with the hull and relevant hose.

Before starting the engine, refer to the MOTORIZATION chapter.

■ **Stepping the mast**

If later you have to step the mast anywhere other than at your LAGOON dealer:

- BEFORE MAST INSTALLATION
 - Protect the mast against possible chafing by the crane hook and cable.
 - Tie down the shrouds and all the riggings to the base of the mast with a lashing long enough to guide the mast heel when stepping the mast.
 - Protect the spreader end fittings and the roller furler drum.
 - Put a rope of about 1,50 with an eye and thimble at both ends and covered with rags round the mast. Place the rope under the second tier of spreaders.
 - Link together both thimbles (that are ahead of the mast) with a shackle large enough to receive the crane hook.
 - Raise the whole till it is taut under the spreader bases.
- DURING MAST INSTALLATION
 - Take the necessary steps to avoid damaging the mast head equipments.
 - Use the backstay and lashing at the base of the mast to control the handling.
 - Engage the electrical harness in the mast base.
 - Make sure the base of the mast integrally bears on its base plate.

3

LAUNCHING

31

MAST JUNCTION BOX

LAUNCHING

32



LAUNCHING

- AFTER MAST INSTALLATION

- Lubricate all the bottle screws (see recommendations in the RIGGING chapter).
- Stretch tightly the rigging (refer to RIGGING chapter for settings).
- Reconnect the electrical cables in the junction box at the base of the mast located in the forward cockpit locker after running the cables through the gooseneck located at the front of the mast (see ELECTRICITY chapter).
- Carefully check the tightness of the turnbuckle cotter pins, and protect with adhesive tape.
- Put the boom back. Refit all ropes.

RECOMMENDATION

Adjust the mast after a few trips.

- UNSTEPPING THE MAST

Proceed by carrying out the operations recommended for stepping the mast in reverse order, taking care to mark the line locations with stickers.

RECOMMENDATION

Before all dismasting operation, remember to disconnect the electric cables
Pull gently while guiding the cables.

3

LAUNCHING

33

Hull & Deck

4

CONSTRUCTION.....	37
MAINTENANCE.....	37
CARRENING	37
GEL-COAT REPAIR	39
STEERING GEAR.....	39

CARREENING

HULL
& DECK

36

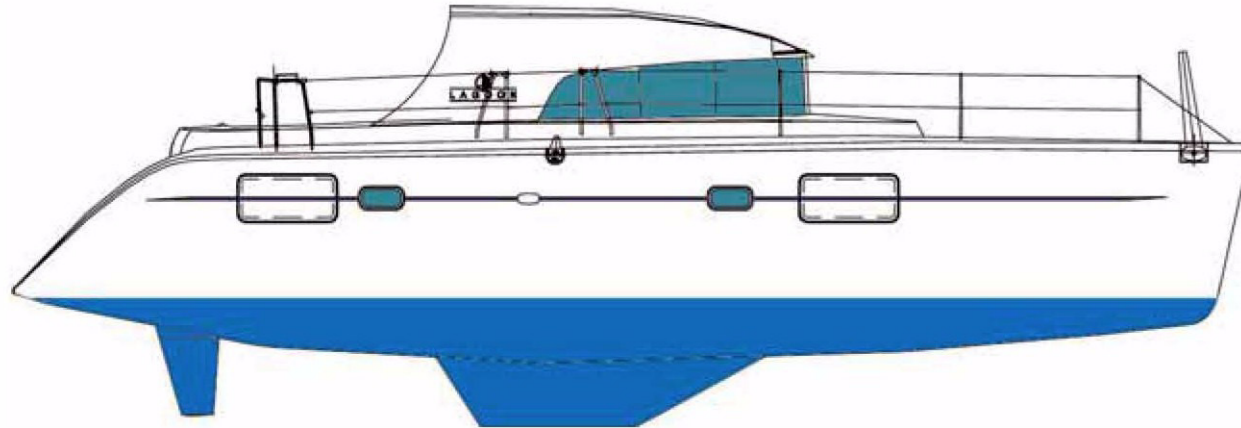

Wetted area (including appendices): 44 m²

HULL & DECK

■ Construction

The LAGOON 380 is built of balsawood sandwich (monolithic below the water line), polyester resin and vinyl-ester; the counter-mould sare monolithic and the partitions are made of laminated plywood.

The nacelle and deck are of balsawood sandwich composite.

■ Maintenance

The materials and equipments of your boat have been selected because of their high quality and performance and ease of maintenance.

However you shall carry out a minimum maintenance in order to protect your boat from outside attacks (salt, sun, electrolysis ...).

Preferably wash your boat on shore.

Use as few cleaning agents as possible.

Don't use solvents or aggressive detergent agents.

Don't discharge your cleaning product into the water.

Regularly brush the deck with a degreasing shampoo and fresh water.

RECOMMENDATION

We strongly advise you against using a pressure washer.
You shall not use hot water or steam.

DECK FITTING

- Rinse thoroughly all your equipments with fresh water.
- Periodically lubricate blocks, sheaves, bottle screws, winches, rails and travellers with a water-repellent grease.

- Stainless steel that is showing small spots or blisters of rust should be cleaned and polished with a chrome and steel renovator.

SOLID WOOD ON EXTERIOR WOODEN PANELLING

Regularly clean the woodworks with fresh water using a sponge (if need be add some gentle soap).

PLEXIGLAS

- Rinse plexiglas with fresh water.
- Brighten up with a soft rag soaked with liquid paraffin.
- Use polish paste to remove scratches.

EXTERIOR CUSHIONS

Bring the removable cushions inside (washed with soapy water then dried) when the vessel is inoccupied.

STAINLESS STEEL

Stainless steel is not incorruptible and requires a minimum of upkeep:

- The use of chrome tools is preferable whenever handling stainless steel.
- Re-nourish the protective film regularly with passivation paste (consult your dealer).

■ Carreening

A (tin-free) anti-fouling painting every year will make it possible to avoid tedious and frequent careening. An epoxy coat is recommended beforehand. You are reminded that any excessive sanding before your antifouling paint attacks your gel coat and impairs its reliability.

Your boat may regain her shine as new if polished. If a lasting and isolated problem arises, contact your dealer.

STEERING GEAR

HULL
& DECK

38

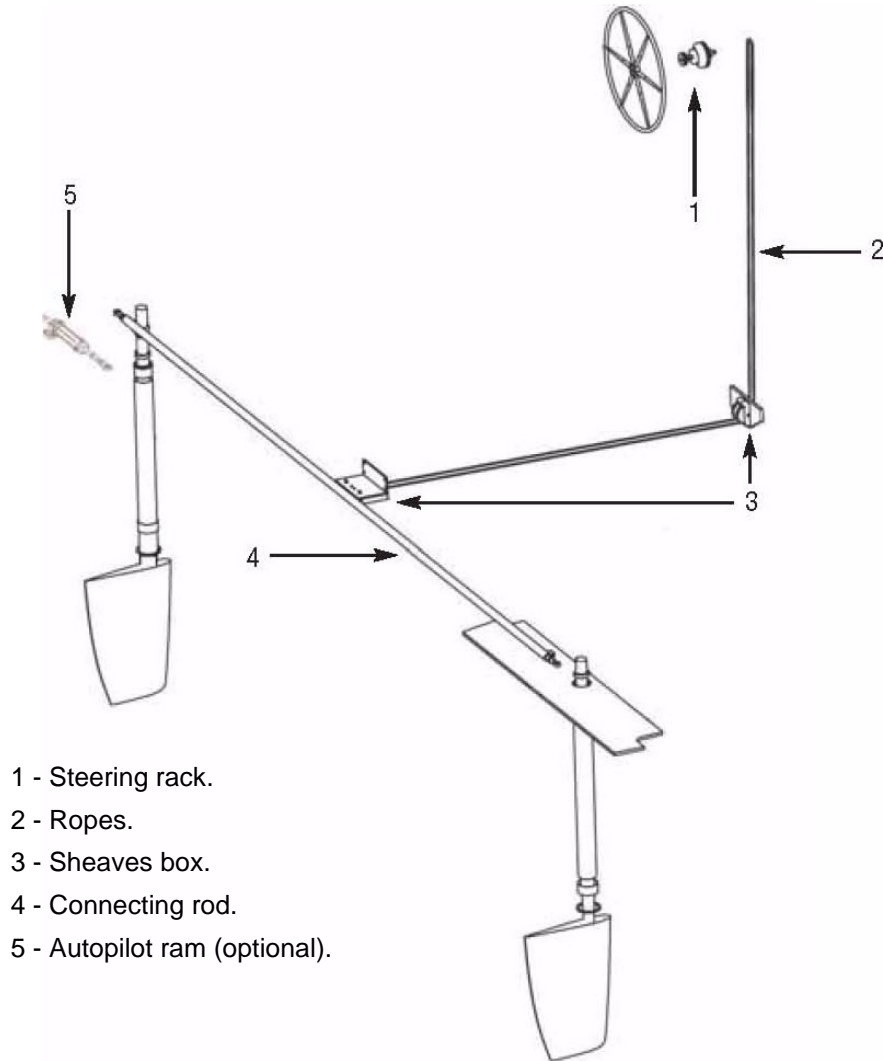

- 1 - Steering rack.
- 2 - Ropes.
- 3 - Sheaves box.
- 4 - Connecting rod.
- 5 - Autopilot ram (optional).



CABLE TENSION SYSTEM

HULL & DECK

■ Gel-coat repair

MIXING RATIO

Our products contain an accelerator, you just have to add the catalyst (a colourless liquid). The usual ratio is 2 %.
The gel setting time (working time) is about 1/2 h, curing takes about 10 h.

WARNING

Please respect the following conditions to repair successfully:

- Dry weather.
- Temperature between 15° C and 25° C.

APPLICATION

- To fill up a blister hole or a scratch, sand and clean the area with acetone.
- Prepare the necessary amount of gel coat, preferably on a glass plate.
- Apply the product with a spatula or a point and the layer shall be thick enough to make possible a further sanding.
- In order to blend minor touching up on smooth surfaces, stick sellotape (or even better, a mylar tape) on the freshly applied gel coat.
- Remove sellotape after curing.
- To get a highly shiny finish, sand with extra fine abrasive and water then polish.

STORAGE

To keep them properly, store the gel coat components in a cool dry and dark place.

Keep the components 6 months maximum.
Polyester products are flammable ; take the usual precautions.

CLEANING YOUR TOOLS

Clean all your tools with acetone.

DANGER

The catalyst is a dangerous product:

- Keep it out of the reach of children.
- Avoid contact with skin and mucous membranes.
- In case of contact wash with soapy water and rinse thoroughly.

■ Steering Gear

The steering system is accessed via the engine compartment.

- Regularly check its tension.
- Don't tighten the steering cables excessively.
- Lubricate all the elements.

Maintain the nylon, ertalon or teflon bushes only with a suitable lubricant.

Proper settings result in gentle steering resistance, without hard points and without looseness.

INTERIOR MAINTENANCE.....	43
FABRICS.....	43
COCKPIT TABLE, SERVING HATCH, COOL BOX	45
PORTHOLES AND DECK HATCHES.....	45
WATER COOLED REFRIGERATION UNIT (OPTIONS)	47
HEATING (OPTIONAL)	47

INTERIOR

INTERIOR

42



3 cabin version.



4 cabin version

INTERIOR

■ Interior maintenance

- Take advantage of the fine weather to take the settee and berth cushions out.
- Put the cushions vertically if you leave the boat for long.
- Use blinds to protect the inside of the boat against UV rays.
- Make sure the bilges are clean and dry.
- **INSIDE VARNISH**
 - Rinse the inside varnish with fresh water mixed with spot remover and shampoo.
 - Polish the inside varnish with shammy leather.

RECOMMENDATION

Use as few cleaning agents as possible.
Don't discharge your cleaning product into the water.

■ Fabrics

ADVICE: Mark up each cover and foam when dismantling.

- **STAIN REMOVAL**
 - Dab with a clean rag.
 - Remove the stain with solvent on a clean rag. Never pour the solvent directly over the stain.

- Rub with a clean and dry rag.
- Brush the fabric against the grain.
- Use the vacuum cleaner when the fabric is dry.

PVC OR COATED FABRICS

- Use a sponge and water and soap (household soap type).
- Dab away resistant stains with a rag soaked with white spirit, do not rub them.

RECOMMENDATION

For the PVC fabrics, don't use any solvent or solvent based product (pure alcohol, acetone, trichloroethylene).

100% POLYESTER/DRALON JACQUARD

If you cannot remove the fabric:

- Clean with the vacuum cleaner.
- Clean with synthetic foam (please refer to the product instructions).

If you can remove the fabric:

- Hand wash with an ordinary washing powder at 30° C.

In both cases, dry cleaning is possible. Remove the stains as soon as possible with a damp rag.

SERVING HATCH - COOL BOX - DECK HATCH

INTERIOR

44



SERVING HATCH



COOL BOX REMOVABLE



LOCKING DECK HATCH
(Button handles in open position)

INTERIOR

COTTON JACQUARD

- Dry clean.
- Do not iron.
- Do not use hypochlorite.
- Remove the stains with fractionated petrol.

■ Cockpit table, Serving hatch, Cool box

As an optional extra the cockpit can be fitted with a large polyester table.

The square tables and cockpit are interchangeable.

Open and fasten the sliding sash using the inside latch before unfolding the serving hatch shelf.

A removable igloo icebox is located in the forward cockpit locker.

■ Portholes and deck hatches

The portholes and deck hatches are equipped with latch systems to keep them in a closed position.

At mooring, intermediate opening positions allow for airing of the boat.

REFRIGERATION UNIT - HEATING

INTERIOR

46



FRIDGE

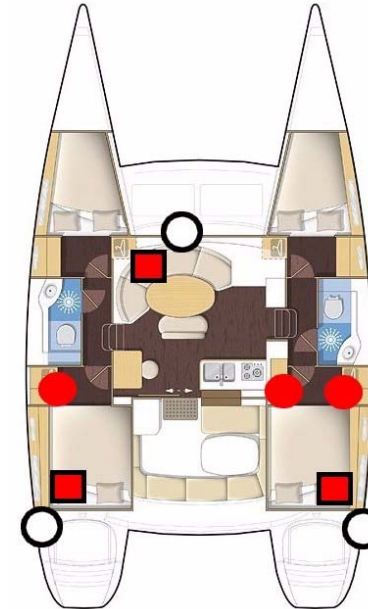

HEATING



1. Drainage - Refrigeration unit

-  Boiler - Diesel
-  Heater exhaust outlet
-  Control

INTERIOR

■ Water cooled refrigeration unit (Options)

Before turning on the refrigerator:

- Open the seawater cooling intake valve located under the gangway floor in front of the starboard aft cabin.
- Open the draining valve located under the cabinet in front of the starboard aft cabin.
- Defrost the fridge regularly.
- During long absence leave the fridge and icebox doors open to avoid mould developing.

■ Heating (optional)

The heating system works on 12 V.

It consists of 3 boilers located under the forward bench seat of the saloon and in the locker under each aft berth.

The port hull and saloon boilers are supplied with diesel from the port tank.

The starboard hull boiler is supplied with diesel from the starboard tank.

To operate the system:

- It is on 12 V supply as soon as the boat's power is turned on (Battery switch of house system).
- Turn on the heaters with their controls and then set the desired temperature with the thermostats.

For use and maintenance of the material consult the manufacturer instructions.

Electricity

6

BATTERIES - BATTERY SWITCH.....	51
USE OF 12 V CIRCUIT	53
110 V - 220 V SYSTEM.....	55
TECHNICAL ROOM.....	55
BATTERY CHARGER	55
SHORE POWER SOCKET	57
MAST HARNESS.....	57
ELECTRONIC	57

ELECTRICAL LAYOUT

ELECTRICITY

50

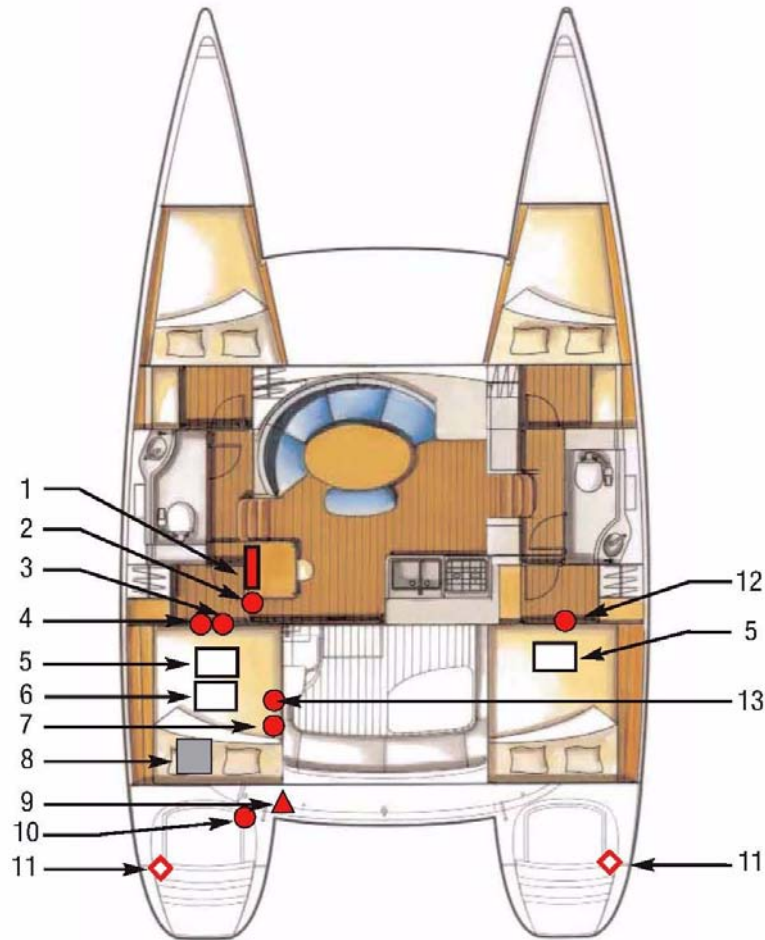

1. Electrical panel.
2. 110 V - 220 V breaker.
3. Battery switch engine + House.
4. Windlass circuit breaker.
5. Battery stock - engine 12 V.
6. Battery stock - house 12 V.
7. Battery charger.
8. Water heater.
9. Shore/house power.
10. Shore power supply circuit breaker.
11. Ventilators.
12. Battery switch + Coupling drivers.
13. Charge divider.

The positions are the same for the other layout version.

ELECTRICITY

■ Batteries - Battery switch

The electricity onboard is 12 V DC.

The electrical system consists of service batteries. The batteries supply power to all the functions on board (see SPECIFICATIONS chapter for battery capacity).

The general 12 V system is turned on by switching to ON the battery switches located in the port and starboard aft cabins.

- MAINTENANCE

Keep the batteries charged enough (essential to ensure them a correct service life).

It is possible to operate with the battery store charged to 80% on the condition that the batteries are charged weekly to 100%.

The discharge of the batteries must not exceed 70% of the rating.

To start navigating with batteries loaded properly, and enjoy the holidays to use the dock or charger choose a selection mode that allows the operation of the generator.

A battery monitor (DC meter on the electrical panel) enables control of the charge, voltage and depletion rate of the service batteries and of the generator (optional).

For its use see the instruction guide.

Always check the battery and charge system condition before you put out to sea.

Keep the batteries clean and dry in order to avoid premature wear.

Have the acidity level of the battery checked if unused for long.

Check the level regularly.

Tighten and maintain the terminal connectors lubricating them regularly with vaseline.

WARNING

**A damaged battery will never recover its original capacity.
The service batteries should be charged to their maximum.**

6

ELECTRICITY

51

ELECTRICAL PANEL

ELECTRICITY

52

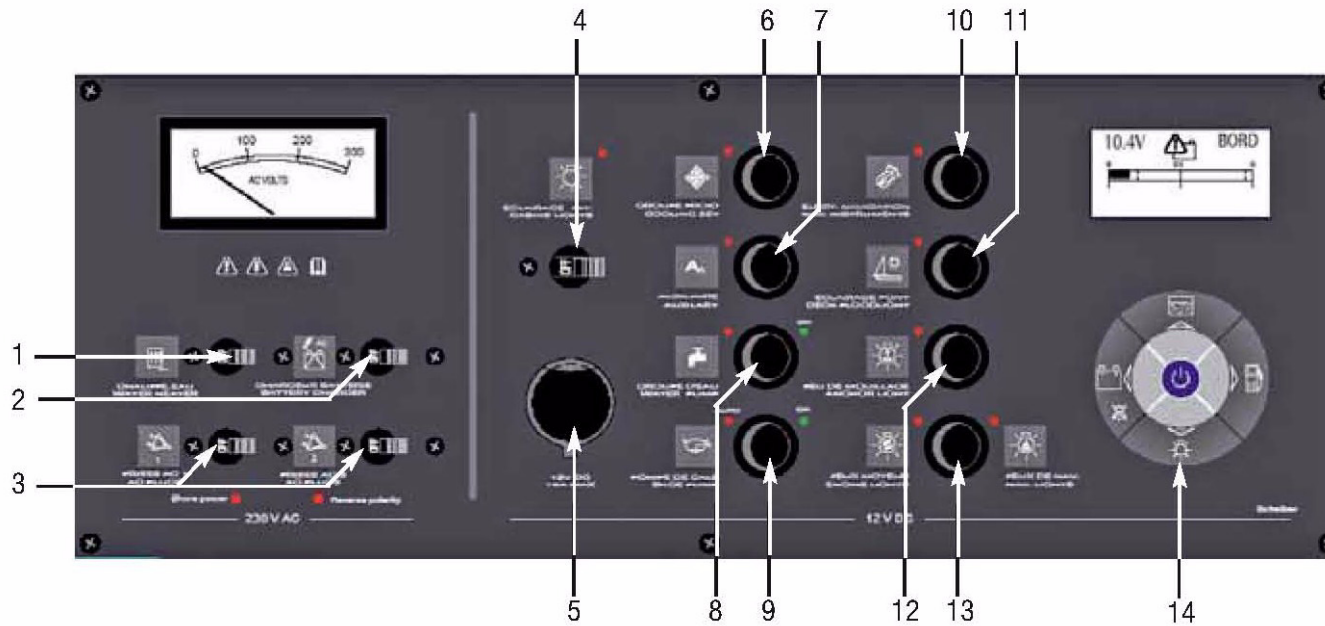

1. Water heater 220 V AC.

2. Water heater.Battery charger 220 V AC

3. Sockets 220 V AC.

4. Interior lighting.

5. Socket 12 V DC.

6. Fridge.

7. Comfort (Waste water pump).

8. Water unit.

9. Bilge pump.

10. Navigation station.

11. Deck light.

12. Mooring light.

13A. Navigation lights.

13B. Steaming light.

14. Selector gauge - water and fuel, battery.

ELECTRICITY

■ Use of 12 V circuit

RECOMMENDATION

Never leave the boat unattended when the electric fitting is on (except the safety equipments directly connected to the battery and protected by a circuit breaker).

In case an electric appliance is not energized, check:

- The main power supply.
- The switches and circuit breakers on the line.
- the relevant electrical unit.

WARNING

Never work on a live electric fitting.

RECOMMENDATION

- Never modify an electric fitting and relevant diagrams yourself.
- Call in a technician skilled in marine electricity to carry out any electric modification.
- Never change the breaking capacity (amperage) of the overcurrent safety devices.
- Never install or replace the electric appliances (or any electric equipment) by components exceeding the capacity (amperage) of the circuit (Watt for bulbs).

6

ELECTRICITY

53

220 V BREAKER - CHARGER - JUNCTION

ELECTRICITY

54

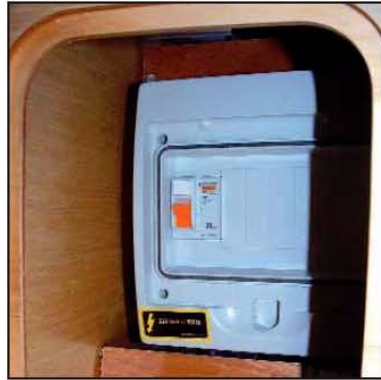

220 V BREAKER
(in the cupboard to the rear of the port gangway)

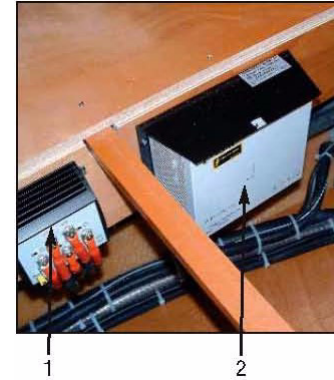

1. Charge divider.
2. Battery charger 220 V // 12 V.

ELECTRICITY

■ 110 V - 220 V system

The different electrical devices which work on 110 V - 220 V supply have their switches grouped together on the right hand side of the electrical panel.

- PROTECTION

Connect the metallic covers or boxes of the electric appliances that are installed to the protective conductor of the boat (green conductor with yellow stripes).

■ Technical room

The service compartment where the fuses are located is situated behind the electrical panel. To access this area lift up the plate above the electrical panel in order to unclip it (2 clips), then pull it towards you to remove the plate from the end groove into which it is fitted.

■ Battery charger

The battery charger can be used with the shore supply function. Access to it is gained through the locker under the port aft berth. Turn on the charger with the circuit breaker on the electrical panel.

Concerning use and maintenance of the charger refer to its instructions.

6

ELECTRICITY

55

SHORE POWER SUPPLY CIRCUIT BREAKER

ELECTRICITY

56

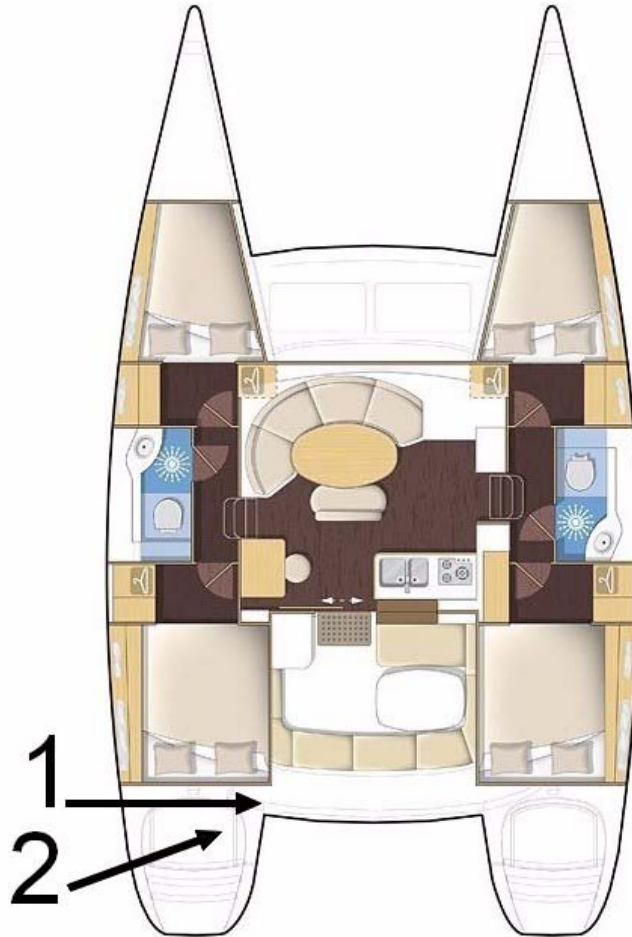

220 V SOCKET
(Landmark 1)



220 V BREAKER
(Landmark 2)

The positions are the same for the other layout version.

■ Shore power socket

DANGER

Never let the end of the boat/shore supply cable hang in the water: The result may be an electric field liable to hurt or kill the swimmers nearby.

RECOMMENDATION

In order to reduce the risks of electric shock and fire:

- Before you plug in or unplug the boat/shore supply cable, switch off the shut off device connected to the shore supply.
- Plug in the boat/shore supply cable in the boat before you plug it into the shore supply socket.
- Unplug the boat/shore supply cable on shore first. Close the shore socket cover.
- Do not modify the connections of the boat/shore supply cable.

■ Mast harness

During mast-stepping insert the cables through the base of the mast.

The connection is made at the switch box on the mast bulkhead. See LAUNCHING chapter.

■ Electronic

Do not install electronic instruments or repeaters less than 1,50 m away from the radio loudspeakers, if your boat has them.

Do not place the autopilot compass less than 0,50 m away from the electrical harnesses.

RECOMMENDATION

For your electrical requirements, we recommend you consult a specialist or our network of technicians.

- ELECTRONICS PACKS (OPTIONS)

Different electronics packs are offered on option.

Plumbing

7

WATER TANKS	61
FRESH WATER SYSTEM	61
GAS SYSTEM	63
DRAINAGE SYSTEM	63
SANITARY EQUIPMENT	65

FRESH WATER AND GAS

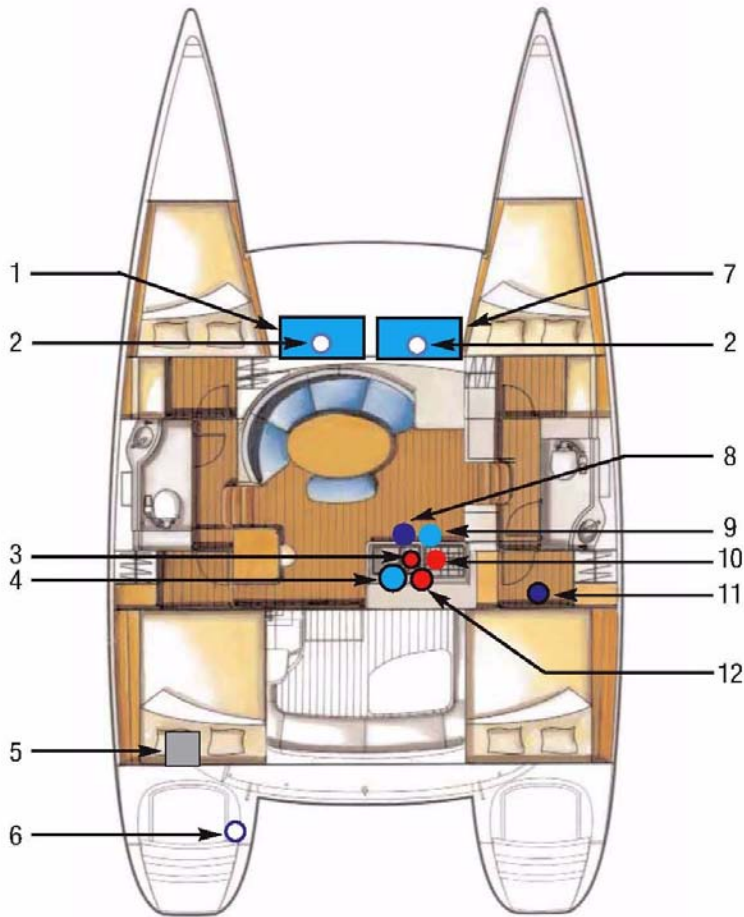

1. Forward port tank (optional).
2. Deck filler
3. Selection valve - Shore fresh water / Tanks (optional)
4. Water unit + Accumulator tank
5. Water heater
6. Shore power socket - Fresh water (optional)

7. Forward starboard tank
8. Foot pump / Sea water (optional)
9. Foot pump / Fresh water (optional)
10. Gas valve
11. Seawater intake valve / Optional equipment Foot pump
12. Valves for tank selection To port / To starboard (optional)

PLUMBING BOARD



VALVES FOR TANK SELECTION



The positions are the same for the other layout version.

PLUMBING

■ Water tanks

• FILLING

In order to prevent any handling mistakes, never fill the water and fuel tanks at the same time.

During filling, avoid handling contaminants near the fillers.

Open and close the filler caps with the suitable key.

Check the filler cap seals for condition during filling.

The tanks are fitted with overflow outlets and vents.

Never insert the water filling hose deep down into the system in order to prevent any over-pressure in the systems.

• MAINTENANCE

RECOMMENDATION

- Pay attention to the quality of the water for the filling up. Check if it is drinking water.
- It is possible to sterilize the tanks with a Clonazione tablet (sold at the Chemist's).
- If the boat is not used for long, purify the tanks and pipes with acetic acid (or white vinegar).

Inspection ports are provided on tanks and make possible the cleaning of the inside.

NOTE: It may happen that the capacity of the fresh water tank or tanks indicated on the page "Specifications" cannot be completely used depending on the trim and load of the boat.

■ Fresh water system

The water pump is switched on at the electrical panel.

The 3 way valve enables the water system source to be switched from the starboard tank to the port tank (optional).

For optimisation of use of fresh water completely use up one tank's supply before switching over to the other..

RECOMMENDATION

- Never operate the water system equipment when the valve is closed or the tank is empty (the electrical equipment may be damaged).
- Check the water filter for condition (refer to manufacturer's instructions).

• SHORE POWER SOCKET FRESH WATER (OPTIONAL)

The vessel may be equipped with a connector for the shore supply off reshwater.

The nozzle on the port transom extension enables a hose to be connected to supply the onboard system from a quayside freshwater hydrant.

WARNING

- Turn off shore water before leaving the vessel.



WASTE WATER SYSTEM

PLUMBING

62

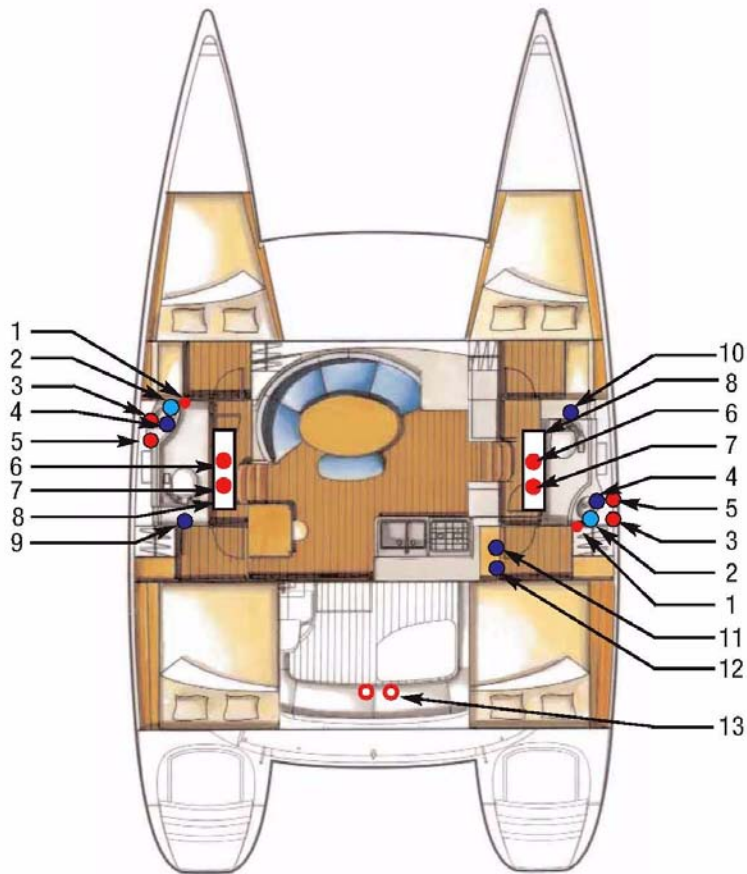

1. Switch - shower pump
2. Suction valve WC
3. Pump - Shower draining
4. Valve - Washbasin draining
5. Electric bilge pump
6. Drainage valve for forward watertight compartment
7. Drainage valve for aft watertight compartment

8. Sump
9. WC evacuation / Sewage tank - To port
10. Valve - Forward starboard toilet drain
11. Vannes - Icebox drainage
12. Vannes - Sink draining
13. Manual bilge pump

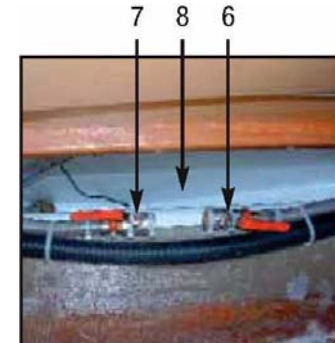
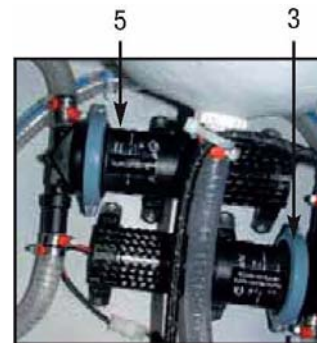

The positions are the same for the other layout version.

PLUMBING

■ Gas system

Refer to the SAFETY chapter.

Refer to "Fresh water and gas" diagram.

When changing the cylinder, refit the cap in place on the regulator threaded section (to avoid corrosion).

RECOMMENDATION

Shut off the gas safety valve and the regulator tap when the stove is not in use.

■ Drainage system

A main sump well is located under the floor of each hull.

It is drained by:

- A manual bilge pump in cockpit.
- An electric pump to automatic sump located in the sump.

The fore compartments and the engine bilges are watertight. A hose equipped with a valve enables water that enters accidentally to run into the sump. Under normal conditions these remain closed.

Waste water from the heads is drained off by a thru-hull fitting with ball valve (the valve is closed when the valve handle is perpendicular to the hose, the valve is open when the valve handle is in line with the hose).

• MAINTENANCE

- Regularly check the valves and thru-hull fittings for proper operation and watertightness.
- Turn off the valves when the water system is not in use.
- Visually check the water pump flow.
- Check the clamps and flexible hose connections for tightness. Pay attention to the seals for condition.
- Regularly make sure that the sump and bilge are perfectly clean.

RECOMMENDATION

Immediately switch off the electric system in case a pump is running while all the water supplies are turned off.

- In case of a leak check the system.

WARNING

The bilge pump system is not designed to provide buoyancy to the boat in case of damage.

The bilge pump system is designed to drive out the water being either sea spray or leaks but absolutely not the water coming through a hole in the hull, this hole being the result of a damage.

SCHEMATIC DIAGRAM DRAINAGE SYSTEM

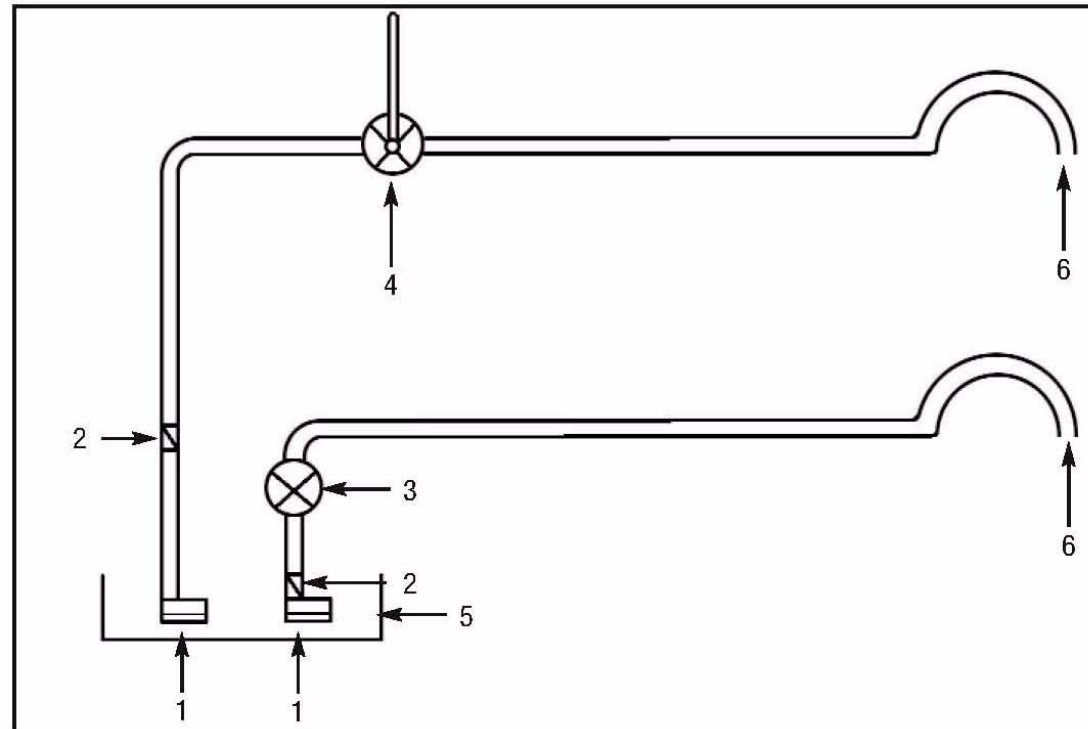

- 1. Stuffing box.
- 2. Non-return valve.
- 3. Electric bilge pumps with automatic start mechanism.

- 4. Manual bilge pump - Cockpit.
- 5. Sump.
- 6. Drainage outlet.

PLUMBING

■ Sanitary equipment

- USE OF THE WASHBASINS AND SHOWERS

The waste waters from the washroom are drained by pumps located under the basins.

Activate the on switch located in front of the basin.

Clean filters and trays regularly.

RECOMMENDATION

When you are in a marina, use the club-house sanitary facilities (if there are).

Since it is prohibited to discharge the waste waters in some marinas or countries, you shall use a waste holding tank (WHT).

- USE OF THE MARINE HEADS

Before you use the heads, check that the water intake valve and draining valve are open.

To empty the bowl:

- Set the control lever of the pump slantwise (FLUSH).
- Operate the pump.

To dry the bowl:

- Set the lever back vertical (DRY).
- Operate the pump.

7

PLUMBING

65

SEWAGE TANK

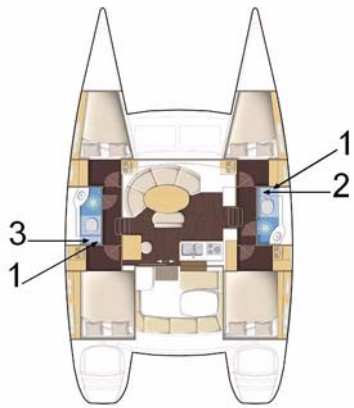

Sewage tank
(Landmark 2/3)
Capacity: 83 liter



Valve - Drainage to sea
(Landmark 1)



Seawater inlet WC
(Landmark 6)



CIRCUIT BLACK WATER TANKS

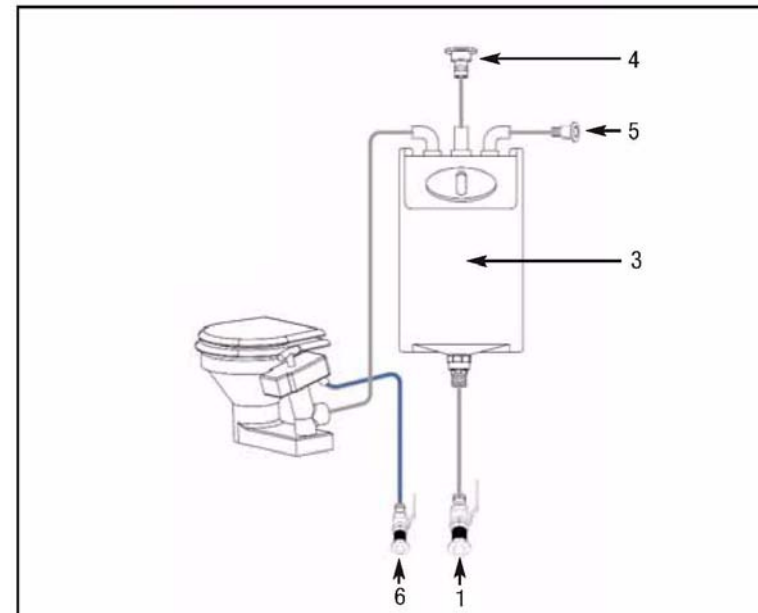

- 1. Valve - Drainage to sea
- 2. Sewage tank
To starboard (optional)
- 3. Sewage tank
To port
- 4. Deck drainage
- 5. Vent hole
- 6. Seawater inlet WC

PLUMBING

The port aft toilets are fitted with a soil water tank. The starboard hull toilets can be fitted with one as an optional extra, optional extra.

Before use ensure that the drain valve on the bowl is closed in order to avoid any inadvertent discharge (valve is closed when the valve handle is perpendicular with the pipe).

To empty the tank:

- In an authorized area, open the draining valve.
- In a marina equipped with a system to suck the waste waters, put the sucking hose into the tank through the deck filler, then start the suction.

WARNING

Ask for information about the laws in force in your country or your marina about discharging your waste waters into the sea.

The filler caps are opened and closed with an appropriate key. When the tank is empty, check the cap seal for condition then close the filler.

To rinse out the system: Fill the tank with fresh or sea water, then empty. Only use domestic cleaning products.

The tanks must be empty when the boat is moored in negative temperatures.

RECOMMENDATION

Use the pump system at ports or marinas to empty the waste holding tanks.

RECOMMENDATION

For the protection of the environment, do not discharge the contents of the waste holding tanks near the shore.

7

PLUMBING

67

Engine

8

FUEL TANKS.....	71
FUEL FILTER.....	73
ENGINES	75
INSTRUMENT PANEL.....	77
PROPELLERS AND ANODES	77

IMPLANTATION MOTORIZATION

ENGINE

70

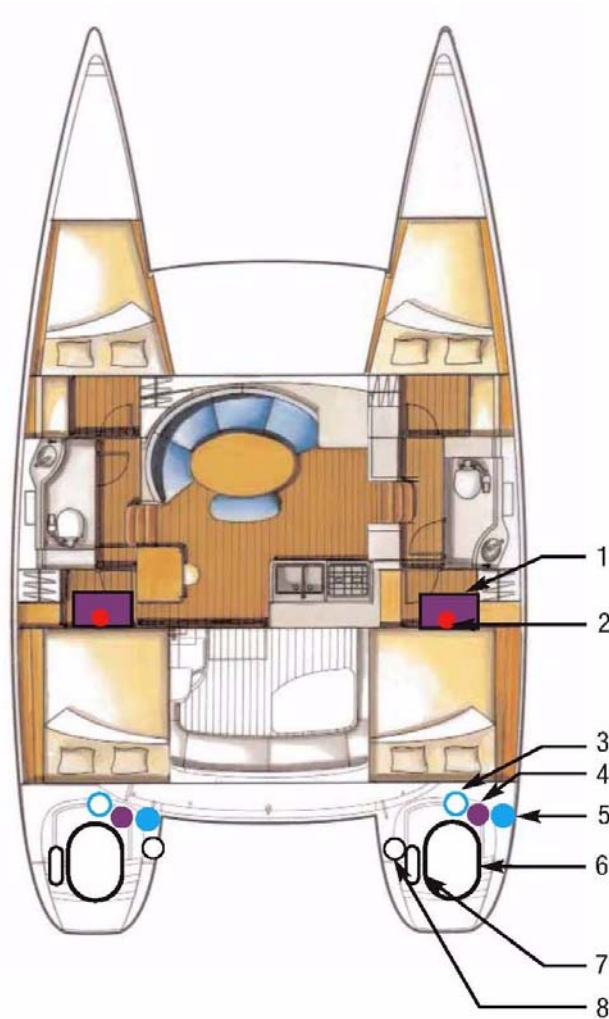

1. Fuel tank.
2. Fuel shut-off valve.
3. Accumulator tank.
4. Fuel filter.
5. Sea water filter.
6. Engine.
7. Silencer.
8. Deck filler.

ENGINE

■ Fuel tanks

The boat is fitted with 2 tanks (1 in each hull). They are both filled independently. They both have a fuel gauge on the engine panel.

- FILLING

Take the general precautions stated in chapter 7 about the water tank filling.

Fill the tanks using the 2 fuel fillers.

In order to protect the deck from possible fuel splash, wet the area around the filler with sea water before you remove the filler cap.

In case of splashes, rinse the deck thoroughly (after fitting back the filler cap).

DANGER

Stop the engine and refrain from smoking during fuel tank filling.

- MAINTENANCE

- Regularly check the O ring of the filler for good condition (in order to prevent water entries).
- Do not turn off the fuel tap after each use (except in case the boat is unattended for long).
- Keep the fuel tank as full as possible (to avoid condensation).

- Every 5 years clean the tank to remove possible sludge deposition.
- Every year check the fuel system for condition (hose, valves, etc.).

NOTE: The capacity of the fuel tank or tanks indicated in the page "Specifications" cannot be completely used according to the trim and load of the boat.

Always keep 20 % fuel as a reserve.

RECOMMENDATION

Have a professional to carry out the works on the damaged parts of the fuel system.



ENGINE

71

ENGINE INSTALLATION (COMPARTMENT STARBOARD)

ENGINE

72

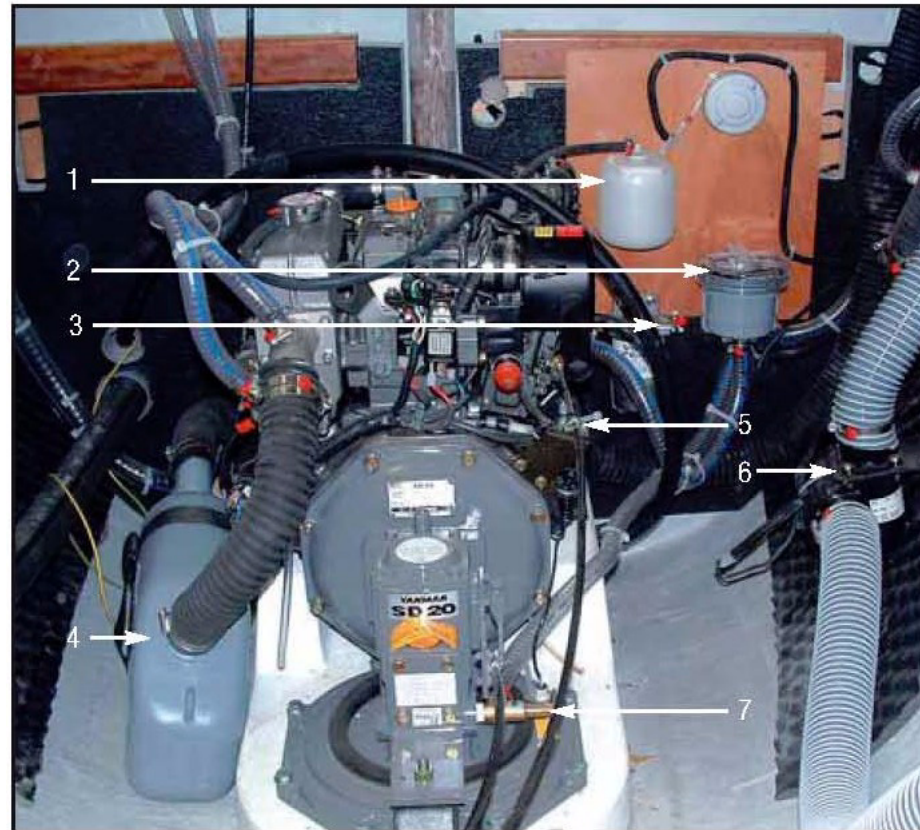

1. Accumulator tank.
2. Sea water filter.
3. Fuel filter.

4. Silencer.
5. Engine.
6. Engine compartment ventilator.
7. Engine water valve.

ENGINE

■ Fuel filter

The engine running problems may have different origins, among which dirty fuel.

The injection pump may wear out if there is water in the system.

The water results either from the condensation resulting from an insufficiently filled tank, or from a filler cap either not closed properly or with a damaged seal.

In order to prevent any water infiltration, the fuel runs through two filters:

- The first filter is on the pipe that joins the tank to the engine, it has the functions of a water decanter and pre-filter.
- A second filter is an integral part of the engine its role is to filter fuel very finely.
To know when you have to intervene and how frequently you have to change it, please refer to the engine's manual.

Drain by undoing the knurled screw at the base of the decantation bowl (but not removing it).

Allow to flow into a box till the fuel looks clean.

Do it several times a year.

Change the pre-filter at least once a year (access to it when you remove the bowl).



ENGINE WATER VALVE

ENGINE

74



ENGINE WATER VALVE



STUFFING BOX

ENGINE

■ Engines

RECOMMENDATION

Carefully read the instructions given with your boat.

WARNING

Never run the engine when the boat is hauled out:

- ACCESS TO THE ENGINE

The engine access is through the rear apron.

RECOMMENDATION

Stop the engine before opening the hatches.

In case of an intervention when the engine is running:

- Stay away from belts and mobile parts.
- Be careful with full clothes, long hair, rings etc. (you may be caught).
- Wear appropriate clothes (gloves, caps etc.).

- ENGINE WATER VALVE

The water inlet valves are essential for the operation of the engine. These valves must be open before the engine is started (risk of rapid deterioration of the exhaust pipe and of major damage to the engine).

- Keep the strainer under the hull as clean as possible.
- Brush the strainer when the boat is careened.
- Do not cover the strainer with antifouling paint.

ADVICE: Get used to checking immediately after starting the engine if water is expelled with the exhaust gases.

If water does not flow out:

- Stop the engine immediately.
- Check that the valve is open.

Close the water inlet valve if the boat is unattended for long. Inspect and clean the water filter regularly.



ENGINE

75

FUEL VALVE - ANODES

ENGINE

76



FUEL VALVE



ANODE
(on the housing)



ANODE
(On hull, under water line)

ENGINE

- FUEL

Refill before the fuel tanks have almost run dry (the fuel system may be stopped for lack of fuel).

Make sure you have enough fuel before sailing.

- MAINTENANCE

Refer to the manufacturer's manual given with your boat.

Be careful with any possible risk of oil and fuel spillage.

Check the exhaust gas colour. In the case of excessive white or black smoke, consult an engine specialist.

■ Instrument panel

The instrument panel has all the testing functions of the engine and it does not require any special precaution (refer to engine leaflet).

■ Propellers and anodes

The propellers fitted as standard to your boat result from trials carried out in collaboration with the engine manufacturer.

RECOMMENDATION

Do not change the propeller without specialist's advice.

Remove the foldaway propellers (optional extra) at the end of each season, dismantle them and clean them carefully.

Grease the thrust bearing surfaces and teeth. Check that the propeller blades move easily.

If necessary, install new anodes (on hulls and base plates).

Replace anodes before they are 50% corroded.

RECOMMENDATION

Ensure that the base plate anodes have good metal contact with the transmissions.

Never paint the anodes.

Assemble the propellers before re-launching the boat.



ENGINE

77

Rigging & Sails

9

STANDING RIGGING	83
RUNNING RIGGING	87
WINCHES.....	87
SAIL SETTING.....	89
SAILS.....	91

STANDING RIGGING

RIGGING
& SAILS

80

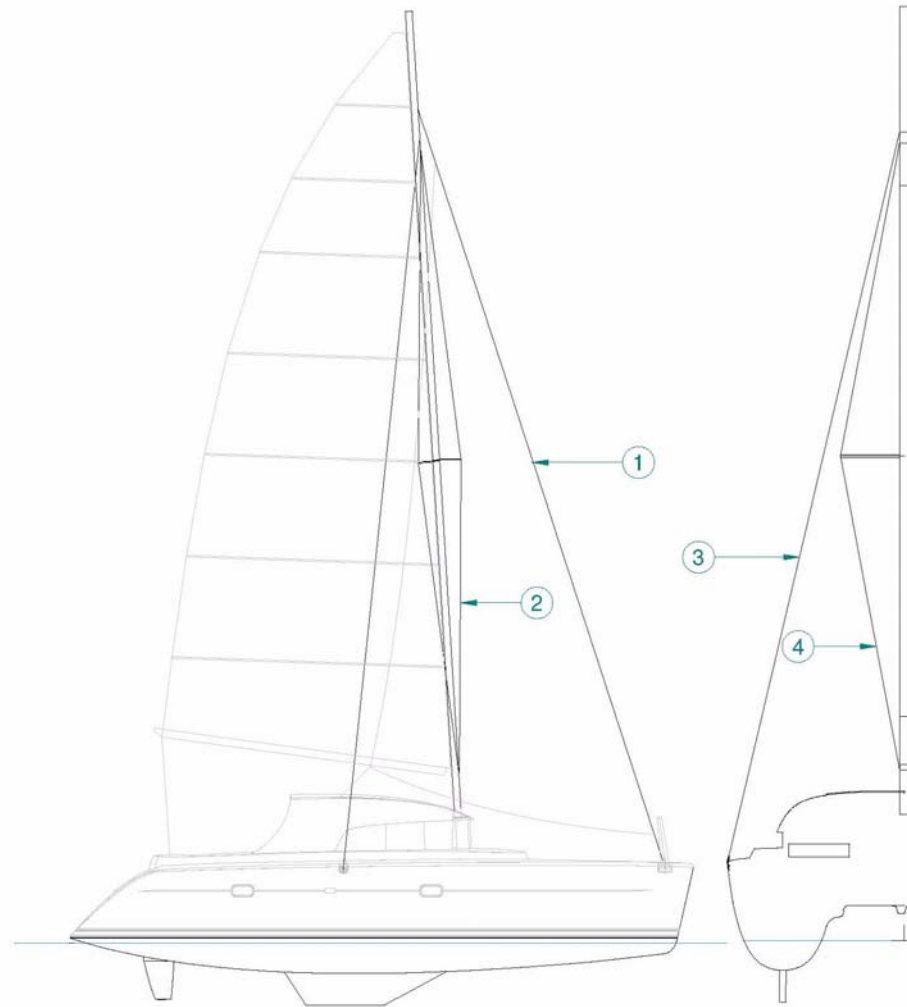

RIGGING & SAILS

SHORT MAST

Reference	Rigging	Length (mm)	Diameter (mm)
1	Forestay	14 113	12
2	Martingale	9 876	10
3	Upper shroud	13 458	12
4	Diamonds	11 226	10

9

RIGGING
& SAILS

81

■ Standing rigging

- CABLE ADJUSTMENT

Your mast will have been pre-set both by the boatyard and by the mast manufacturer during the first mast stepping.

However, after a few sea trips, the mast should be reset once the cables have "given" to their full length. proceed as follows:

- Slacken the lower shrouds.
- Tighten the topping lift or use the mainsail halyard in its place.
- Loosen the lazy-jacks.
- Take up the upper and lower diamonds, evenly in order to obtain a straight profile. The mast should now curve evenly towards aft.
- The forestay is pre-adjusted to have an angle of 2,6° to aft.
- ension the backstays by tightening the turnbuckles with a wrench and a 30 cm pipe (check that the mast head is centered).
- Take the tension back up in the lower shrouds by turning the turnbuckles by hand.
- Take the lazy-jacks back up.
- The mast should remain curved towards aft.

Under sail with a 20 knot apparent cross wind, it is normal for the leeward rigging to be slightly slack; if necessary, thread a shock cord between the backstay and the lower shroud leeward to stop any flapping .

- MAINTENANCE

Before each trip, carefully inspect the mast from top to bottom. Periodically check the rigging tightening and the lock nut or pin locking (you should check it for the first time after a few days sailing in all types of weather).

Secure and lubricate the bottle screws with tallow, graphite grease or other (Never lubricate the bottle screws with silicone).

Check the bottle screw tightening.

Inspect the bottle screws for possible wear (due to the chainplate friction if the rigging is slack).

Change any shroud or stay with severed wires or kinks.

Regularly check the chain-plates for wear.

DANGER

To hoist a crew member up to the top of the mast, make a bowline with the halyard directly on the bosun's chair ring (never use the halyard snap shackle or shackle). Do not hoist a crew member when sailing in heavy weather.

ADVICE: Your LAGOON dealer can carry out all the maintenance operations.

RIGGING DIAGRAM

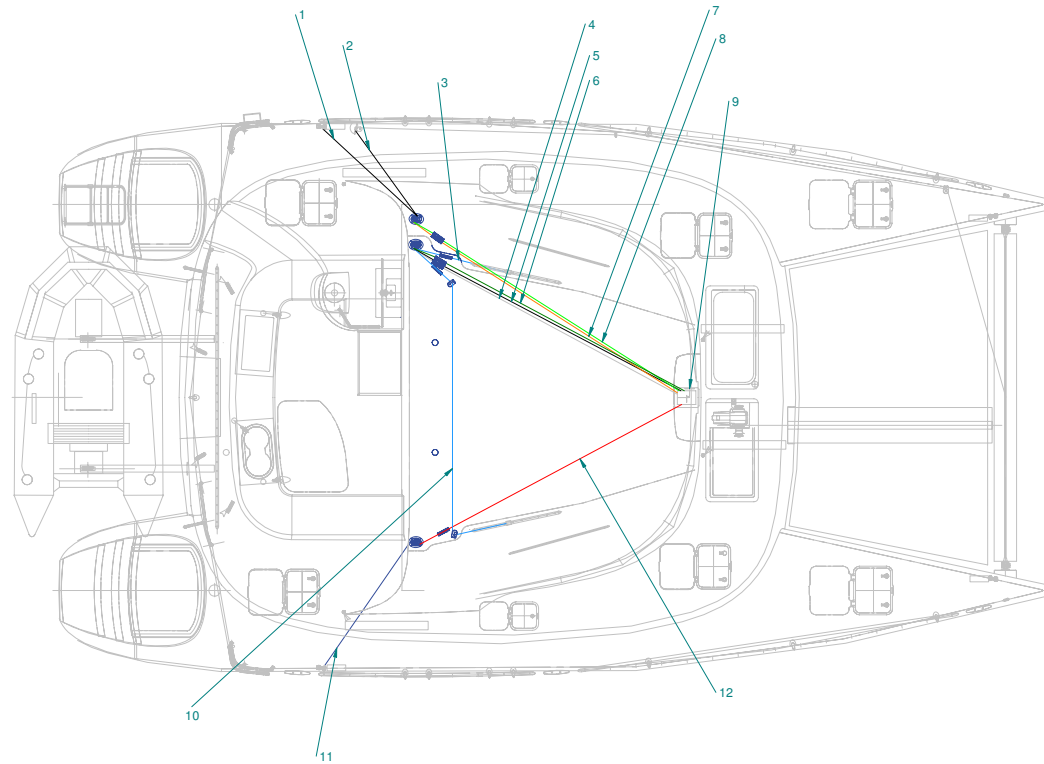

RIGGING
& SAILS

84

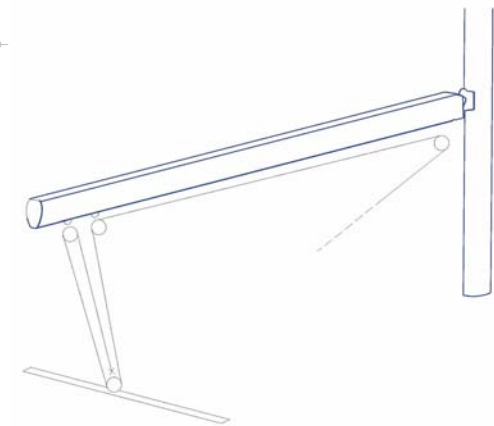

DETAIL TACKLE OF BIG VEIL

RIGGING & SAILS

CLASSICAL MAST

Reference	Designation	Length (mm)	Diameter (mm)
1	Spinnaker sheet / Gennaker (optional)	18 / 24	12
2	Genoa furler line	12	8
3	Genoa sheet - To port	13	12
4	Main sheet	54	14
5	Main halyard (With pulley block)	50	14
6	Kicking strap		
7	Reef 1		
8	Reef 2		
9	Genoa halyard	31	12
10	Genoa sheet - To starboard	13	12
11	Spinnaker sheet / Gennaker (optional)	18 / 24	12
12	Spinnaker halyard / Gennaker (optional)	39	14
	Uphaul - Mainsail (classic)	39	12
	Mainsail traveller pass rope	16	8

RUNNING RIGGING

IN-MAST ROLLER FURLER

Reference	Designation	Length (mm)	Diameter (mm)
1	Spinnaker sheet / Gennaker (optional)	18 / 24	12
2	Genoa furler line	12	8
3	Genoa sheet - To port	13	12
4	Main sheet	54	14
5	Mainsail safety block stopper	50	14
6	Mainsail foot		
7	Main halyard		
8	Kicking strap		
9	Genoa halyard	31	12
10	Genoa sheet - To starboard	13	12
11	Spinnaker sheet / Gennaker (optional)	18 / 24	12
12	Spinnaker halyard / Gennaker (optional)	39	14
	Uphaul - Mainsail (classic)	39	12
	Mainsail traveller pass rope	16	8

■ Running rigging

Lubricate the sheaves with silicone. Change any distorted or dented sheave. Inspect the pins of the sheaves at the top of the mast once a year.

Regularly check the jam cleat jaws for condition.

Inspect the halyards for wear and condition.

Regularly clean the blocks (waste grease, corrosion spot).

Slightly lubricate the block pins.

Avoid untimely gybes in order to reduce the premature wear on the sheets and attachment points.

■ Winches

Avoid rope jamming during winch handling.

Do not leave loose ropes on the winches but fasten them on cleats.

Adjust the winches on receipt of your boat (rinse them regularly during the season).

The winches should rotate freely, they need overhaul as soon as it slightly seizes.

- MAINTENANCE

Carry out the complete maintenance of the winches regularly (before and during the sailing season).

- Remove the drums and clean them.

- Lubricate the drums with a film of white grease or Teflon to reduce the friction and fight against corrosion (this type of grease is clean, non toxic and biodegradable).

WARNING

Refer to the manufacturer's instructions to remove the winches and put them back.

Improper refitting may result in accidents (e.g. kick of the crank handle).

RECOMMENDATION

A winch drum is designed to have a minimum number of turns necessary so that it does not slip and that the stress is not passed on to the self-tailing mechanism.

Make at least 3 or 4 turns on the winch.

WARNING

Keep hands away electric winches (optional) when used.

Close the doors after use of switches.

GENNAKER



FIXING OF THE GENNAKER HALYARD ONTO THE HEAD



CHAIN SWIVEL TAKE-UP DRUM

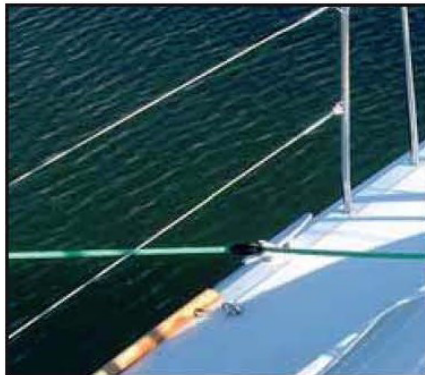

RETURN BLOCK FOR GENNAKER SHEET



PASSAGE OF GENNAKER SHEET

■ Sail setting

- FURLING GENOA

Before getting under way take advantage of a windless period of time and hoist the genoa.

Hand pre-roll the drum to set the furling line on it.

Pay attention to the drum winding direction: The sacrificial strip of the genoa shall be wrapped outside.

- Secure the head and halyard to the swivel. Secure the tack to the drum and sheets.
- Insert the bolt rope into the hole and hoist it and take care that you do not tear it.
- Have the halyard taut enough but hoist less taut than a sail on a normal stay.

Hoist it until the horizontal creases disappear (Adjust the tension of the luff after a few sea trips).

- Before you furl the genoa, remove the ring that is used to guide the bolt rope. Keep this ring in a safe place and put it back before any handling (lowering etc.).
- Pull on the line from the cockpit to furl the genoa.

Never force it in case it seizes when you furl or unfurl the head sails. Make sure a halyard is not jammed in the furler. Verify that the sail is not too much tarque.

- MAINTENANCE

- Regularly rinse the drum and swivel.
- Lubricate the bearings if recommended by the manufacturer.
- Unrig the sails if your boat is not to be used for long.

- MAINSAIL (CLASSIC)

To hoist the mainsail:

- Head into the wind.
- Slacken the mainsail sheet.
- Hoist the sail taking care that the battens do not catch up on the lazy-jacks.

- GENNAKER (OPTIONAL)

Before getting under way take advantage of a windless period of time and hoist the genoa.

- Fix the chain swivel to the gennaker head.
- Fix the halyard to the head chain swivel.
- Put the take-up drum on to the spar with a snap shackle.
- Fix the halyard to the head chain swivel.
- Hoist the gennaker.

Use the take-up drum stopper to furl or unfurl the gennaker.

- SHEETS

- Fix the sheets to the gennaker clews.
- Thread the sheets around the outside of the stay and of the shrouds and over the jack-lines.
- Fasten the sheet return blocks to the bolts.
- Lead the sheets back to the Genoa sheet winches.

WARNING

De-rig the gennaker when not in use (danger of damage through UV rays and accidental unfurling).

RIGGING
& SAILS

90

LAGOON 380

■ Sails

How long a sail lasts mainly depends on its regular maintenance. Piece of advice: At the end of the sailing season, and if possible before winter, leave your sails to a specialist to have efficient maintenance and repairs.

When sailing, trim the sails properly in accordance with the stresses in order to reduce the harmful strains on the fabric.

Avoid tears and wear: Use protective items against chafing on the the accessories with rough surfaces (protective items for spreaders, stanchions etc.).

Between two sea trips, slacken the halyard (for the sails on furler) and the mainsail foot tuning line.

Have a sail maker's kit and a user's manual so that you may carry out the emergency repairs waiting for the sailmaker's assistance.

- CLEANING AND MAINTENANCE

Rinse the sails with fresh water from time to time and dry quickly in order to avoid mildew.

Avoid drying the sails to windward when on the mast (when the sails lift, the seams are worn, the sails may be torn by the rigging).

To remove grease stains: Use trichlorethylene then immediately rinse with water.

- SAIL STORAGE/FOLDING

Avoid storing a wet sail to prevent mildew from appearing. Accordion fold the sail parallel to the foot, then roll it up to the bag dimensions.

- PROTECTION

UV rays are harmful to polyester and nylon. If the sails remain on the mast, even for *1 h, protect them with a cover or a protection fabric placed on the leech and foot of the furled sails.

Our agents' network offers you accessories that have been selected by the yard and are consistent with your needs.

SAFETY EQUIPMENT	95
GAS SYSTEM SAFETY INSTRUCTIONS	97
FIGHT AGAINST FIRE.....	99
ASSÈCHEMENT	101
EMERGENCY TILLER	101
CAPSIZING	103
ENGINE	103
GENERAL POINTS.....	103

POSITION OF THE LIFERAFT

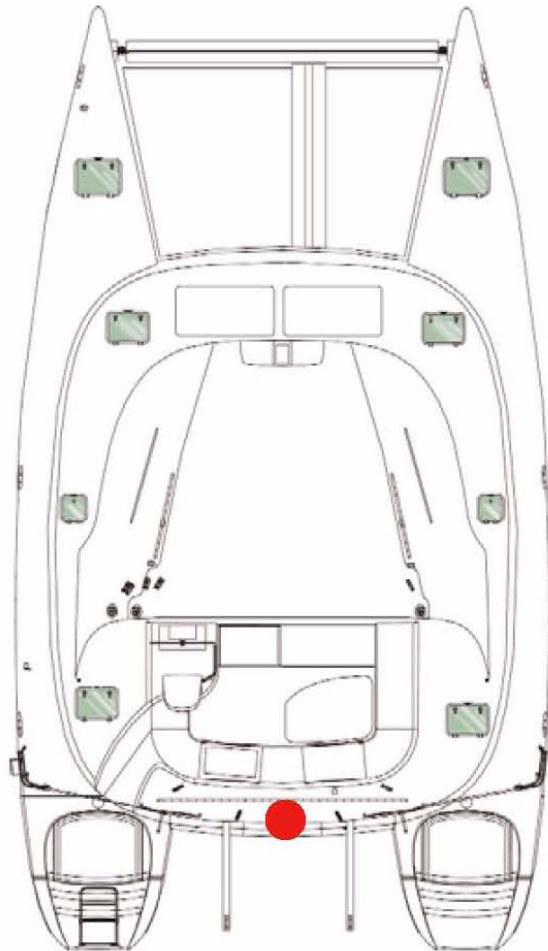

DIMENSIONS OF LIFE-RAFT LOCKER IN MM

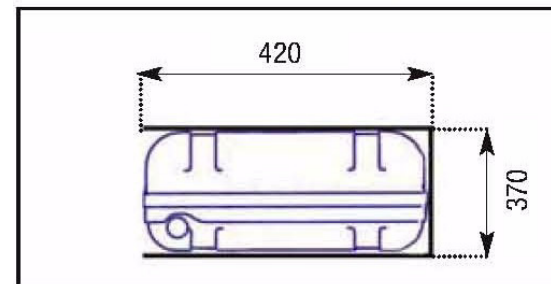
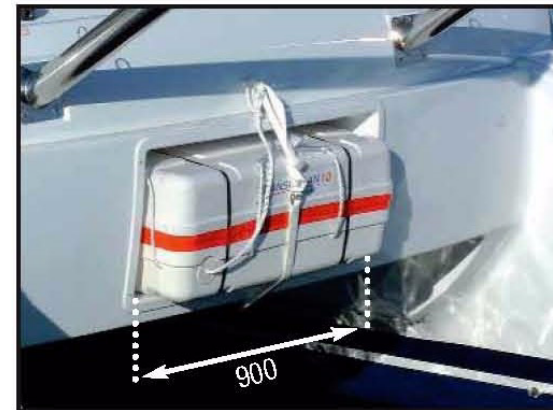

SAFETY

94

SAFETY

■ Safety Equipment

WARNING

The inventory of safety equipment required is a class certification.

- Before you sail, list the compulsory safety equipment.
- Attach jack-lines to the deck and underneath the nacelle body (close to the manholes).
- Don't exceed the number of persons indicated in the chapter 'Specifications'.
- When you don't take into account the number of persons, the total weight of the persons and equipment shall never exceed the maximum load recommended by the manufacturer.

RECOMMENDATION

Close the deck hatches and fore portholes each time before each trip.

- LIFERAFT

The life raft was located in the rear beam.

At the bottom of the raft locker is a hammer.
In the case of capsizing break the glass of the "manhole" cover using the hammer if necessary.

RECOMMENDATION

Before you sail to sea, carefully read the instructions indicated on the liferaft to launch it.

10

SAFETY

95

GAS VALVES

SAFETY

96



GAS VALVES

(cupboard under the oven)

SAFETY

■ Gas system safety instructions

The gas bottles are located in the starboard locker of the aft cockpit. The type of bottle (butane) is according to the current standards in your country.

Close the valves on the system and on the cylinder when the appliances are not used.

Close the valves before you change cylinders and immediately in case of emergency.

Never leave unattended an appliance that is working.

Don't install or store flammable materials above or over the stove (curtains, papers, napkins etc.).

Don't use the oven or stove as back up heaters.

Never obstruct the fast access to the components of the gas system.

Make sure that the valves of the appliances are closed before you open the cylinder or hose valve.

In case you smell gas or find that the burners have gone out (although appliance models cut off automatically if the flames go out), turn off the valves of the appliances. Do ventilate the boat in order to get rid of any residual gas. Find the cause of the problem. Regularly test the gas system in order to detect any gas leak.

Check all the connections using water and soap or detergent, closing the valves of the appliances and opening the valve on the cylinder.

If you detect a leak, close the valve of the cylinder and repair before you use it again.

WARNING

- Don't use a solution containing ammonia.
- Don't use a flame to detect leaks.
- Don't smoke, don't use a naked flame when you change the gas cylinder.

The appliances use the oxygen of the cabin and release combustible gases. Ventilate your boat when using appliances.

Don't obstruct the air vents and at least leave the door open.

Lock the stove oven when being not used in order to avoid damaging the tubes when sailing.

Keep the taps of the empty cylinders turned off and the cylinders disconnected.

Keep the protection, lids, covers and taps in their places.

Store the empty and spare cylinders on the deck or in a locker with a ventilation to the open air.

Don't use the gas cylinder storage place to store other equipment. Only use the proper locker to store the gas cylinders.

Regularly check and replace the rubber tubings that link the cylinder to one end of the circuit and the stove to the other one, depending on the norms and regulations in force in your country.

Pay particular attention to keep in good condition the screw thread of the cylinder on which the regulator is. Check the condition of the regulator every year and change it if necessary. Use regulators identical to the ones that are fitted.

Have the repairs carried out by someone skilled.

10

SAFETY

97

PLACE OF EMERGENCY EXITS AND PORTABLE FIRE EXTINGUISHERS (not supplied)

- Other locations are possible, the extinguishers shall be less than 5 m from all the berths.
- An extinguisher shall be compulsorily set less than 2 m away from the extinguisher aperture.
- An extinguisher or a fire blanket (ISO ISO 1869) shall be set less than 2 m from any flame appliance.
- An extinguisher shall be less than 1 m from the steering station.
- All extinguishers should be easily accessible and should be able to be reached rapidly for use, maintenance or repair without having to use tools or to remove any part of the boat including drawers and shelves.

SAFETY

98

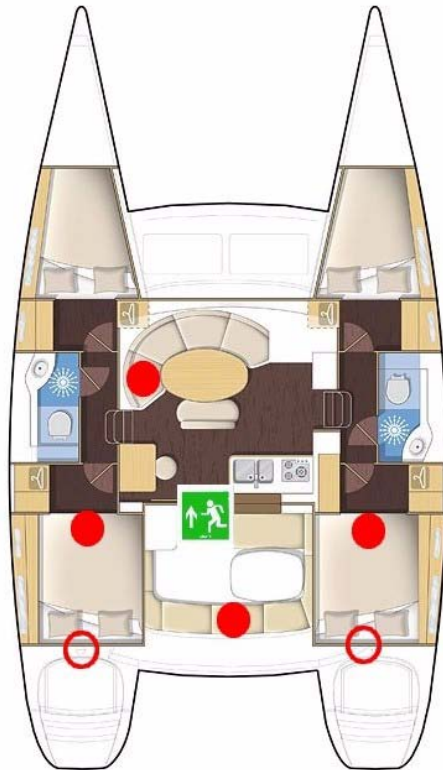

- Portable fire extinguishers (not supplied)
- Emergency exit
- Extinguisher aperture of the engine compartment

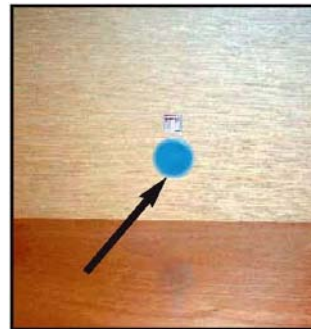

EXTINGUISHER ACCESS HOLE

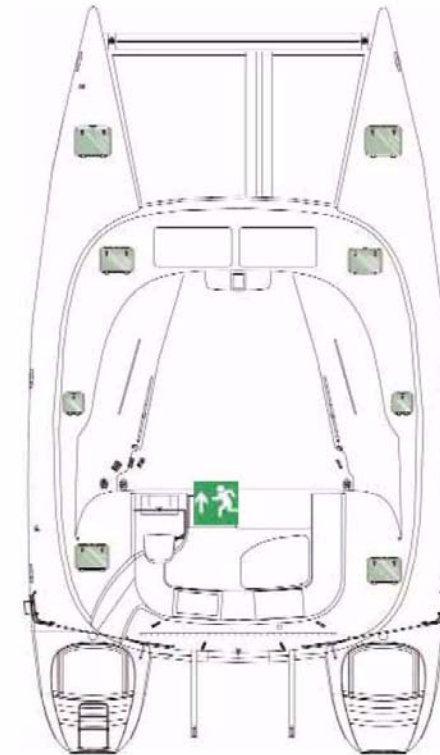

The positions are the same for the other layout version.

SAFETY

■ Fight against fire

WARNING

The boat is delivered without extinguishers ; you are responsible for applying your country's fire safety laws (number of extinguishers, capacity, type and location).

The extinguishers must be within easy access and kept away from a possible fire source.

The engine compartment has an aperture that makes it possible to inject the extinguishing product inside without opening the usual access hatches.

Instructions to follow in case of a fire in the engine compartment bilge:

- Stop the engine.
- Switch off power and stop fuel supply.
- First remove the cap then project the extinguishing substance through the extinction hole situated on the partition of the aft cabin.
- Wait one minute before approaching.
- Open the access hatches and repair.

WARNING

Keep an extinguisher handy in case the fire should start again.

It is the owner's or the skipper's responsibility:

- To have the extinguishers checked in pursuance of the instructions given.
- Use extinguisher replacements with equivalent features (same capacity and fire resistance) if the ones in place are out of date or have been used.
- Make sure the extinguishers can be reached easily when people are on board.

And also inform the crew of:

- where the extinguishers are and how they work.
- where the release aperture is situated in the engine compartment.
- where the emergency exits are.

WARNING

Never:

- Obstruct the ways to the emergency exits.
- Obstruct the safety controls (fuel oil valves, gas valves, power switches).
- Block the extinguishers placed in shelves.
- Leave the boat unattended when a stove or heater is working.
- Use gas lamps in the boat.
- Alter the boat systems (electricity, gas or fuel oil).
- Fill up a tank or change a gas cylinder when an engine is running, a stove or heater is on.
- Smoke while handling fuels or gas.

10

SAFETY

99

FUEL VALVE - EMERGENCY TILLER

SAFETY

100

FUEL SUPPLY VALVE
LAY OUT OF



ACCESS HOLE TO RUDDER STOCK



SAFETY

Keep the bilge clean. Regularly check whether there is fuel oil or gas vapour.

Use only compatible spare parts for the extinguishers. The parts shall have the same specifications or be technically equivalent as to their resistance to fire.

Always fasten the curtains with their snap fasteners when the gas cooker is working.

Combustible products shall not be stored in the engine compartment. If you store non combustible products in the engine compartment, they shall be fastened so that they cannot fall on the machine and block the way.

WARNING

The CO2 extinguishers shall be used only to fight electrical fires.

Clear the area immediately after use in order to avoid suffocation.

Air before entering.

■ Assèchement

• ELECTRIC BILGE PUMPS

The wells are equipped with two automatic start electric bilge pumps.

Lay out of: Washroom

Capacity: 2 x 15 liter / minute.

• MANUALS BILGE PUMPS

The manual bilge pumps are located along the sides of the aft cockpit bench.

Capacity: 2 x 31,5 liter / minute.

■ Emergency tiller

The liferaft should be placed in a cockpit locker. It must be easily accessible.

To operate the tiller:

- Use a winch handle to unscrew one of the emergency tiller deck plates located on the first step of the rear transom.
- Insert the emergency tiller in the rudder stock and make sure it is fully engaged.

Regularly check tension of the turnbuckles on the turnbuckles steering cables.

RECOMMENDATION

The emergency tiller is designed only to sail at a reduced speed in case of a wheel failure.

10

SAFETY

101

ESCAPE "HATCHES"

SAFETY

102



SAFETY

■ Capsizing

Panels "exits" are provided in the rear cabin.
The security bar (anti-theft device) automatically detaches if the boat capsizes.

The life-rafts are accessible on the transom (see the beginning of the chapter).

■ Engine

- Never start the engine when the boat is out of the water.
- Never turn the propellers when the boat is out of the water.
- Be careful not to cut yourself on the sharp edges of the propellers.
- Be careful not to injure yourself when opening or closing the blades.

- Stop the engine before diving or swimming around the boat.
- The propeller blades are sharp and can cause major damage when rotating.
- Never attempt to release a fishing net or line caught in the propeller when it is rotating.

- Before setting sail, check that the propellers are working in both fore and aft positions.
- In the event of unusual noises or vibrations emanating from the propellers, stop the engines immediately.

If the problem persists, contact the builder or your nearest supplier.

If you are using a propeller with fold-away blades, read the manufacturer's use and maintenance instructions carefully.

■ General points

- Locate and prevent the team before any maneuver on the boat.
- Always proceed with care, using gloves and always wearing shoes.

10

SAFETY

103

General specifications- 11

DESIGN CATEGORY	106
GENERAL SPECIFICATIONS.....	107

DESIGN CATEGORY

■ Category A

This boat is designed for sailing in winds that may exceed force 8 on the Beaufort scale and in waves of a significant height of 4 m and more, and the boat is to a large extent self-sufficient. Unusual conditions such as hurricanes are excluded.

You may meet with such conditions when you sail long crossings, for instance across the oceans, or close to the shore, when you are not protected from the wind or waves over several hundreds of nautical miles.

■ Category B

This boat is designed for sailing in winds that may exceed force 8 on the Beaufort scale and in waves of a significant height of 4 m or less.

You may meet with such conditions when you sail on the open sea or close to the shore, when you are not protected from the wind or waves over several hundreds of nautical miles. You may also meet with these conditions on an inland sea with a size sufficient to generate the wave height in question.

■ Category C

This boat is designed for sailing in winds that may exceed force 6 on the Beaufort scale and in waves of a significant height of 2 m or less.

You may meet with such conditions in exposed inland waters, in estuaries and in coastal waters with moderate weather conditions.

■ Category D

This boat is designed for sailing in winds not exceeding force 4 on the Beaufort scale and in waves of a corresponding height (significant height of 0,5 m or less).

You may meet such conditions in protected inland waters and in coastal waters when the weather is fine.

- Note:

The significant height of a wave is the average height of the upper third of the waves, that approximately corresponds to the height of a wave an experienced observer can assess. Some waves will be twice as high as this value.

GENERAL SPECIFICATIONS

■ Boat

L.O.A.....	11,55 m / 37'9"
L.W.L.....	11,00 m / 36'1"
Max. beam	6,53 m / 21'5"
Air draught	17,70 m / 57'0"
Draught	1,15 m / 3'9"
Light displacement	7 130 kg / 15 720 lbs
Displacement with maximum load	10 145 kg / 22 365 lbs
Charge maxim registered.....	3 015 kg / 6 648 lbs
Including the mass of the persons who are authorized on board (75 kg per adult), the supplies, the liquids that can be used (fresh water and fuel) in fixed completely full tanks, the additional loads, the optional equipments, the liferaft and the scope for load.	
Freshwater capacity.....	300 l / 79 US gal
Freshwater capacity - additional	300 l / 79 US gal
Sewage water capacity	85 l (in each bathroom)
Fuel oil tank capacity	2 x 100 l / 2 x 26 US gal
Refrigeration unit capacity	200 l + 185 l / 53 + 49 US gal
Battery capacity - House.....	2 x 140 Ah (12 V)
Battery capacity - Engine	2 x 110 Ah (12 V)
Battery capacity additional	140 A (12 V)
Maximum power Engine	60 kW
Architect.....	VAN PETEGHEM / LAURIOT PREVOST
Interior design	Xavier FAY

CE category	Maximum number of persons
A.....	8
B.....	10
C.....	12
D.....	14

■ Sails

Batten mainsail.....	47 m ² / 506 sq.ft
Furling genoa	30 m ² / 323 sq.ft
Gennaker (optional)	52 m ² / 560 sq.ft
I.....	13,50 m / 43'0"
J.....	3,57 m / 11'7"
P.....	13,65 m / 44'8"
E.....	5,40 m / 17'7"
LP.....	4,63 m / 15'2"

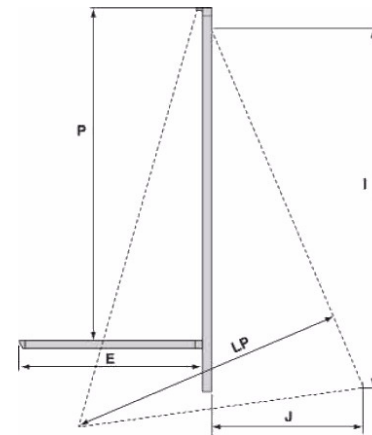

11

GENERAL SPECIFICATIONS

107

YOUR LAGOON 380

NAME OF THE BOAT:

NAME OF THE OWNER:

VERSION:

ADDRESS:

DELIVERY DATE:

.....

REGISTRATION NUMBER:

.....

DOOR KEY NUMBER:

HULL NUMBER:

Telephone N° / Address to be contacted in case of emergency

MAKE OF ENGINE:

ENGINE KEY NUMBER:

ENGINE SERIAL NUMBER TO STARBOARD:

TRANSMISSION SERIAL NUMBER TO STARBOARD:

ENGINE SERIAL NUMBER TO PORT:

TRANSMISSION SERIAL NUMBER TO PORT:



www.cata-lagoon.com

PERSONAL NOTES

.....

.....

.....

.....

.....

.....

.....

.....

.....

.....

.....

.....

.....

.....

.....

.....

.....

Dealer stamp

.....

.....



www.cata-lagoon.com

162, quai de Brazza - 33100 Bordeaux - France • Tél. 33 (0) 557 80 92 80 • Fax 33 (0) 557 80 92 81 • E-mail : info@cata-lagoon.com