

**DUFOUR**  
YACHTS

*Grand'Large*

## OWNER'S MANUAL



**DUFOUR | 375**  
*Grand'Large*

DESIGN CATEGORY OF YACHT A

In accordance with European directive 94/25/CE  
As amended by European directive 2003/44/CE

This page intentionally left blank

\*\*\*

This page intentionally left blank

\*\*\*

This page intentionally left blank

\*\*\*

**Your agent**

Name

is **DUFOUR YACHTS'** representative and will give you all the help you need to solve any difficulties you might have during launching and masting of your boat, as well as for commissioning and maintenance technical checks. If necessary, he will help you with the administrative process of registering your boat.

As soon as you become the owner, familiarize yourself with the manual supplied with your boat, sign and date the receipt acknowledgements below, and give (or send) the last one to your agent.

**Owner's Manual receipt acknowledgement to be kept in your Manual**

I, the undersigned:

Name

Address

owner of **DUFOUR 375** no.

confirm that I have received the Owner's Manual for my **DUFOUR 375** and accept its being written in English.

Dated:

Signature:

Detach along dotted line

**Owner's Manual receipt acknowledgement to be returned to DUFOUR YACHTS**

*1, Rue Blaise Pascal- 17187 PERIGNY CEDEX- FRANCE*

I, the undersigned:

Name

Address

owner of **DUFOUR 375** no.

confirm that I have received the Owner's Manual for my **DUFOUR 375** and accept its being written in English.

Dated:

Signature:

This page intentionally left blank

\*\*\*

This page intentionally left blank

\*\*\*

This page intentionally left blank

\*\*\*

# CONTENTS

<b>INTRODUCTION</b> .....	7
<b>I. GENERAL INFORMATION</b> .....	8
Design category .....	8
Certification .....	8
Identification .....	8
Builder's plate .....	9
Degrees of danger .....	10
<b>II. PRINCIPAL SPECIFICATIONS</b> .....	10
<b>III. ELECTRICAL SYSTEMS</b> .....	11
Safety and operating instructions for the electrical system (ISO 10133) .....	11
Installing new equipment .....	11
Batteries .....	12
Electric windlass .....	12
220 / 110 Volt installation .....	13
<b>IV. GAS INSTALLATION</b> .....	14
Operating advice .....	14
Checking the system .....	15
Changing the gas cylinder .....	15
<b>V. DRAIN &amp; SANITATION SYSTEM</b> .....	16
Specifications of the drain system .....	16
Pressurized fresh-water pump .....	16
Seacocks .....	17
Operation of the sea toilets .....	17
Holding tank operation .....	17
<b>VI. FLOODING</b> .....	18
<b>VII. FIRE PROTECTION</b> .....	18
Installation .....	18
Safety instructions .....	19
<b>VIII. ENGINE</b> .....	20
General precautions .....	20
Exhaust gas emission .....	20
Safety .....	20
Wintering .....	21
<b>IX. FUEL INSTALLATION</b> .....	21
<b>X. STEERING SYSTEM</b> .....	21
Helm .....	21
Emergency tiller .....	22
<b>XI. SAILING</b> .....	22
<b>XII. LIGHTNING PROTECTION</b> .....	23
Maintenance .....	23
Protection of persons during a storm .....	23
<b>XIII. ENVIRONMENTAL PROTECTION &amp; SAFETY</b> .....	23
<b>XIV. SAFETY FACILITIES</b> .....	24
<b>XV. HANDLING, TRANSPORTING, HAULOUT</b> .....	24
<b>XVI. GUARANTEE, TRANSFER OF OWNERSHIP</b> .....	27
<b>DRAWINGS</b> .....	30
1. Presentation plan.....	31
2. Accommodation layout.....	32
3. Deck fittings plan .....	34
4. Sail plan.....	36
5. Halyard and sheet operating diagram .....	38

6.	<i>220 V circuit diagram</i>	40
7.	<i>Charging &amp; power circuit diagram</i>	42
8.	<i>12 V distribution panel diagram</i>	44
9.	<i>12 V electrical panel terminal diagram</i>	46
10.	<i>12V electrical installation diagram</i>	48
11.	<i>220 V electrical installation diagram</i>	50
12.	<i>Steering system diagram</i>	52
13.	<i>Gas system diagram</i>	54
14.	<i>Abandon ship plan</i>	56
15.	<i>Fresh-water system diagram</i>	58
16.	<i>Drain system diagram</i>	60
17.	<i>Skin fitting location diagram</i>	62
18.	<i>Engine installation drawing</i>	64
20.	<i>Lifting diagram</i>	68

# INTRODUCTION

**DUFOUR YACHTS** is pleased to present you with this Manual which will help you get to know your boat better.

This Manual has been produced to help you use your boat safely and enjoyably. It contains details of the boat, the equipment supplied or fitted, its systems and information about their use. Read it carefully and familiarize yourself with the boat before using it.

This Owner's Manual is not a course in sailing safety or seamanship. If this is your first boat, or you are changing to a type of boat you are unfamiliar with, for your convenience and safety, make sure you gain experience handling and using it before taking command. Your agent, your national sailing or cruising federation or your yacht club will be happy to give you information about sailing schools or qualified instructors in your area.

Ensure that forecast wind and sea conditions correspond to the design category of your boat, and that you and your crew are capable of handling the boat in these conditions. Even when your boat is suitable for them, the sea and wind conditions corresponding to design categories A, B, and C vary from severe storm for category A to severe conditions for the top end of category C, subject to dangers of abnormal gusts or waves; these are dangerous conditions in which only an experienced, trained crew in good condition, sailing a properly-maintained boat, can sail in a satisfactory manner.

This Owner's Manual is not a detailed maintenance or repair guide. In the event of problems, consult the boatbuilder or their representative. If a maintenance manual is provided, be sure to use it.

Always employ the services of an experienced professional for maintenance, fitting accessories, or modifications. Modifications that could affect the characteristics of the boat must be assessed, performed and documented by qualified personnel. The boatbuilder cannot be held responsible for modifications made without their approval.

In certain countries, a skipper's license or authorization are required, or special regulations are in force.

Always maintain your boat correctly and make allowance for deterioration due to age or resulting, where applicable, from heavy or unsuitable use. Any boat, however sturdy it is, can be severely damaged if it is used incorrectly. This is incompatible with safe sailing. Always suit your speed and heading to the prevailing sea conditions.

If your boat is equipped with a life-raft, read its instruction manual carefully. The crew must have on board all the safety equipment (life-jackets, harnesses, etc.) corresponding to the type of boat, weather conditions, etc. In some countries, this equipment is mandatory. The crew must be familiarized with the use of all the safety equipment and with emergency safety procedures (man overboard recovery, towing, etc.); training sessions are regularly organized by sailing schools and clubs.

It is recommended that all persons wear appropriate buoyancy aids (life-jackets, personal flotation devices) when on deck. It should be noted that in certain countries, it is compulsory to wear a buoyancy aid (complying with national regulations) at all times.

**KEEP THIS MANUAL IN A SAFE PLACE AND PASS IT ON TO THE NEW OWNER IF YOU SELL THE BOAT.**

***WARNING: Our boats are regularly improved in the light of our customers' experiences and researched by the shipyard, and so the specifications given in this Owner's Manual are not contractually binding and may be changed without notice and without any obligation to update. This manual is intended to cover as much information as possible, so certain equipment or paragraphs might not apply to your boat. In case of doubt, please refer to the inventory which should have been given to you by your agent when you placed your order.***

# I. GENERAL INFORMATION

## ***Design category***

Your **DUFOUR 375** comes under the OCEAN-GOING design category A.

Under conditions of normal use, your boat is designed to sail in waves with a significant height exceeding 4 m and winds of force 8 or above on the Beaufort scale, and to withstand the severest conditions.

This sailing capability is equally dependent on the skills of the crew, their physical capacities, the maintenance of the boat and its equipment.

**So always take care before putting to sea.**

**DUFOUR YACHTS** is not able to guarantee perfect functioning of the boat in exceptional sea conditions (violent storms, hurricanes, cyclones, waterspouts, etc.)

## **DESIGN CATEGORIES**

<b>Design category</b>	<b>Type of sailing</b>	<b>Wind strength (Beaufort)</b>	<b>Wind speed</b>	<b>Effective wave height to be taken into account</b>
A	Ocean-going	Superior to 8	Up to 28 m/s	Higher than 4 m
B	Open sea	Up to and including 8	Up to 21m/s	Up to and including 4 m
C	Inshore	Up to and including 6	Up to 17 m/s	Up to and including 2 m
D	Sheltered waters	Up to and including 4	Up to 13 m/s	Up to and including 0.5 m

Check weather information before putting to sea: **Take to the sea, don't take risks !**

In port: every day, the Harbor Master's Office posts weather bulletins and forecasts over the next few days.

Météo France on 0836 68 08 08

Navifax - direct on 0836 70 18 52

VHF: CROSS transmit several bulletins per day, preceded by an announcement on Channel 16.

## ***Certification***

**DUFOUR YACHTS** has chosen the Institut pour la Certification et la Normalisation dans le Nautisme as the notified body for verifying that your boat complies with European directive CE 94/25, as per module A bis (type approval).

## ***Identification***

The hull identification number is located on starboard side of transom. It contains a series of letters and numbers that begin with FR-DUF...



## Builder's plate

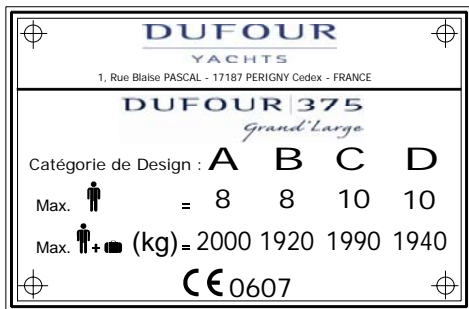

Part of this information is given on the builder's plate attached in the cockpit. A full explanation of this information is given in the chapter that follows.

Design category = A

: Ocean-going (see 1.1)

Max. number of people = 8

: Recommended by the builder for navigation in sea conditions for category for which it was built.



### WARNING

Do not exceed the maximum recommended number of people. However many people there are aboard, the total weight of the people and equipment must never exceed the maximum recommended loading.

Max. additional load = 2,000 kg

: including the maximum number of people with their equipment, belongings, and supplies. (not including various tank capacities (water, fuel, etc.) and the loading that may arise from fitting the various boatyard options.



### WARNING

When loading the boat, never exceed the recommended maximum load. Always load the boat carefully and distribute the weight in a suitable manner in order to maintain the theoretical trim (approximately horizontal). Avoid placing heavy loads high up.

CE 0607

CE mark indicating that the boat complies with all the requirements of the Directive. : The sequence of numbers is the Certification institution's code. In this case, ICNN (Institut pour la Certification et la Normalisation dans le Nautisme), (refer also to: Safety Compliance Declaration)

## Degrees of danger

<b>DANGER</b>	Indicates an extreme intrinsic risk that presents a high probability of death or permanent injury if proper precautions are not taken.
<b>WARNING</b>	Indicates a risk that presents a high probability of death or permanent injury if proper precautions are not taken.
<b>NOTE</b>	Indicates a reminder about safety-related practices, or points out dangerous practices that could result in personal injury or damage to the boat or its components.

## II. PRINCIPAL SPECIFICATIONS

Model:	<b>DUFOUR 375 Grand Large</b>
Designer:	Umberto Felci
Interior design	Felci Yacht Design
Boatbuilder	Dufour Yachts
Design category	A
Notified body no.	CE/0607
Engine #	
Overall length:	11.19 m
Hull length:	10.90 m
LWL:	9.89 m
Maximum beam:	3.85 m
Draught:	
- short keel	1.60 m
- long keel	1.90 m
Mast clearance (under lightly loaded conditions):	
Ballast weight:	
- short	1,950 kg
- long	1,850 kg
Light displacement:	
- short keel	7,160 kg
- long keel	7,060 kg
Displacement at maximum loading:	9,160 kg

Standard mainsail area (approximate)	32.00 m <sup>2</sup>
Genoa area (140%) (approximate)	35.00 m <sup>2</sup>

Water capacity excl. 20L (appx.) water heater	160 L + 200 L = 360 L
Diesel capacity (approximate)	200 L
Holding tank	50 L
Engine battery	1 x 75 Ah
Auxiliary battery:	1 x 100 Ah + 1 x 100 Ah (option)
Primary means of propulsion	Sail
Maximum permissible on-board engine power	1 kw
Total weight of liquids (all tanks full)	600 kg

**Nota bene:** due to the trim and loading of the boat, is it not usually possible to use the whole of the various tank capacities for fresh water and diesel. You are recommended to maintain a diesel reserve of 20%.

## III. ELECTRICAL SYSTEMS

### ***Safety and operating instructions for the electrical system (ISO 10133)***

#### **WARNING**

Improper use of the DC and/or AC systems may give rise to fire or explosion hazards.  
Improper use of the AC systems may give rise to electric shock hazards.

Always:

- Check the condition of the batteries (charge and electrolyte level) and the charging system before putting to sea.
- Disconnect and remove batteries for wintering.
- Do not let battery voltage drop below 10.5V during wintering.
- Carry spare lamps for all navigation lights and interior lighting. Respect power ratings, particularly for navigation lights.
- Check operation of the navigational instruments.
- Check operation of navigation lights before night sailings

Never:

- Work on an electrical installation that is live.
- Make any modification to an installation and the relevant diagrams, unless it is carried out by an electrician qualified in marine electrics.
- Change or modify the breaking capacity of overload protection devices.
- Replace electrical apparatus or equipment with units exceeding the rated capacity without upgrading wiring and protection.
- Leave the boat unattended when the electrical installation is powered, with the exception when applicable of the automatic bilge pump and the fire or theft protection circuits.

If a fuse or circuit-breaker blows continually, you should consult a specialist to determine the cause of the short-circuit.

### ***Installing new equipment***

Since 1 January 1996, electrical equipment is subject to the European “electromagnetic compatibility” directive (Ref 89/336/CEE). So new equipment being installed must meet this standard and bear the CE mark. Equipment must also be supplied with a compliance certificate and instructions for use.

In the case of 220 or 110 V installations, use only double-insulated or earthed equipment. When such equipment is being installed, respect the fitting instructions (conductor size, protection).

To avoid maintenance problems, be sure to mark in the manual any modifications that may be made to the electrical circuit diagram.

## **Batteries**

There are two 100 Ah auxiliary batteries in the technical space between the aft bunks and a 75 Ah battery under the saloon companionway for starting the engine.

Their capacities have been designed to handle the power requirements of the on-board accessories. To avoid any problems, it is necessary to keep a close eye on the maintenance and correct charging of the batteries.

### **NOTE**

When installing new electrical appliances, take care that the overall consumption of these appliances remains within the capacity of your batteries.

Always disconnect the negative (-) battery terminal before the positive (+) terminal.

Never allow a conductive object (tools, etc.) to bridge across the two battery terminals.

When handling batteries, keep them horizontal to avoid spillage of electrolyte. Wear gloves and protective clothing that will prevent any risk of contact with electrolyte in the event of a leak.

In the event of electrolyte splashes, rinse the affected part of the body copiously and consult a doctor.

## **Electric windlass**

### **NOTE**

It is essential to run the engine with the throttle slightly open when using the electric windlass.

## 220 / 110 Volt installation

### DANGER

The on-board 220V installation is protected by a circuit breaker and fitted with a residual current device. The wiring of additional 220V on-board accessories must be carried out by professionals, and the master circuit-breaker updated if necessary.

- Disconnect the boat's power supply when system is not in use.
- Connect the metal cases or housings of installed electrical equipment to the ship's protective conductor (green or green / yellow wire).
- Use double-insulated or earthed electrical appliances.

### DANGER

Your boat is delivered without a supply cable or shore connection plug. The cable used must be designed for exterior use. Its cross-sectional area must be appropriate for its length and the rating of the main circuit-breaker (see electrical diagram). The plug must be suitable for the socket on the shore (if necessary, seek the advice of a professional). It should be as close as possible to the **IP 67 / IEC529** type

In order to minimize the risk of electric shock or fire:

- Switch off the shore supply at the on-board isolator before connecting or disconnecting the shore/boat supply cable.
- Connect the shore/boat supply cable at the boat end before connecting it to the shore outlet
- Disconnect the shore/boat supply cable at the shore outlet before disconnecting it at the boat end
- Close the shore outlet cover properly
- Do not make modifications to the shore supply cable; use only compatible connectors.

**Never:**

- Go swimming close to a boat connected to a shore supply socket: danger of electrocution!

**Warning!** When the boat is moored at the quayside, set the isolator to the 'off' position.

Location of the 220 V master circuit-breaker: by the chart table.

During haul-out maintenance, set to the 'on' position in order to have **earth [grounding] protection** via the shore socket.

### WARNING

Never let the end of a ship/shore supply cable dangle into the water. It may create an electrical field that could injure or kill nearby swimmers.

## IV. GAS INSTALLATION

### **Operating advice**

- Read carefully all instructions for cooker and regulator before use or maintenance.
- Ensure that the gas cylinder and regulator are in accordance with the requirements of the cooker (flow rate, pressure, type of gas) and with the regulations in force in the country where it is being used.
- Make sure the appliance gas taps are closed before opening the valve on the cylinder.

#### **WARNING**

Fuel-burning naked-flame appliances use up the oxygen in the cabin and release combustion products inside the vessel. Proper ventilation is necessary: open the designated vents while these appliances are being used.

Never block the ventilation openings and check that appliances with flues are working properly.

- Do not use the stove as a means of heating.
- Do not obstruct quick access to the elements of the gas installation (cylinder locker, shut-off valve).
- The gas cylinder must always be stowed in the sealed, ventilated space provided. The same applies to spare or empty cylinders. No other equipment must be stowed in this space.
- Never leave the boat unattended when gas appliances are on.
- Close all valves in the circuit when the boat is left empty (shut-off valve, regulator valve), even if the cylinder is believed to be empty.
- After the boat has been shut up, never smoke when going below, and ensure that there is no smell of gas.
- If you smell gas, close the circuit valves and the cooker taps, ventilate the boat, and find the leak before using the installation again.

#### **WARNING**

In the event of an emergency, the circuit valves must be closed immediately.

#### **SAFETY PRECAUTIONS**

Certain precautions must be taken to avoid any contact with naked flames or other hot areas.

## Checking the system

- The gas system must be tested periodically:
  - Close all cooker taps.
  - Open the cooker supply and regulator valves.
  - Check that all connections are gas-tight using a leak detector or by applying soapy water.

### **ATTENTION!**

Do not use solutions containing ammonia.

### **DANGER!**

Never use a flame to look for leaks.

Repairs and modifications to the system should be carried out by a qualified person.

Flexible hoses must be:

- Checked regularly, at least once a year,
- Replaced if the expiry date marked on the hose is passed,
- Replaced five years after the date of manufacture that may be marked on them,
- Replaced in the event of damage.

## Changing the gas cylinder

### **DANGER!**

Close the cooker taps and those before the cooker.  
Do not smoke nor use a naked light during replacement of the gas cylinder.  
Ventilate the gas cylinder compartment well when loading the cylinder.

### **WARNING!**

In the case of an LPG installation:  
- refrain from smoking or using a naked flame while LPG cylinders are being changed  
- close the valve on the empty cylinder before disconnecting it to change.

## V. DRAIN & SANITATION SYSTEM

### **Specifications of the drain system**

Pump type	Theoretical flow rate
Manual	30 L/min
Electric 12V	17.5 L/min

Read carefully the operating and maintenance instructions for the bilge pump that goes with your boat.

#### **ATTENTION!**

The level of the water in the bilge must be kept to a minimum.

#### **WARNING!**

The bilge pump system is not designed to handle water entering as a result of holing of the hull. It is intended to remove water coming from spray, leaks from seacocks or other moderate leaks.

#### **SAFETY PRECAUTION**

- Ensure that bilge pumps are in working order before putting to sea.
- Regularly clean away any debris that might obstruct the sump well and the pump intake points or strainers.

If the watertight bulkheads that isolate the fore- and after-peaks are fitted with valves, these should normally be kept closed and only opened in order to drain the water into the main bilge

- Know where to find each hand pump and its handle
- Locate the switch for the electric bilge pump on the electrical panel.

### **Pressurized fresh-water pump**

Fresh water is supplied to the sink and washbasins by an electric pump. A filter is installed upstream of the pump, and must be cleaned regularly.

**Never allow the pump to run if the tank is empty. Refill the tank before using the water supply again.**

The tanks can be sterilized using Clonazone® tablets (available from pharmacies). Every year, remove the inspection covers and clean them by filling with water containing a bactericidal detergent; leave it to act for a few hours, then rinse two or three times. During wintering, fill the tanks up completely to avoid the development of algæ or bacteria, or if there is a risk of freezing, empty the tanks; never use anti-freeze.

Hot water is produced by a water-heater connected to the engine cooling circuit and the shore electric supply.

After the water-heater has been emptied, make sure that the element is covered before power is re-applied.



## Seacocks

Seacocks are of the ¼-turn type:

- : handle in line with seacock body,
- CLOSED position: handle perpendicular to seacock body.

OPEN position

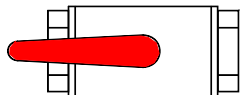

CLOSED position

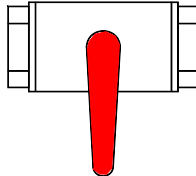

### ATTENTION!

Never interfere with the tightening of the seacocks to the hull. In the event of a leak, consult a professional.

In bad weather or when leaving your boat, close all the sanitation system seacocks.

Keep seacocks closed when not being used.

During wintering, clean and rinse the seacocks and skin fittings. Inspect the brass accessories; slight surface corrosion is normal.

In the event of more serious corrosion, consult your agent.

## Operation of the sea toilets

- Open the sea-water inlet seacock.
- Open the bowl emptying seacock.
- Set the lever to the “FLUSH” position.
- Operate the pump.
- To empty the bowl and avoid any water slopping when heeling, set the lever to the “DRY BOWL” position.
- Operate the pump until the bowl is dry.
- Repeat these flushing / emptying operations as many times as is necessary to ensure complete emptying of the pipes.

When toilets are not being used, set the lever to the «DRY BOWL» position, or the «CLEF» position for certain models.

- **Close seacocks after use, as the toilet is below the waterline.**
- Change the toilet seals regularly.

## Holding tank operation

### WARNING!

Where a HOLDING TANK is fitted, take care to lock the valve into the EVACUATION TANK position, to avoid any accidental discharge during wintering.

- The sewage tank (50 l) is operated using the manual toilet pump.
- The contents of the toilet pan are discharged straight into the holding tank;
- Periodically check that the vent is working properly.
- A deck plate is provided for emptying the tank
- The discharge valve can be sealed in the closed position.
- Once a season, arrange to clean out the tank using a biodegradable disinfectant chemical. Leave the system empty if the vessel is to be left in below-freezing temperatures

## VI. FLOODING

Boat flooding risks:

- Before putting to sea, always check that portholes, deck hatches and any other openings that could allow flooding are shut.
- When under sail, close all seacocks, except the engine water intake.
- Periodically check:
  - Skin fittings, seacocks and pipes are watertight
  - Proper emptying of the cockpit drains.
  - The watertightness of the stern gland (in the case of an IB engine).

### WARNING!

Cockpit locker lids must be fastened shut before putting to sea. This is particularly important for those lockers that represent a major flooding risk.

## VII. FIRE PROTECTION

### *Installation*

- Fire-extinguishers are subject to national regulations, and for this reason they are not supplied with your boat.
- We recommend you to equip your boat with fire extinguishers meeting the ISO 9094-1 standard, with the following specifications:
  - a) Minimum capacity per extinguisher: 5A/34B(\*)
  - b) Minimum combined extinguisher capacity: 10A/68B(\*)  
(\* ) As per the ISO/WD 9094-2 standards
  - c) 1 extinguisher within:
    - 1 m (for boats < 10 m) or 2 m (for boats > 10 m) of the cockpit
    - 2 m of the extinguisher opening for dowsing the engine,
  - d) 1 extinguisher within 2 m of the cooker,
  - e) 1 extinguisher within 5 m of the bunks.
  - f) CO2 extinguishers may be placed in accommodation areas only where flammable liquids are present (e.g. galley) or where there is powered electrical equipment. There must not be more than one CO2 extinguisher per area at risk, and its maximum capacity must not exceed 2 kg.

Only compatible replacement parts must be used in fire protection systems. They must bear the same markings and be technically equivalent.

In addition, a fire blanket should be stored close to the galley — very useful particularly in the event of a pan fire involving oil.

## WARNING

If a CO<sub>2</sub> extinguisher is fitted, the following information must be displayed close to its location:  
***“This extinguisher contains CO<sub>2</sub> - use only on electrical or cooker fires. To avoid suffocation after discharging, leave the area immediately. Ventilate before re-entering.”***

Do not open the engine compartment immediately after putting out a fire, to avoid the release of toxic smoke or spraying of burning materials (oil, water).

## Safety instructions

### NOTE

It is the responsibility of the owner / skipper to:

- Have fire-fighting equipment checked in accordance with the stipulations of the builder and the regulations in your country.
- Replace fire-fighting equipment if it has expired or been discharged, by extinguishers of equal or greater capacity.
- Show members of the crew:
  - The location and operation of fire-fighting equipment
  - **The location of the engine compartment extinguishing hole (located on the companionway).**
- Ensure that fire-fighting equipment is readily accessible whenever the boat is occupied.
- Always keep the bilges clean and check that there is no fuel vapor or gas.

**Never:**

- Sit on the hulls when the boat is going fast
- Obstruct gangways to emergency exits (deck hatches)
- Obstruct safety controls (gas valves, fuel valves, electrical switches).
- Obstruct fire extinguisher stowages.
- Leave the boat unattended with a cooker or heater alight.
- Use a gas lamp in the boat
- Fill a fuel tank or change a gas cylinder while the engine is running, or the cooker or heater are alight.
- Smoke while handling fuel or gas.
- Fit free-hanging curtains near the cooker or any other appliance using a naked flame.
- Store flammable products in the engine compartment.

## VIII. ENGINE

Regular maintenance must be carried out in accordance with the engine manufacturer's recommendations. Read care-fully the engine operating instructions that come with the boat. Do not hesitate to consult your agent or a qualified professional.

In particular, follow the instructions for wintering.

### **General precautions**

#### **NOTE**

Do not use sail and engine if the heel angle is more than 10°  
Any engine change must respect the capacities of the boat and be performed by an engineer specializing in marine mechanics.

#### **NOTE**

After first launching and tensioning of rigging, check the alignment of the propeller shaft or the sail-drive flange ring.  
Ensure that the cooling circuit water intake seacock is open, and that water is coming out of the engine exhaust.  
Boats fitted with rotating seal stern gland: bleed the air from the gland after each launch.

On subsequent launches, a brief check of propeller fixing can be made. Incorrect operation of the folding propeller will lead to vibration

Regularly check the condition of the anodes and ensure that they are suitable for the boat's environment (fresh water, salt water). Change the anodes every year.

The role of the sacrificial anodes is to balance the potential that appears between the aluminium and the various metals (stainless, bronze, etc.). The anodes have an average life of 1–2 years.

These anodes are made of zinc. It is essential not to use magnesium ones. Impressed current cathodic protection systems should not be used

If the anodes are not eroded, you need to check:

- that they have not been painted over,
- that they are correctly fixed and in contact with the hull,
- and that they are indeed made of zinc

### **Exhaust gas emission**

#### **DANGER!**

Internal combustion engines produce carbon monoxide. Prolonged exposure to exhaust gasses can have serious consequences, and may even cause death.

### **Safety**

#### **DANGER!**

In order to avoid all risk of serious injury from the propeller, the engine must not be started when there are people swimming near the boat.

Whenever possible, the engine must be stopped for any engine maintenance or checking operations. If this is impossible, then particular care must be taken with moving parts (belts, shafts, etc.) to avoid any danger of injury.

## Wintering

Read carefully the operating and maintenance instructions for the engine that goes with your boat and the instructions for wintering.

In the absence of other instructions, proceed as follows:

- Close the engine water intake seacock,
- Disconnect the pipe from the engine water intake seacock,
- Drain the sea-water circuit,
- Place the pipe into a drum of  $-25^{\circ}$  anti-freeze coolant,
- Run the engine until the fluid comes out of the exhaust,
- At the end of this operation, re-connect the pipe to the seacock,
- Attach a notice to the electrical panel and the battery isolator to the effect that the engine water intake seacock is closed.

## IX. FUEL INSTALLATION

In the event of deterioration, flexible fuel pipes must be replaced by pipes bearing the same markings.

### ATTENTION!

Depending on the trim and loading of your boat, the whole of the nominal fuel capacity may not be usable. Always maintain a 20% reserve for safety.

Avoid contact between flammable materials and hot parts of the engine.

#### Never:

- Store flammable materials in unventilated spaces.
- Smoke while filling tanks.
- Obstruct ventilation openings (vents, engine ventilation grilles).
- Modify the installation, unless this is carried out by a technician qualified in this field.

## X. STEERING SYSTEM

The steering system plays a vital role in the safety and comfort of your boat.

### Helm

The **DUFOUR 375** is fitted with dual steering wheels with rudder cable system and an emergency tiller.

Checks to be carried out periodically: Check the play in the various elements (rudder stock/bearings, tension and wear in mechanical components) and grease the sprocket and chain if necessary.

In the event of any doubt or problem, consult your agent.

## Emergency tiller

### NOTE

The DUFOUR 375 is provided with an emergency tiller that must be kept readily accessible — we recommend it should be stowed in the cockpit locker close to the deck-plate for it. It is only designed for sailing at reduced speed in the event of damage to the helm.

To use it:

- unscrew the deck-plate to reveal the head of the rudder stock using the stainless steel key provided
- fit the tiller onto the head of the rudder stock.

## XI. SAILING

### WARNING

In all situations, make sure you adapt the speed of your boat to the surrounding conditions, and always maintain a margin for safety. Pay particular attention to:

- Other boat movements
- Manœuvres in port
- When passing through mooring areas.
- The state of the sea, currents, the strength of the wind. Breaking waves represent a

significant threat to stability;

When at sea, carefully attach any movable items aboard.

Obey the rules of priority as set out in the Rules of the Road and imposed by COLREG

Ensure you always have sufficient stopping or maneuvering distance if necessary to avoid a collision  
Respect speed limit areas.

Out of courtesy and for the safety of other vessels, take care not to create excessive wash close to other craft.

In all cases, make sure you keep regularly up to date with local rules, as well as the international regulations (Marpol).

### WARNING

You should fit your boat with life-lines. Anchor-points are provided on the deck. Please refer to the deck fittings plan for your boat.

Your boat's stability has been designed to take into account the boat builder's catalogue options. Any alteration to on-board weight distribution (for example: adding a radar, changing an engine, etc.) can have an appreciable effect on your boat's stability, trim, and performance.

Towing a boat creates significant overloading, reducing the stability of your boat.

For the same reason of reduced stability, **never:**

- use the boom or davits to lift heavy loads.

## XII. LIGHTNING PROTECTION

Your boat is protected against lightning. The rigging is electrically connected to earth. Nonetheless, for your safety, it is necessary to respect certain precautions.

### **Maintenance**

If the vessel has been hit by lightning:

- The protection installation must be inspected to detect physical damage and check the integrity of the device, as well as the continuity of the earthing.
- The compasses, electrical and electronic devices must be examined in order to ascertain if damage or calibration changes have occurred.

### **Protection of persons during a storm**

#### **WARNING**

During a thunderstorm, it is preferable to obey the following instructions:

- People should stay below as far as possible.
- People should stay out of the water and not let their arms or legs hang into the water.
- Whilst maintaining satisfactory control of the boat and its sailing, people should not touch any part connected to a lightning protection installation, especially not in such a way as to form a link between such parts.
- It is desirable that people should avoid any contact with metal parts of the rigging, the spars, deck fittings and the lifelines.

## XIII. ENVIRONMENTAL PROTECTION & SAFETY

We recommend you to find out about local regulations concerning respect for the environment, and to obey international regulations against pollution in the marine environment (MARPOL), together with the codes of good practice.

#### **ATTENTION!**

Most cleaning products, engine oils and hydrocarbons are likely to affect the environment, so they should be discharged in authorized locations (check with the Harbour Master's office).

Do not start the bilge pump where oil or fuel is present in the engine compartment, as these chemicals must be discharged in authorized locations.

Certain chemical products may also represent a risk for your own and other people's safety, which is why it is important to read and obey the instructions for use.

Substances used must be labelled and stored in an appropriate, ventilated place in the boat.

## XIV. SAFETY FACILITIES

There is no harmonization of mandatory safety equipment across the European Community. You should find out about current national requirements for CE-marked vessels.

In France, the skipper is responsible for ensuring that recreational craft bearing the CE mark carry aboard the mandatory handling and safety equipment stipulated for the relevant sailing category.

Your boat is provided with a stowage position for a life-raft, read the life-raft instruction manual carefully. The crew must be made familiar with the use of all the safety equipment (harnesses, flares, life-raft, etc.). Sailing schools and clubs regularly organize training sessions.

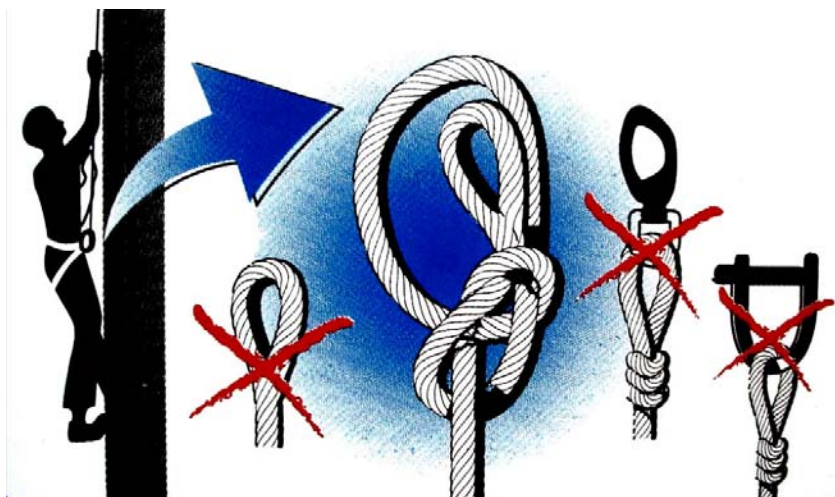

Advice for hoisting a person up the mast

## XV. HANDLING, TRANSPORTING, HAULOUT

When craning, take care that the slings are correctly positioned and are not fouling the propeller, the sail-drive or a fragile transducer.

Lifting frames must be wide enough, or fitted with spreaders, so as to avoid applying excessive lateral pressure on the rubbing strakes.

Avoid allowing slings to foul the life-lines. During transport or haulout, the keel should be in proper contact with its support and should be taking most of the boat's weight.

Cradle pads must be positioned against structural elements and exert only the pressure necessary for the boat to be properly balanced.

Take advantage of the opportunity provided by haul-outs to inspect the propeller, rudder, skin fittings, and transducers.

### **ATTENTION!**

Aft lifting point is located near the sail-drive



# Charte pour la mer et les rivières

*L'eau est un milieu vivant, fragile.  
C'est aussi une ressource précieuse.*

Pour protéger ce milieu,

- Je respecte la mer et les rivières, je n'aborde pas les sites protégés, je limite ma pêche aux espèces et tailles autorisées, j'observe les animaux sans les toucher ni les déranger.
- Avant de mouiller, je m'informe de la nature du fond pour éviter sa dégradation. De préférence, j'utilise les bouées d'amarrage.
- Je dépose mes déchets ménagers dans les containers et mes déchets toxiques, solides et liquides à la déchetterie portuaire.
- J'utilise les installations sanitaires portuaires. Je vidange mon bac à eaux noires dans les stations de pompage. J'utilise les produits détergents les plus respectueux de l'environnement.
- Je m'assure que toute opération d'entretien (bateau, matériel, équipement) est effectuée dans le respect de l'environnement. Je manipule avec précaution tous les liquides susceptibles de polluer lors de leur transvasement.

1 Décembre 1999





## Au service des plaisanciers et des professionnels de la mer

### *Les sauveteurs en mer veillent...*

Tous les marins savent qu'on ne badine pas avec la grande bleue ... Malgré les progrès considérables réalisés en matière de sécurité par les constructeurs de bateaux, un événement de mer est toujours possible et vous pouvez avoir un jour besoin des « sauveteurs en mer ».

À toute heure du jour et de la nuit, 7 jours sur 7, 3 500 bénévoles sont prêts à appareiller dans la demi-heure pour aller porter secours à ceux qui sont en difficulté ... et cela parfois au péril de leur propre vie !

C'est grâce au maillage très serré de ses 255 stations en France et dans les D.O.M. que « Les Sauveteurs en Mer » assurent aujourd'hui près de 50% du sauvetage en France.

### *En mer, vous pouvez avoir besoin d'eux, à terre ils ont besoin de vous...*

Le sauvetage des vies humaines est gratuit mais les moyens mis en oeuvre coûtent cher. Les sauveteurs en mer, qui se recrutent de plus en plus parmi les plaisanciers, ont besoin de vous pour entretenir, moderniser et remplacer leurs moyens nautiques (1 canot tous temps coûte 4,2 MF !).

Venez donc soutenir ou même rejoindre ces marins, hommes et femmes, désintéressés, discrets et efficaces : prenez contact avec le responsable de la station la plus proche du port d'attache de votre bateau ou avec notre siège à Paris.



### ENTRE MARINS...



- avant de prendre la mer, informez vos proches de vos intentions
- renseignez vous sur les conditions locales (météo, courant, etc)
- possédez des moyens radio VHF fiables et contrôlez-les
- faites porter un gilet de sauvetage aux enfants

**UNE VIE HUMAINE N'A PAS DE PRIX ...,  
UN CANOT DE SAUVETAGE EN A UN !**

LES SAUVETEURS EN MER (S.N.S.M.)

Siège social: 31, cité d'Antin 75009 PARIS

Tel: 01 56 02 64 64 - Fax: 01 56 02 64 63 - E-mail: [www.snsfm.com.fr](http://www.snsfm.com.fr)



### *Je soutiens la SNSM et j'adhère !*

Je joins un chèque de:  20 € min.       45 €      (donateur) -  380 €      (bienfaiteur)

Un reçu de déductibilité fiscale me sera adressé avec la carte et l'autocollant de membre

NOM:.....PRENOM:.....  
ADRESSE:.....  
Téléphone:.....email:.....

# XVI. GUARANTEE, TRANSFER OF OWNERSHIP

## A) CONTRACTUAL GUARANTEES

Note: This guarantee does not apply to boats being used for commercial purposes (it being specified that any hiring or chartering activity falls into this category) nor to sailing boats taking part in competitions, which may be covered by special guarantees.

### 8 - Guarantees

#### a) New boats and equipment:

8.1.1 – For both Commercial Purchasers and private consumers domiciled outside the territory of the European Union, the Seller is required to furnish the statutory guarantees defined (in the context of the sale of vessels) by Articles 1641 and 1648 of the French Civil Code and (in the context of a marine construction contract) by Articles 7 and 8 of Act no. 67.5 dated 3rd January 1967 pertaining to vessels.

8.1.2 – For Purchasers domiciled within the territory of the European Union and taking out the contract as private consumers, the Seller is required to furnish the guarantees as defined in the context of a boat sales contract by Articles 7 and 8 of the Act dated 7/1/1967 pertaining to vessels, and in the context of the Order (2005-136) dated 17/2/2005 and incorporated into the French Consumer Code. Independently of this guarantee, the Seller remains liable for discrepancies between the goods and the contract and for redhibitory defects under the conditions provided for under Articles 1641 to 1649 of the French Civil Code (see 8.1.1).

8.2 – Visible defects: acceptance by the Purchaser releases the Seller from their obligation in respect of discrepancies and visible defects.

#### 8.3 - Contractual guarantee:

Except for guarantee or penalty clauses expressly agreed at the time of accepting the order, the Seller's guarantee is granted under the following conditions:

- The Purchaser benefits from a contractual guarantee running for two years from the date of acceptance of the vessel, as noted on the acceptance report.
- This is limited to the replacement or free repair, at the yacht-builder's discretion, of any parts acknowledged as being defective by the yacht-builder's technical services; this being without any other compensation of any kind.
- For components and accessories visibly bearing the mark of another supplier, the guarantee is limited to the guarantee offered by that supplier.
- It is stipulated that any handling, transport, parking, or conveying costs incurred in carrying out these operations remain the sole liability of the buyer/user, unless **DUFOUR YACHTS** yacht-builders offer to waive them in full or in part.

- The yacht-builder's contractual guarantee excludes:
  - the cost of transporting the boat or any parts, and any consequences thereof, together with expenses and/or any damage arising out of the inability to use the boat and/or the equipment;
  - normal wear and tear;
  - cracking, crazing, or discolouration of the gelcoat;
  - damaging resulting from:
    - fortuitous events or cases of force majeure;
    - conversions and modifications, or repairs, even partial, carried out other than in work-shops authorized by the maker;
    - failure to observe the maintenance recommendations set out in the Owner's Manual supplied with the boat;
    - improper use, in particular through negligence, carelessness, abuse, or abnormal usage;
    - participating in competitions;
    - failure to take necessary protective measures;
    - unsuitable storage or transport conditions.

In order to benefit from the yacht-builder's contractual guarantee, each time they make a claim under it, the buyer/user will be required to submit the boat delivery certificate and the guarantee document, duly completed, and, on pain of rendering it void, must notify their dealer/vendor of the fault or defect in writing, in detail and with justifications, within 15 days of its being discovered.

8.4 – the guarantee covers usage at sea in wind and sea conditions acceptable for safety and in accordance with the vessel's approval category. Under these conditions, it cannot under any circumstances cover events arising during or resulting from collisions, groundings, breaking seas, tidal waves, cyclones, severe storms, and all other exceptional events and/or events arising out of an error of seamanship.

8.5 – Loss of or damage to products occurring after handover do not release the Purchaser from their obligation to pay the price.

#### b) Second-hand boats and equipment:

The order form specifies if the boat or equipment is second-hand. The Purchaser benefits from a contractual guarantee, covering hull and engine only, running for one year from the date of acceptance of the vessel or goods, as noted on the acceptance report.

c) In addition to the contractual guarantee detailed above, the Seller remains liable for discrepancies in the goods and for latent defects under the conditions provided for under Articles 1641 to 1649 of the French Civil Code and the provisions of the Order dated 17/2/2005, where applicable.

## B) COMMON GUARANTEE CONDITIONS

Any claim under these guarantee conditions must be made formally to **DUFOUR YACHTS** in writing as soon as the

defect is discovered, and within eight (8) days for claims under the contractual guarantee. Any claim will also be required to quote the serial number of the boat concerned, and where applicable the part number(s) of the part(s) involved in the guarantee claim.

Furthermore, the request must indicate the exact circumstances under which the problem occurred.

In order to investigate the request **DUFOUR YACHTS** may ask for any details and appoint, at its own expense, a surveyor or technician of its choice to determine the circumstances of the occurrence of the problem and demand any necessary papers.

Immobilization following problems encountered and/or replacement and/or repair work, whatever the duration, does not create entitlement to compensation.

The owner shall under all circumstances remain liable for parking fees, customs dues and other ancillary expenses.

All repairs and/or replacements will be carried out by an authorized **DUFOUR YACHTS** agent or by a professional duly acting under the Boatbuilder's instructions. If the nature of the repairs requires the guarantee repair work to be carried out in **DUFOUR YACHTS** workshops or in any location other than the place where the Product is located, the owner will be liable for the cost of both outward and return transport to the Yacht builder.

In the event of the boat's needing to be taken out of the water, haul-out and re-launching costs will be at the owner's expense.

### C) TRANSFER OF GUARANTEES

The guarantees are afforded to the first purchaser of the boat involved. They are only transferable with **DUFOUR YACHTS'** prior written agreement.

An ownership transfer note is supplied with the Product documents. This must be sent to **DUFOUR YACHTS** within thirty (30) days of the transfer.

This note must bear the names, addresses and telephone numbers of the old owner and the Purchaser, the date of sale, and the Product's hull number.

Upon reception, **DUFOUR YACHTS** will confirm the guarantee expiry dates and specify whether the unit has received the annual inspection that gives entitlement to the continuation of the contractual guarantees.

### D) STATUTORY DECLARATIONS

#### Article L.211-4 of the Consumer Code:

*“The seller is required to supply goods that conform to the contract and to assume liability for discrepancies existing at the moment of handover. He shall likewise be liable for discrepancies arising out of the packaging, assembly instructions, or installation when he is liable for this under the contract or it has been carried out under his responsibility.”*

#### Article L. 211-5 of the Consumer Code:

*“In order to conform to the contract, the goods must:*

*1) Be suitable for the normally-expected use for similar types of goods and, where applicable:*

*- correspond to the description given by the seller and possess the qualities the latter has presented to the buyer in the form of a sample or model;*

*- present the qualities that a buyer may reasonably expect with regard to public declarations made by the seller, by the producer, or by his representative, particularly in advertising material or labelling;*

*2) Either present the characteristics defined by joint agreement by the parties, or be suitable for any special usage sought by the buyer that the seller has been made aware of and has agreed to.”*

#### Article L.211-12 of the Consumer Code:

*“Actions arising out of a discrepancy lapse after two years from the date the goods are handed over.”*

#### Article 1641 of the Civil Code:

*“The seller is obliged to guarantee against latent defects in the article sold which render it unfit for its intended use, or which adversely affect this use to such an extent that the buyer would not have purchased it, or would have only paid a lower price, if he had known about them.”*

#### Article 1648, Para. 1 of the Civil Code:

*“Actions arising out of redhibitory defects must be brought by the purchaser within two years of discovery of the defect.”*

# DUFOUR

---

## YACHTS

### TRANSFER OF OWNERSHIP CERTIFICATE **TRANSFER OF OWNERSHIP**

Modèle de bateau / Boat model: .....

Hull no.: .....

From Mr: ..... Address: .....

.....

ZIP/POST CODE: ..... Town / City: ..... Tel: .....

Date of Purchase: .....

#### **BEING SOLD TO:**

Mr: ..... Address: .....

.....

ZIP/POST CODE: ..... Town / City: ..... Tel: .....

Date of Purchase: .....

Signed at ..... date .....

Seller.....Buyer

Signed for DUFOUR YACHTS on: .....

Return the copy within 15 days following the transaction to

S A V DUFOUR YACHTS 1 rue Blaise Pascal –  
17187 PERIGNY CEDEX FRANCE

# DRAWINGS

1.	<i>Presentation plan</i> .....	31
2.	<i>Accommodation layout</i> .....	32
3.	<i>Deck fittings plan</i> .....	34
4.	<i>Sail plan</i> .....	36
5.	<i>Halyard and sheet operating diagram</i> .....	38
6.	<i>220 V circuit diagram</i> .....	40
7.	<i>Charging &amp; power circuit diagram</i> .....	42
8.	<i>12 V distribution panel diagram</i> .....	44
9.	<i>12 V electrical panel terminal diagram</i> .....	46
10.	<i>12V electrical installation diagram</i> .....	48
11.	<i>220 V electrical installation diagram</i> .....	50
12.	<i>Steering system diagram</i> .....	52
13.	<i>Gas system diagram</i> .....	54
14.	<i>Abandon ship plan</i> .....	56
15.	<i>Fresh-water system diagram</i> .....	58
16.	<i>Drain system diagram</i> .....	60
17.	<i>Skin fitting location diagram</i> .....	62
18.	<i>Engine installation drawing</i> .....	64
20.	<i>Lifting diagram</i> .....	68

# 1. Presentation plan

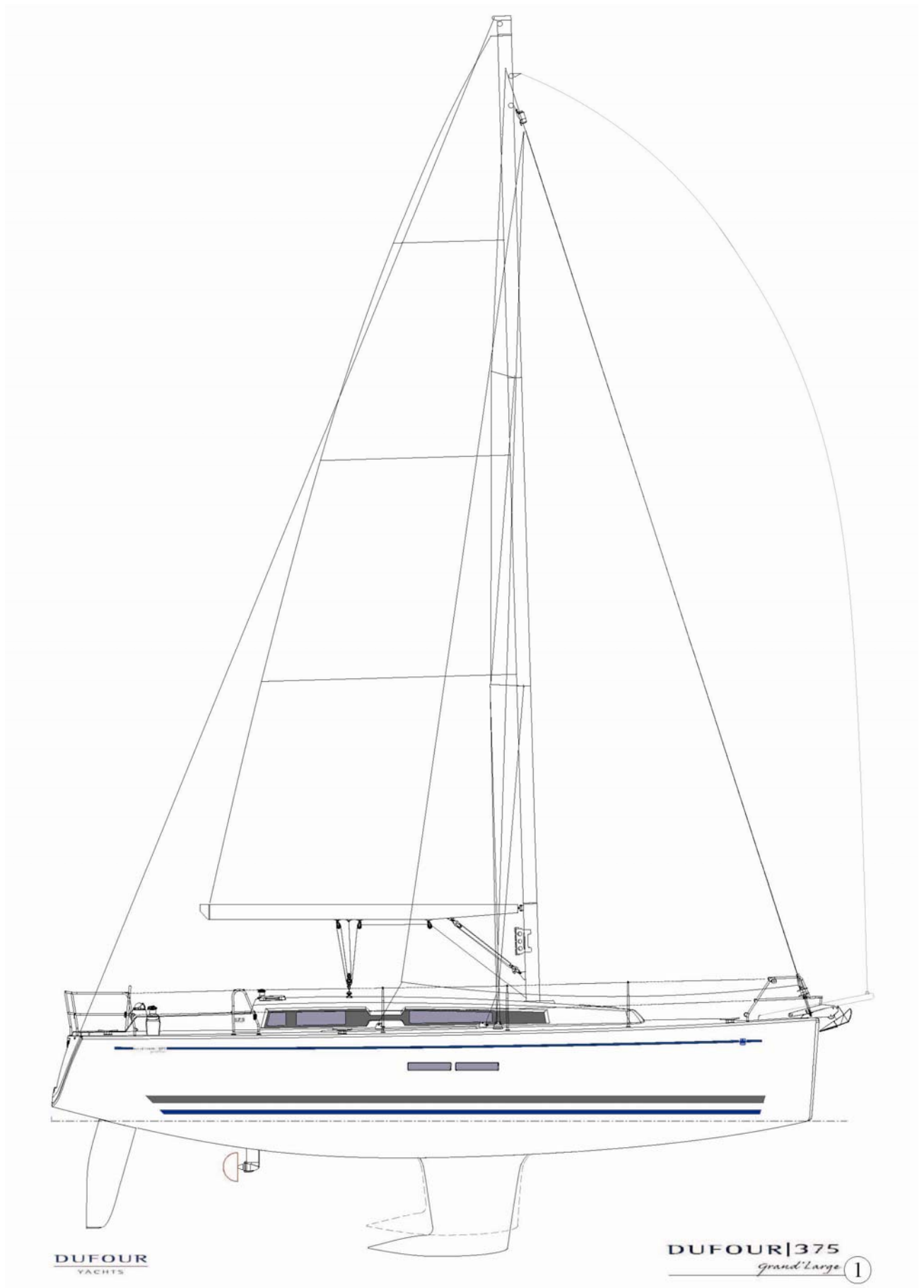

## 2. Accommodation layout

Fig. A: version 2 cabins

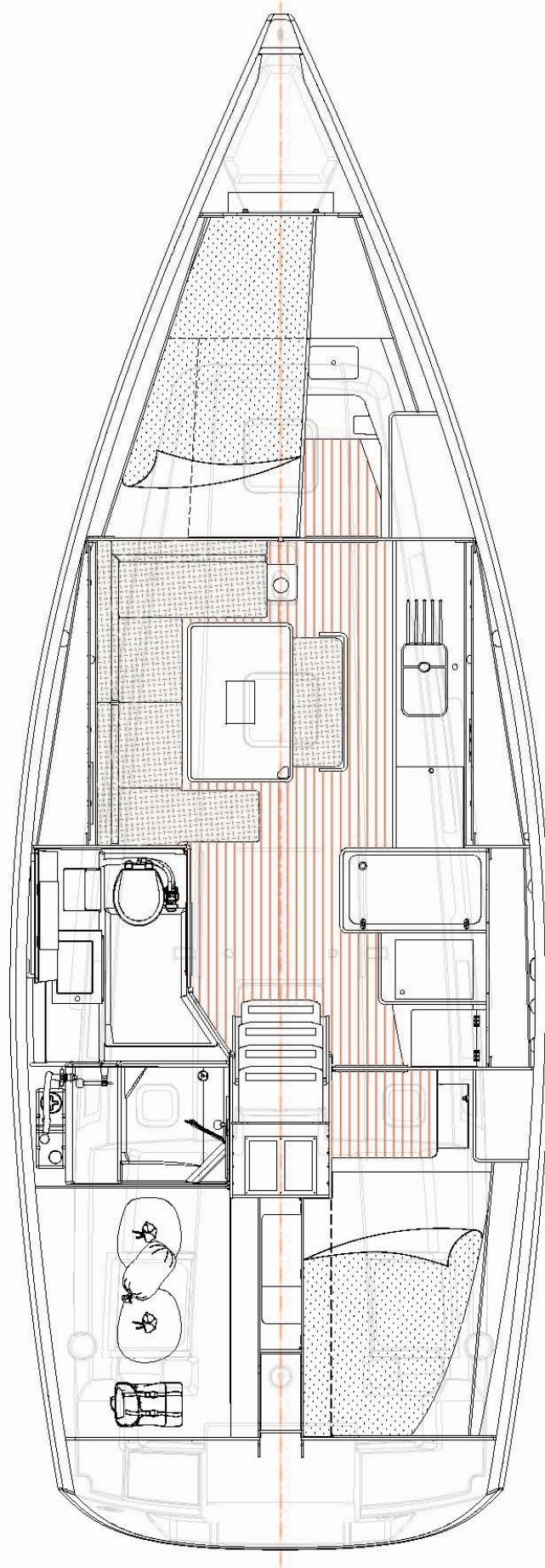

DUFOUR|375  
*Grand Large* 2

DUFOUR  
YACHTS



**Fig. B: version 3 cabins**

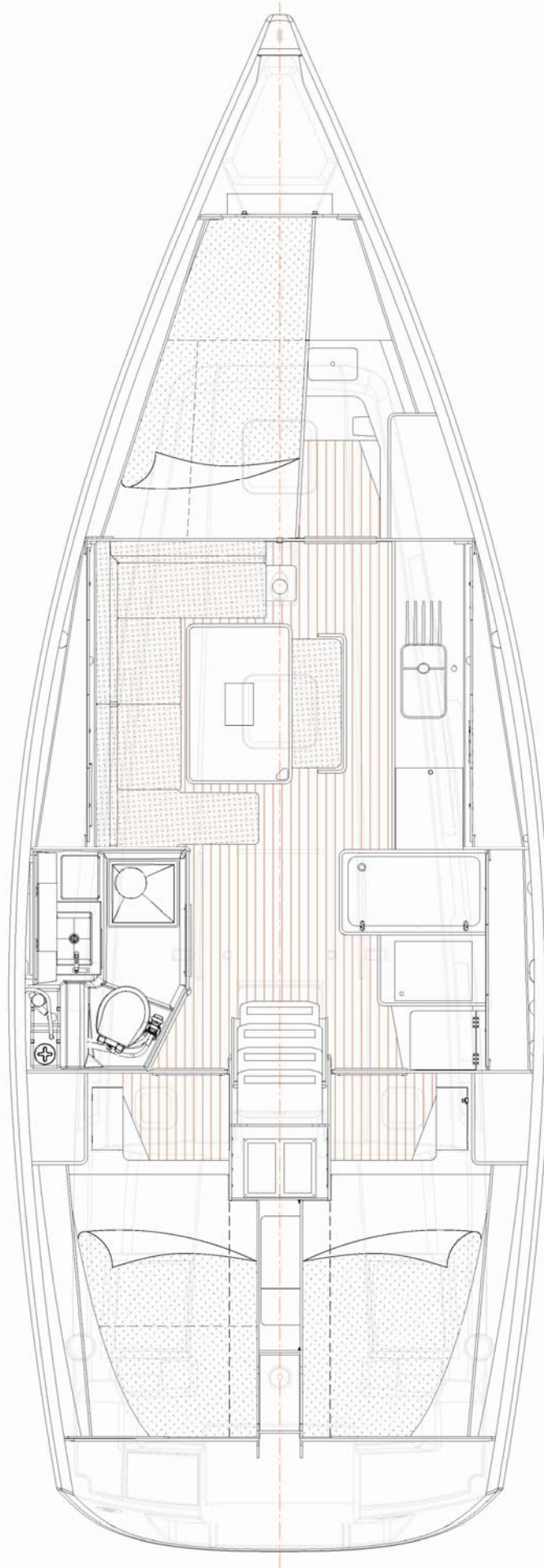

**DUFOUR**  
YACHTS

**DUFOUR|375**  
*Grand'Large* **2**

### 3. Deck fittings plan

<i>Label</i>	<i>Description</i>
1	Anchor roller
2	Releasable stay chain plate *
3	Mainsail track traveller
4	Windlass
5	Bow rail
6	Lifebelt bracket
7	Telescopic bathing ladder
8	Coachroof handrail
9	Single jam-cleat
10	Genoa sheet winch
11	Stanchion
12	Stanchion base
13	Solid teak bulwark rail
14	Fuel filler deck-plate
15	Water deck plate
16	5-sheave deck organiser
17	4-way deck organizer
18	Single chainplate for mains and lower shrouds
19	Genoa track with traveller
20	Preventer stay chain plate
21	Starboard stern rail
22	Stern Port balcony
23	Mooring cleat
24	Mainsail sheet track
25	Hinged chain-plate
26	Ratchets
27	Halyard winch
28	Crank handle holder
29	Genoa sheet pulley
30	Windlass remote control
31	Removable bowsprit*
32	Additional single davit*
33	Midship rail
A	Life-line anchor point (on port & starboard cleats)
B	Towing points (Port & Starboard)
C	Hatches must be closed when underway
D	"Man overboard": reboarding
E	Space provided for stowing life-raft
F	Anchor point for safety harness
G	Locker that must be closed when underway
*	Option

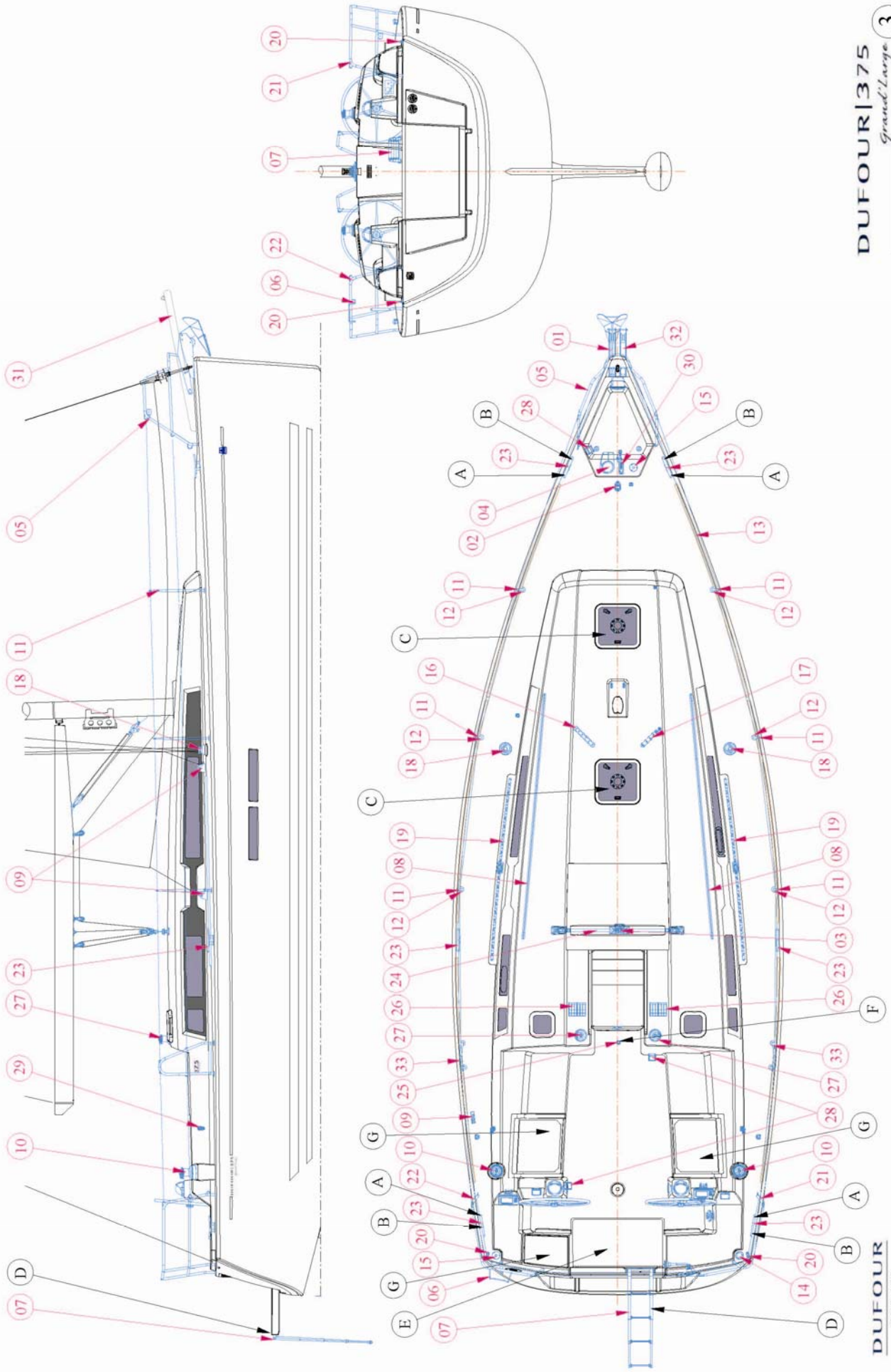

## 4. Sail plan

I	13.35 m
J	3.85 m
P	12.35 m
E	4.45 m
LP (108 % overlap)	4.15 m
LP (140 % overlap)	5.39 m
Jib area (108%)	26.80 m <sup>2</sup>
Genoa area (140%)	35.00 m <sup>2</sup>
Mainsail area	32.00m <sup>2</sup>
Asymmetric spinnaker (appx.)*	90.00 m <sup>2</sup>
Not supplied **	

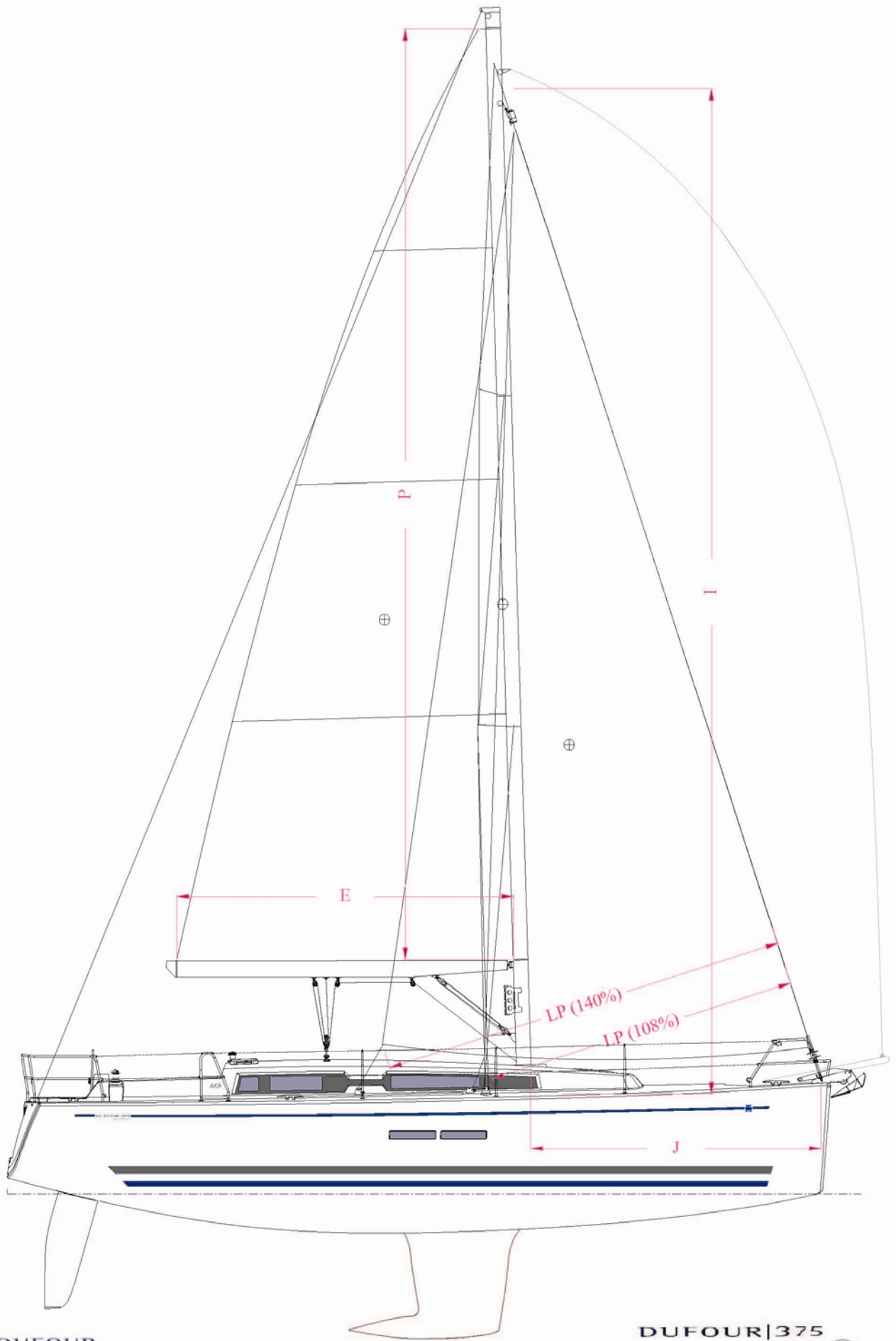

DUFOUR  
YACHTS

DUFOUR | 375  
Grand Large ④

## 5. Halyard and sheet operating diagram

<i>Label</i>	<i>Description standard mast</i>
1	Asymmetric spinnaker tack*
2	Asymmetric spinnaker halyard*
3	Releasable forestay halyard
4	Mainsail halyard
5	Mainsail sheet
6	Starboard mainsail car
7	Port mainsail car
8	Boom vang (rigid*)
9	Mainsail outhaul
10	Reef 1
11	Reef 2
12	Genoa halyard
13	Genoa sheet
14	Mainsail sheet block
*	Option

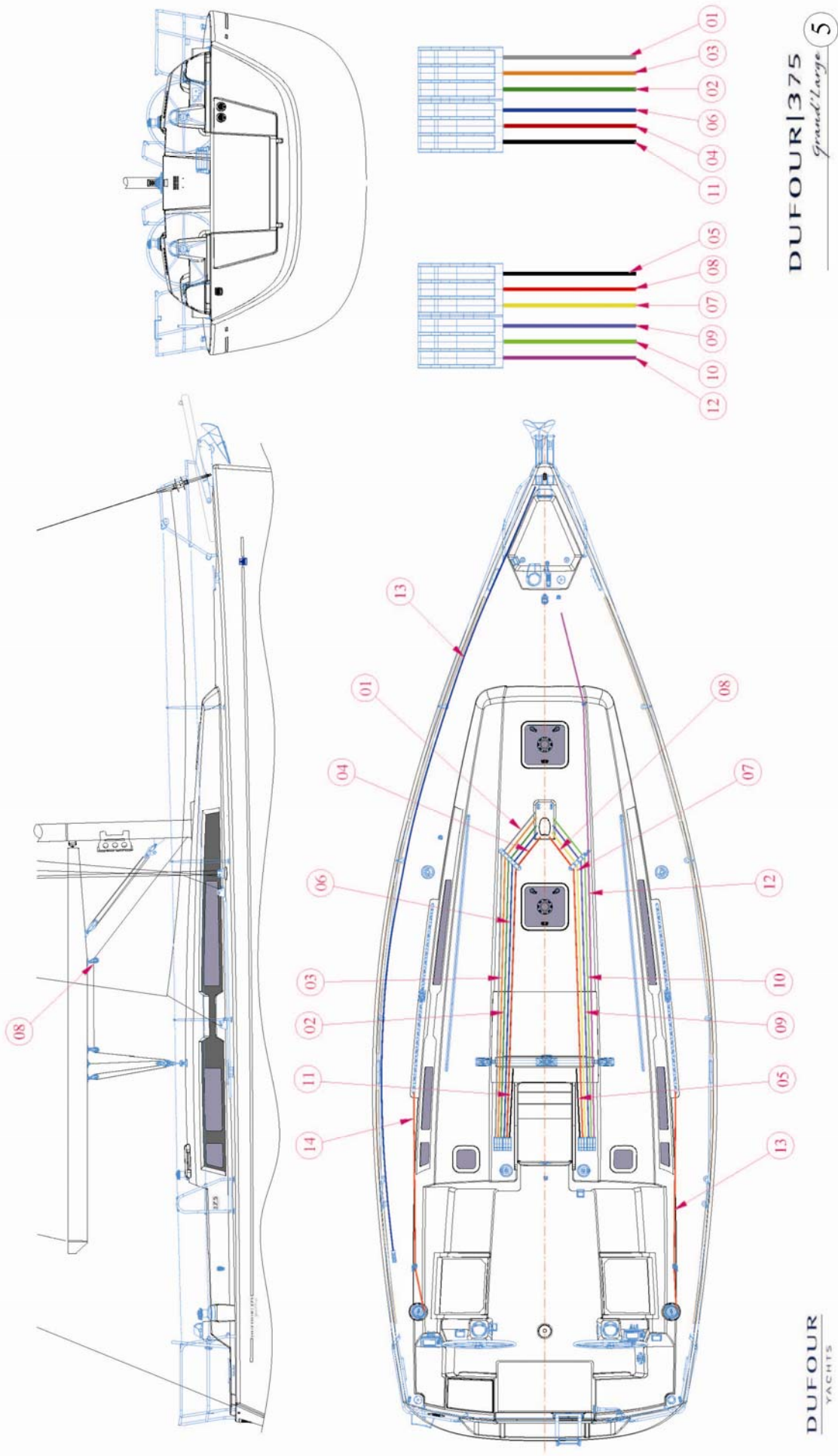

DUFOUR|375  
Grand Large 5

DUFOUR  
YACHTS

## 6. 220 V circuit diagram

<i>Label</i>	<i>Description</i>
<b><i>Equipment</i></b>	
A	Shore AC connection *
B	16A Electrical box with main circuit breaker *
C	Electrical box with 16A differential circuit-breaker*
D	220V outlets *
E	E Connector*
F	F Connector*
G	G Connector*
H	220V Shore cable **
J	Connection box *
K	Battery charger *
L	Water heater *
M	Optional equipment (e.g. microwave oven)*
<b><i>Electrical wiring colours</i></b>	
<i>b</i>	light blue
<i>g</i>	green
<i>m</i>	brown
<i>n</i>	black
<i>r</i>	red
<i>v</i>	green/yellow
<i>w</i>	white
*	Option
**	Not supplied



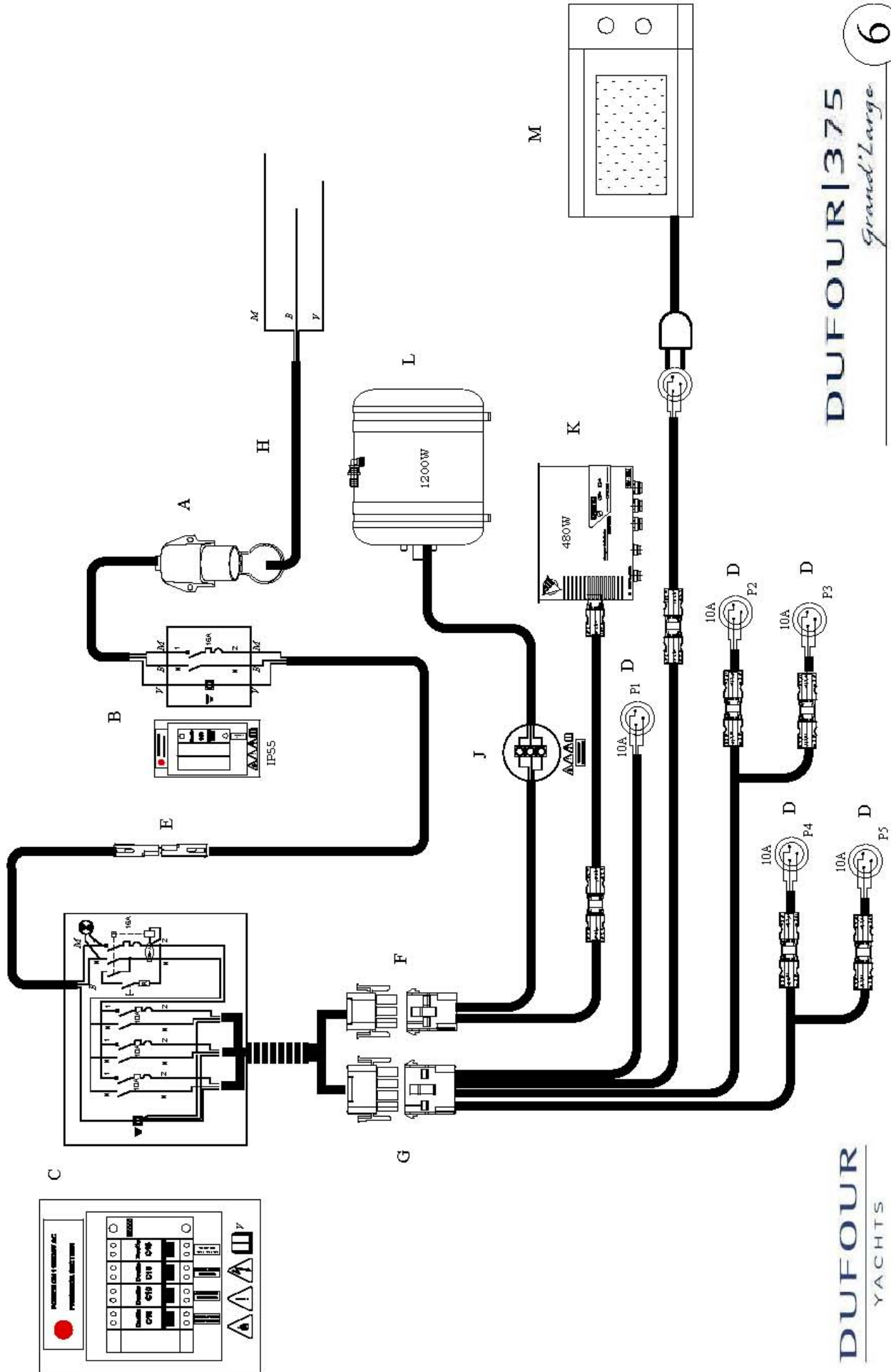

**DUFOUR** | 375  
*Grand'Large*

**DUFOUR**  
YACHTS

## 7. Charging & power circuit diagram

<i>Label</i>	<i>Description</i>
A	Windlass *
B	Windlass remote control *
C	Remote control relay *
D	8 A fuse
E	Battery charger *
F	12V distribution panel
G	Single-pole 100 A circuit breaker*
H	Auxiliary batteries (1 as std + 1 as option*)
I	5A fuse (auxiliary)
J	House batteries switch
K	5 A fuse*
L	Alternator
M	Splitter
N	Starter
O	Engine battery
P	Engine battery isolator
Q	Windlass relay*
R	Bilge fan relay
S	5A fuse
T	Bilge fan
B-	-ve terminal (electrical panel)
B+	+ve terminal (electrical panel)
W	Battery test
Y	Panel for auto bilge pump option
Z-	-ve terminal (technical area)
Z+	+ve terminal (technical area)
*	Option

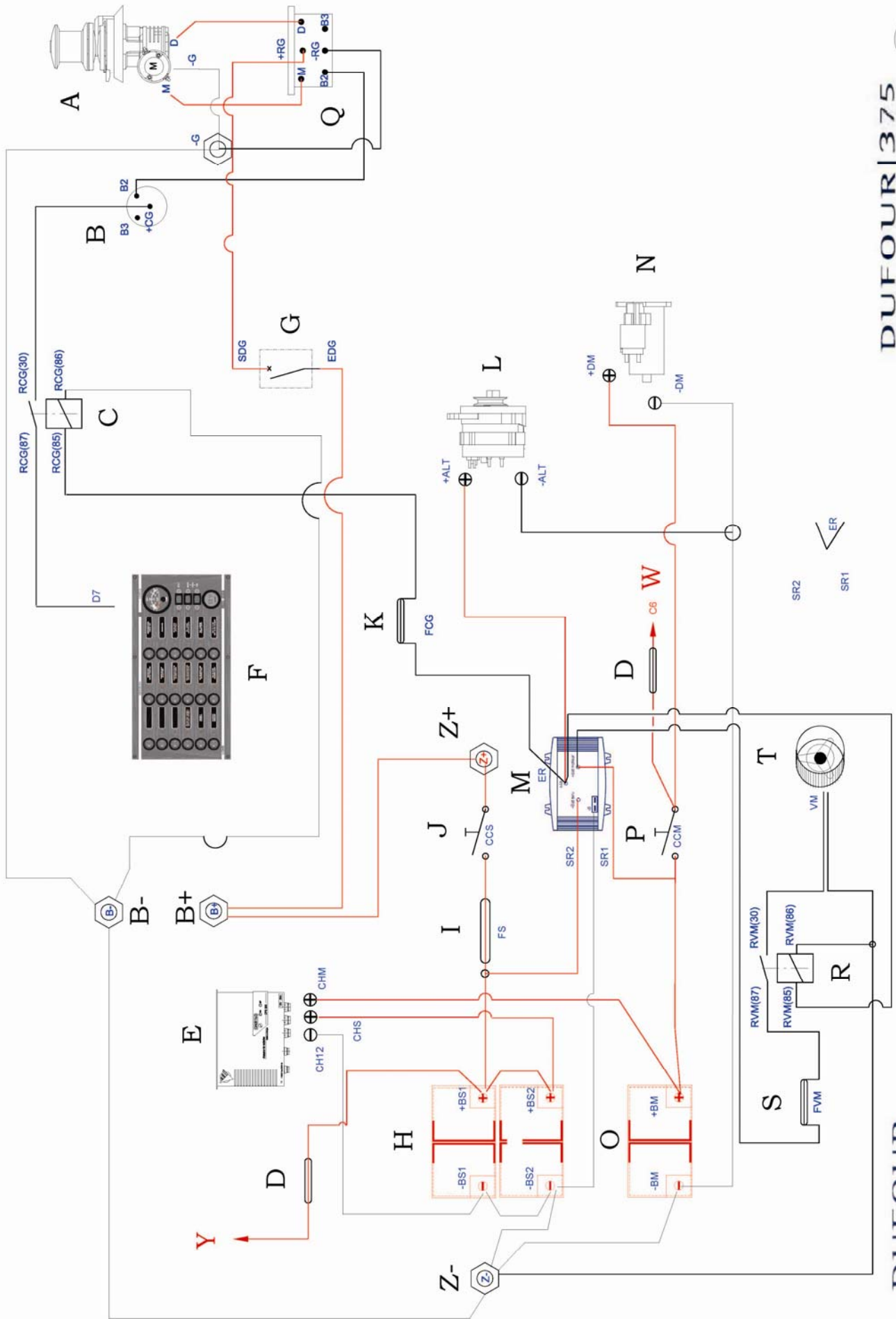

## 8.12 V distribution panel diagram

<i>Label</i>	<i>Description</i>	<i>Protection</i>
	<i>12 V distribution panel</i>	
1	Deck light / Spares 1	10A
2	Miscellaneous 2	10A
3	Windlass	10A
4	Water pump unit	10A
5	Bilge pump	15A
6	Shower pump	10A
7	Navigation lights	10A
8	Mooring light	10A
9	Steaming light	10A
10	Refrigerator	10A
11	Navigation instrument pack	10A
12	Auto pilot	20A
13	Saloon lights	15A
14	Cabins lighting	15A
15	Hifi / 12 V outlet	10A

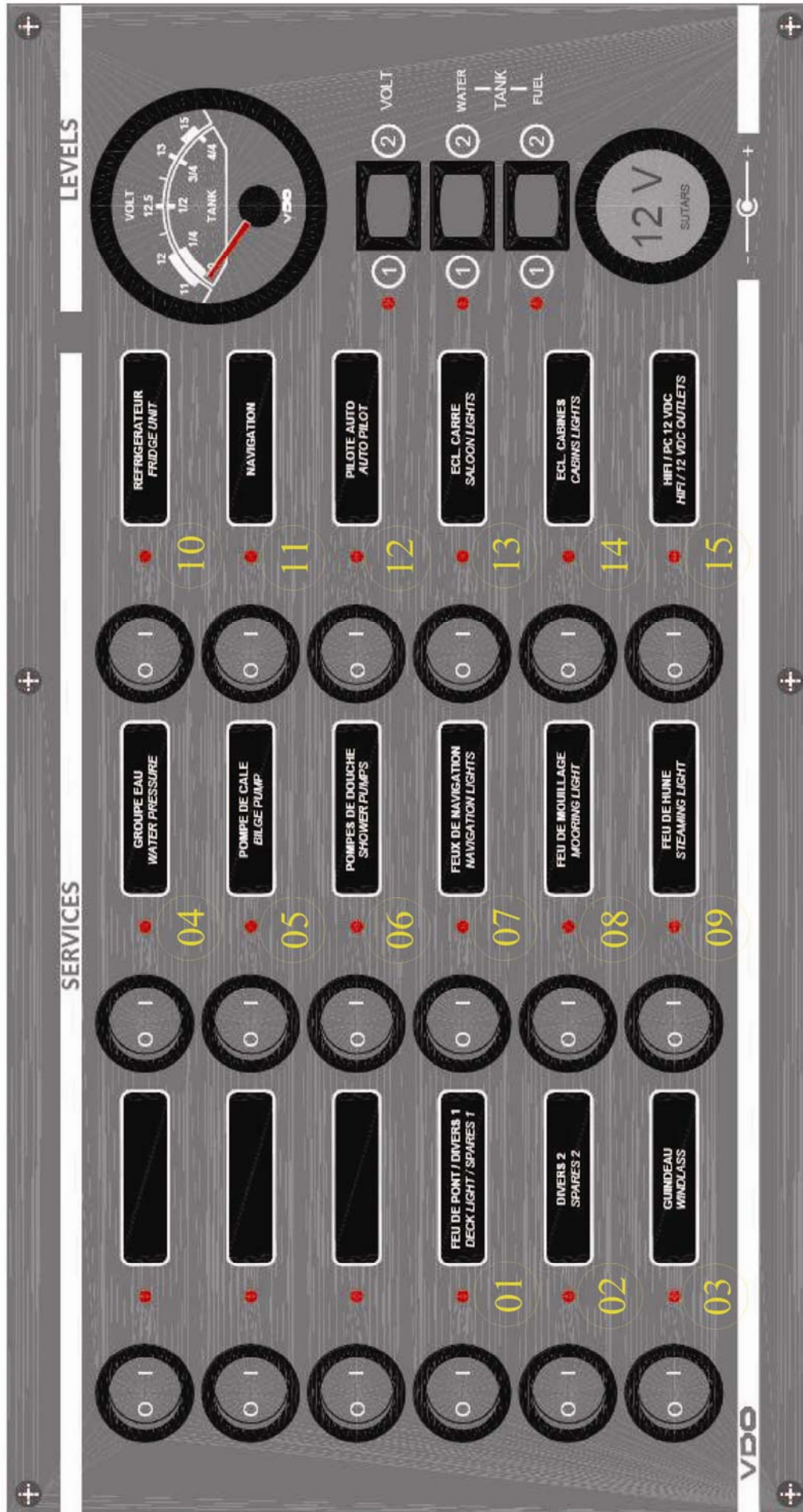

## 9.12 V electrical panel terminal diagram

<i>Label</i>	<i>Description</i>
<b>A</b>	<b>A Connector</b>
1	Water pump unit
2-5	Battery positive
3	Fridge thermostat relay
4	Bilge pump
6	Navigation equipment *
7	Shower drain pump
8	Battery negative
9	Autopilot
<b>B</b>	<b>B connector</b>
1	Navigation lights and compass
2-5	Battery positive
3	Saloon and chart table lights
4	Mooring light
6	Cabin and toilet lights
7	Steaming light*
8	Battery negative
9	HIFI * / 12 V outlet
<b>C</b>	<b>C Connector</b>
6	Engine battery test – T1
1/2/3/4	Fore watertank sensor – D1
9/10/11/12	Aft watertank sensor – D2
5	Fuel gauge sensor - G1
7	Water & fuel at level 0
8	Fuel gauge sensor - G2**
<b>D</b>	<b>D Connector</b>
1	Deck lights ** / Spares 1
2-5	Battery positive
4	Spares 2
7	Windlass control
8	Battery negative
	<i>Electrical wiring colours</i>
<i>n</i>	black
<i>r</i>	red
<i>w</i>	white
<i>o</i>	orange
<i>m</i>	brown
<i>b</i>	blue
*	Option
**	Not supplied

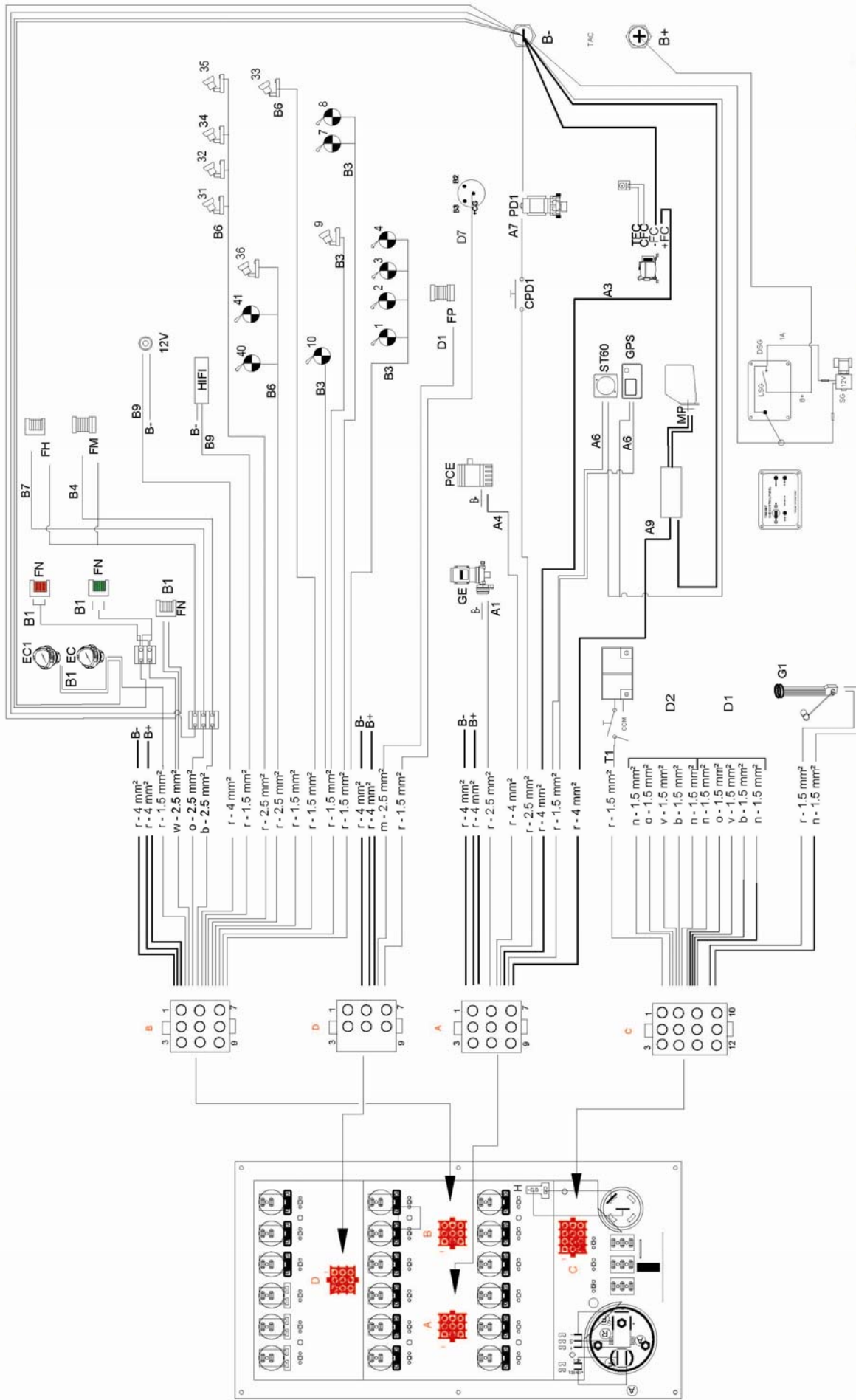

## 10. 12V electrical installation diagram

<i>Label</i>	<i>Description</i>
1	Windlass *
2	Windlass relay*
3	Windlass remote control*
4	25A battery charger*
5	Bulkhead light + switch
6	Fuel gauge
7	Fresh-water gauge
8	Cockpit speaker
9	12V control panel
10	Steering compass
11	Auxiliary fuse
12	Navigation lights
13	Steaming light
14	Mooring light
15	Deck light
16	Solenoid valve *
17	Gas alarm detector panel *
18	Autopilot motor*
19	Shower pump control
20	Refrigeration unit
21	Shower waste pump
22	Bilge pump
23	75 Ah engine battery
24	100 Ah auxiliary batteries (1+1*)
25	Water pump unit
26	Motor fan
27	Chart table reading light
28	Engine and auxiliary battery isolator
29	Splitter
30	Alternator
31	Starter
32	Depth sounder & log transducers *
33	Spot
34	Reading light
35	Saloon loudspeaker
*	Option



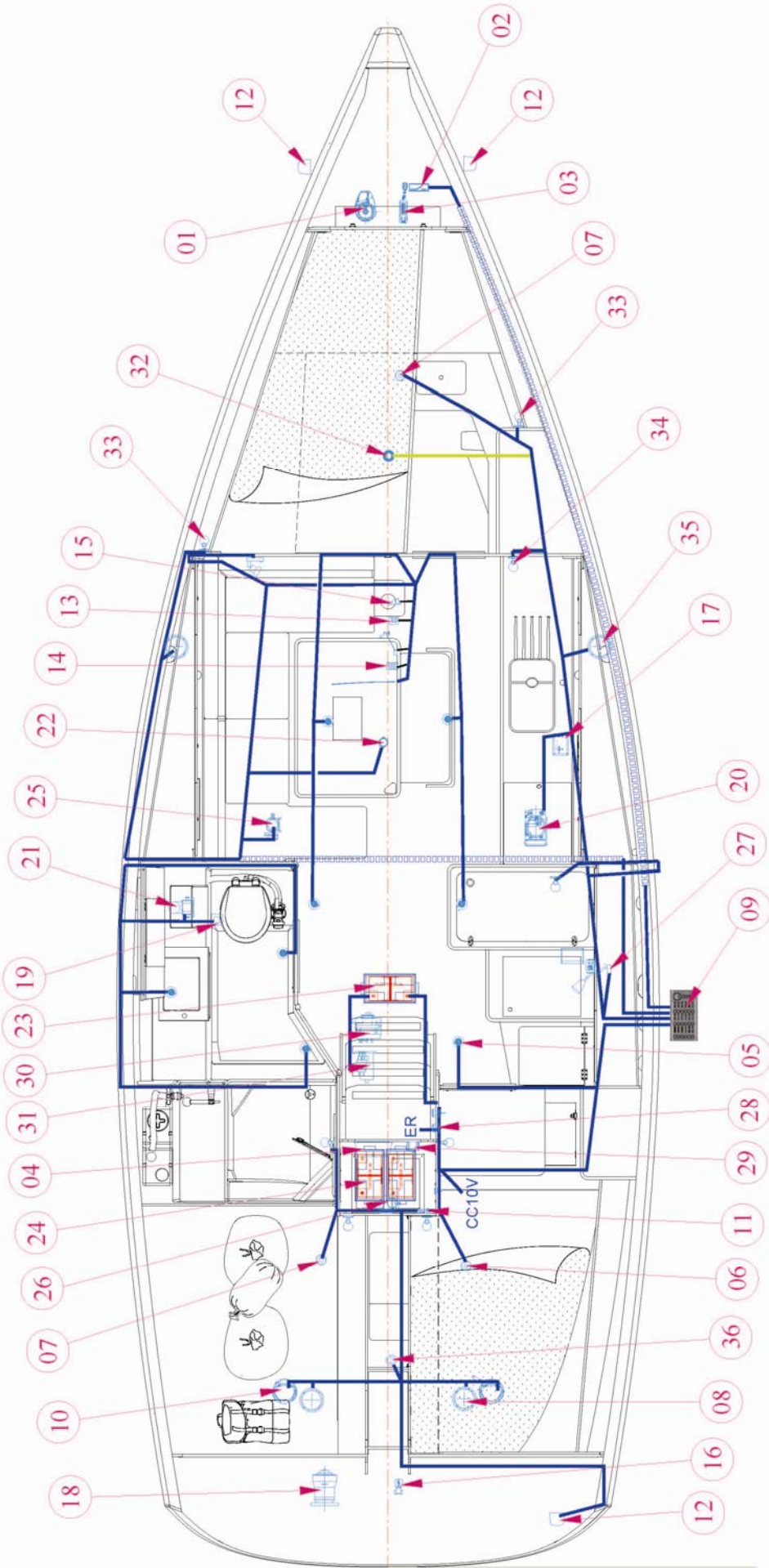

**DUFOUR | 375**  
*Grand'Large*

10

**DUFOUR**  
 YACHTS

## 11. 220 V electrical installation diagram

<i>Label</i>	<i>Description</i>
1	220 V ( or 110V ) outlet *
2	Water heater *
3	Battery charger *
4	Main circuit-breaker box*
5	6-way box with differential circuit-breaker.
*	Option

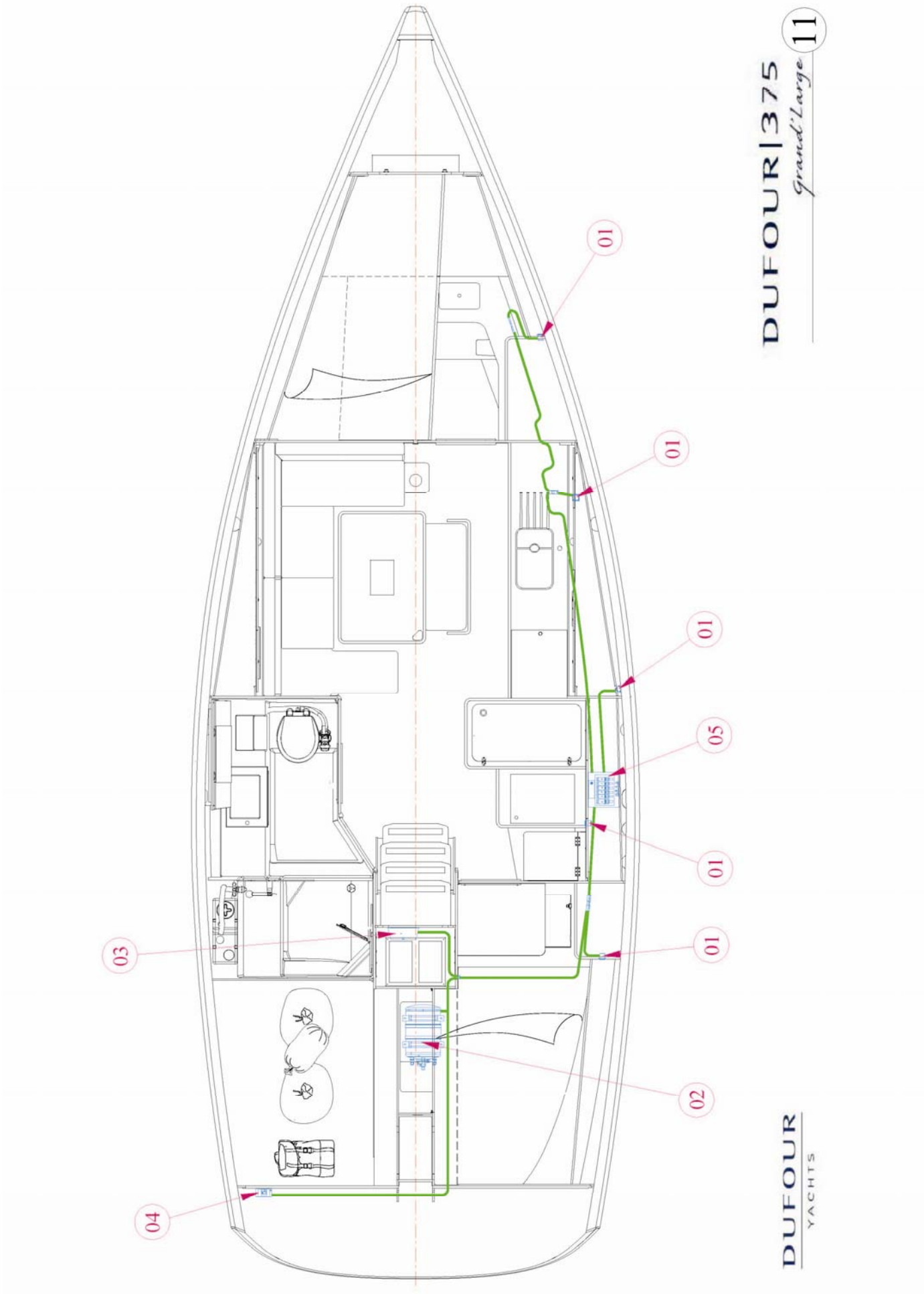

## 12. Steering system diagram

<i>Label</i>	<i>Description</i>
1	Rudder blade
2	Rudder stock
3	Steering column
4	Tiller deck plate
5	Emergency tiller
6	Steering wheel
7	Autopilot*
8	Bulkhead device + brake only on starboard
9	5 mm dia. Cable
10	Pull-Push duct
11	Sleeve terminations and Rudder stop set
12	Quadrant
13	Thrust bearing
14	Rudder trunk
15	Self-aligning upper bearing
*	Option

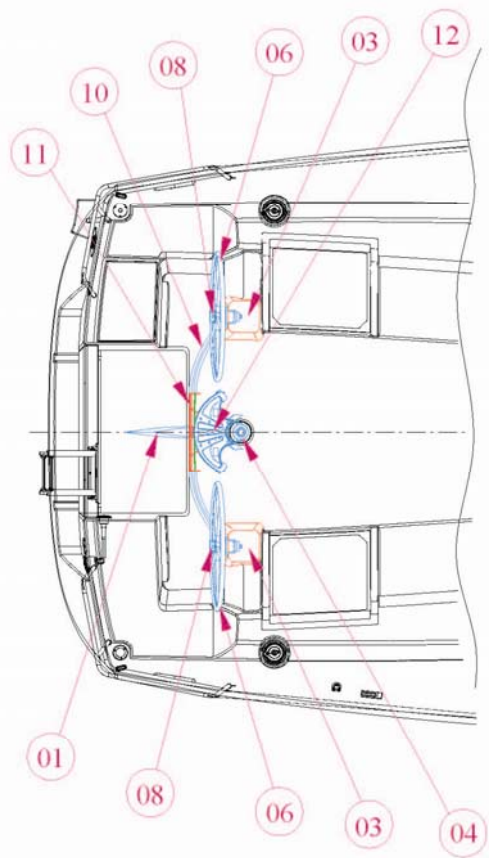
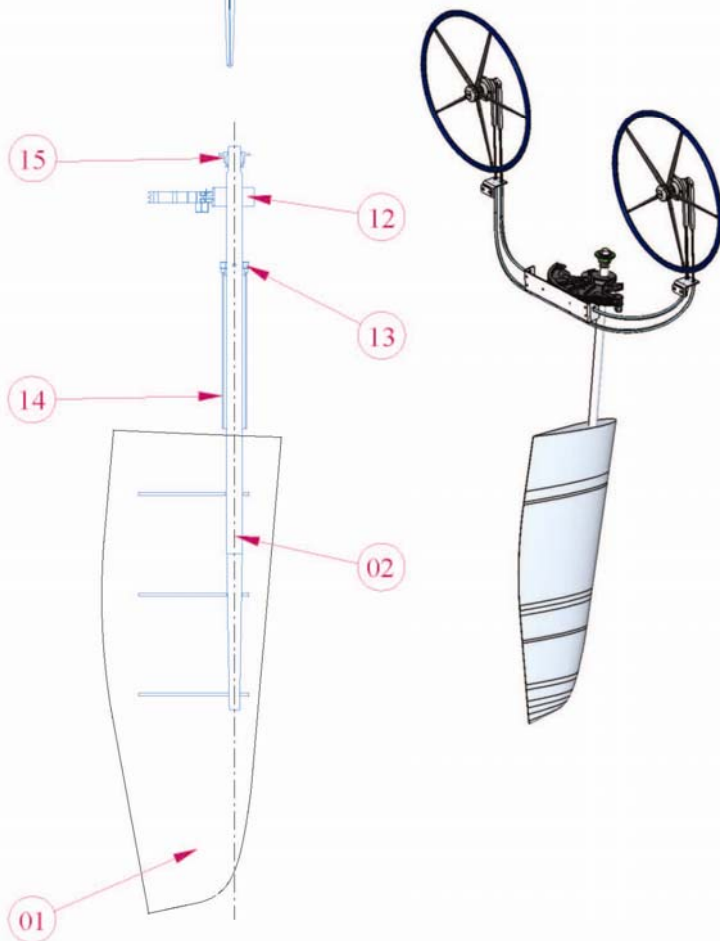
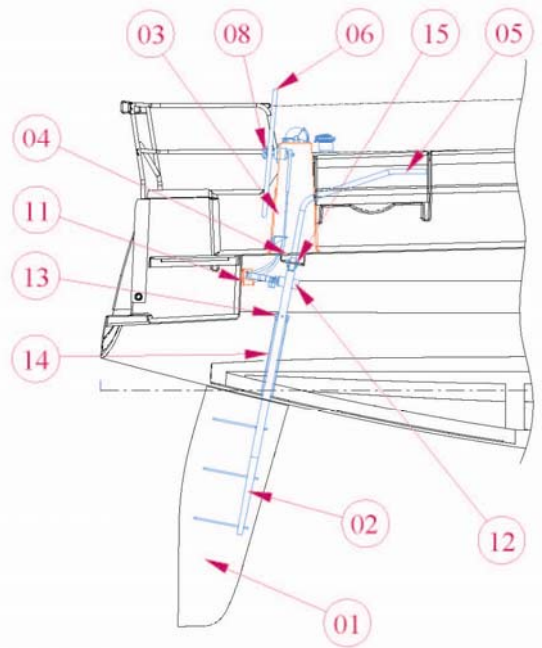
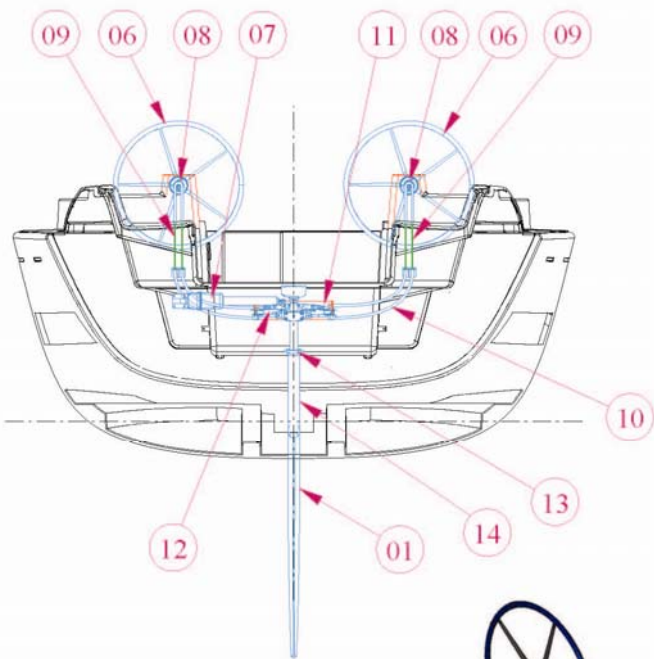

DUFOUR  
YACHTS

DUFOUR|375  
*Grand'Large* 12

### 13. Gas system diagram

<i>Label</i>	<i>Description</i>
1	1.8kg gas cylinder **
2	CE shut-off valve (Fr. or Ger.) **
3	30 mbar CE regulator (Fr. or Ger.) ** / Pressure gauge**
4	Medium-length connecting hose
5	Spacer piece / 6×8 pipe
6	Watertight bulkhead fitting
7	PVC pipe
8	6×8 copper pipe
9	CE gas shut-off valve (in compartment below cooker)
10	Long connection hose
11	2-burner stove / oven
**	Not supplied

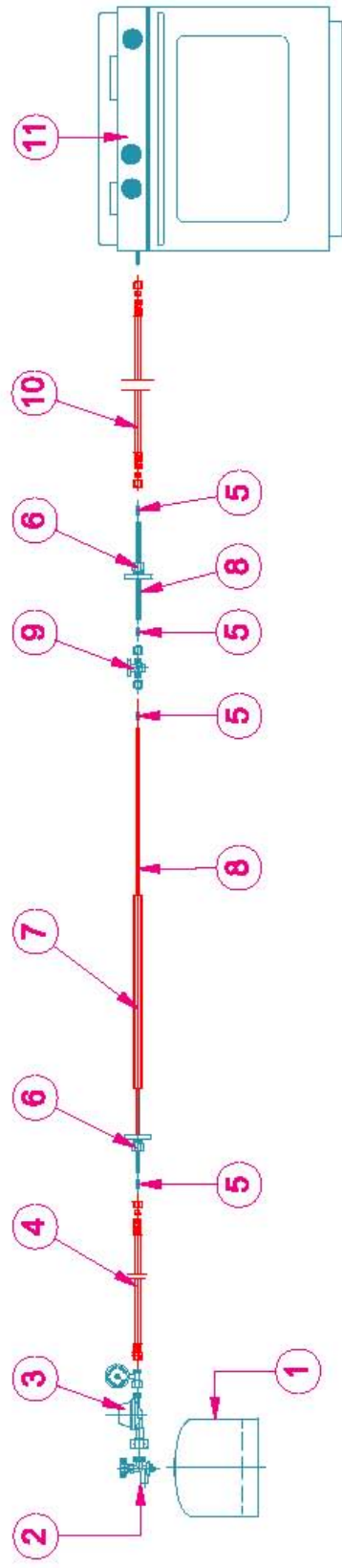
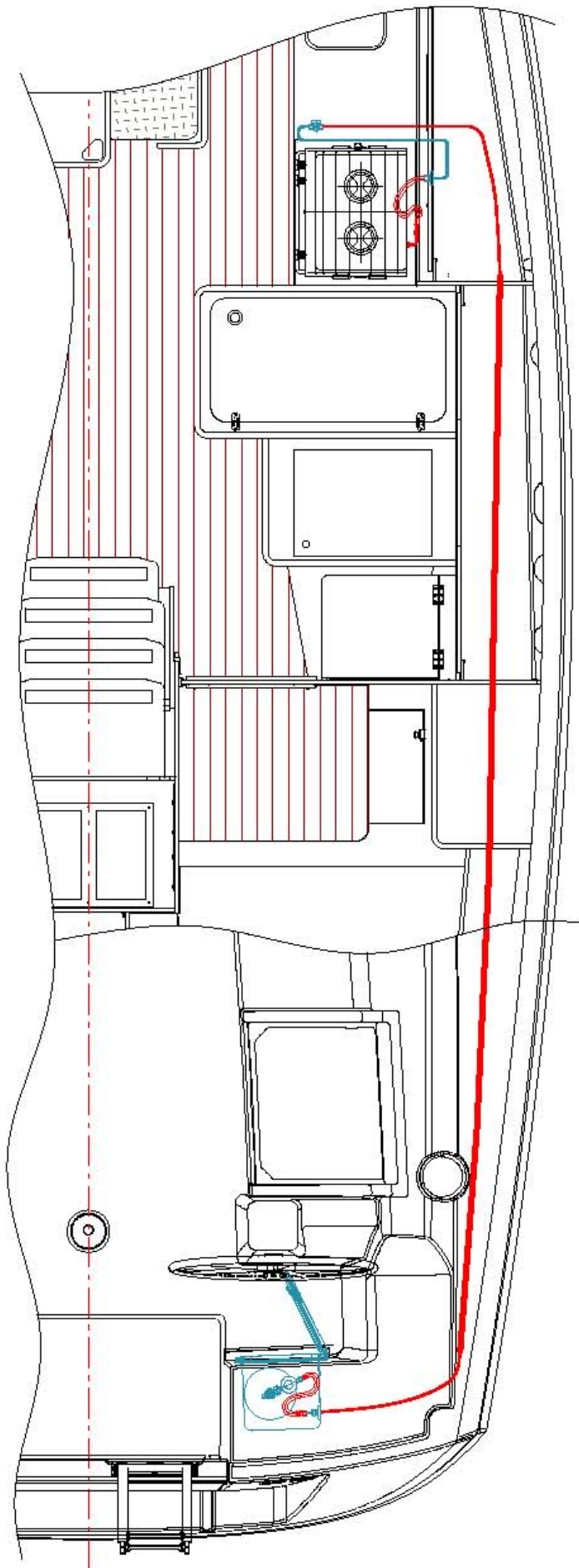

## 14. Abandon ship plan

<i>Label</i>	<i>Description</i>
Ex	Recommended fire-extinguishers locations
1	Under chart table **
2	Under saloon's settee **
WH	Engine compartment extinguishing hole
EXIT	Emergency exit
**	Not supplied



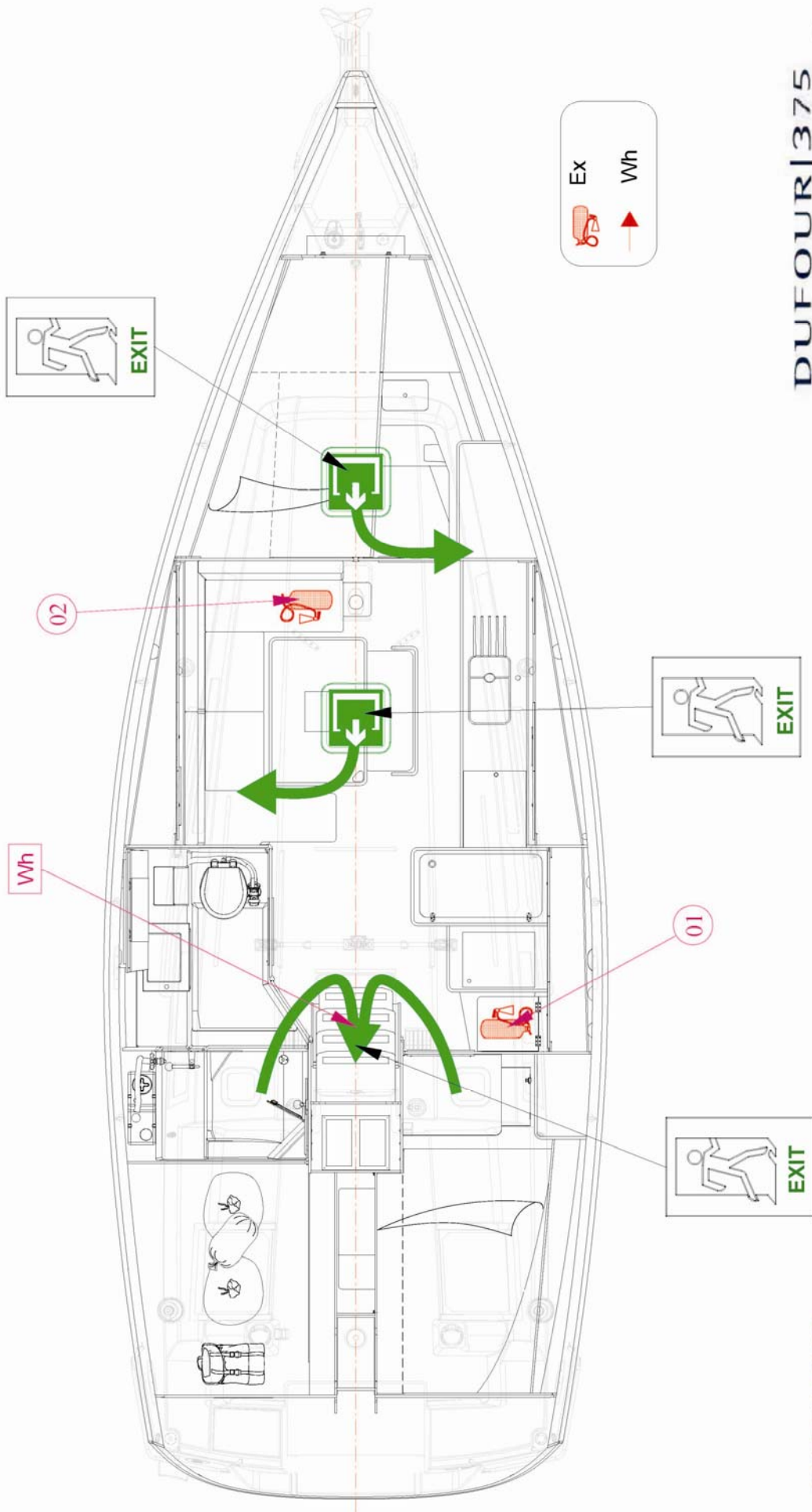

## 15. Fresh-water system diagram

<i>Label</i>	<i>Description</i>
1	Filler deck plate
2	Filler hose
3	Vent
4	Vent hose
5	200 L water tank
6	Cold water pipe
7	1/2" 2-way manifold
8	Water pump unit
9	Fresh-water pump
10	20 L water heater
11	Bathroom mixer tap
12	Galley single-lever mixer tap
13	Deck shower
14	160 L water tank
15	Hot water pipe
16	3/4" Male bolt
17	1/2" 1/4-turn seacock
18	Elbow
19	1/2" WX M connector
20	Single-lever mixer tap + hose
21	Mixer tap/showerhead
*	<a href="#">Option</a>

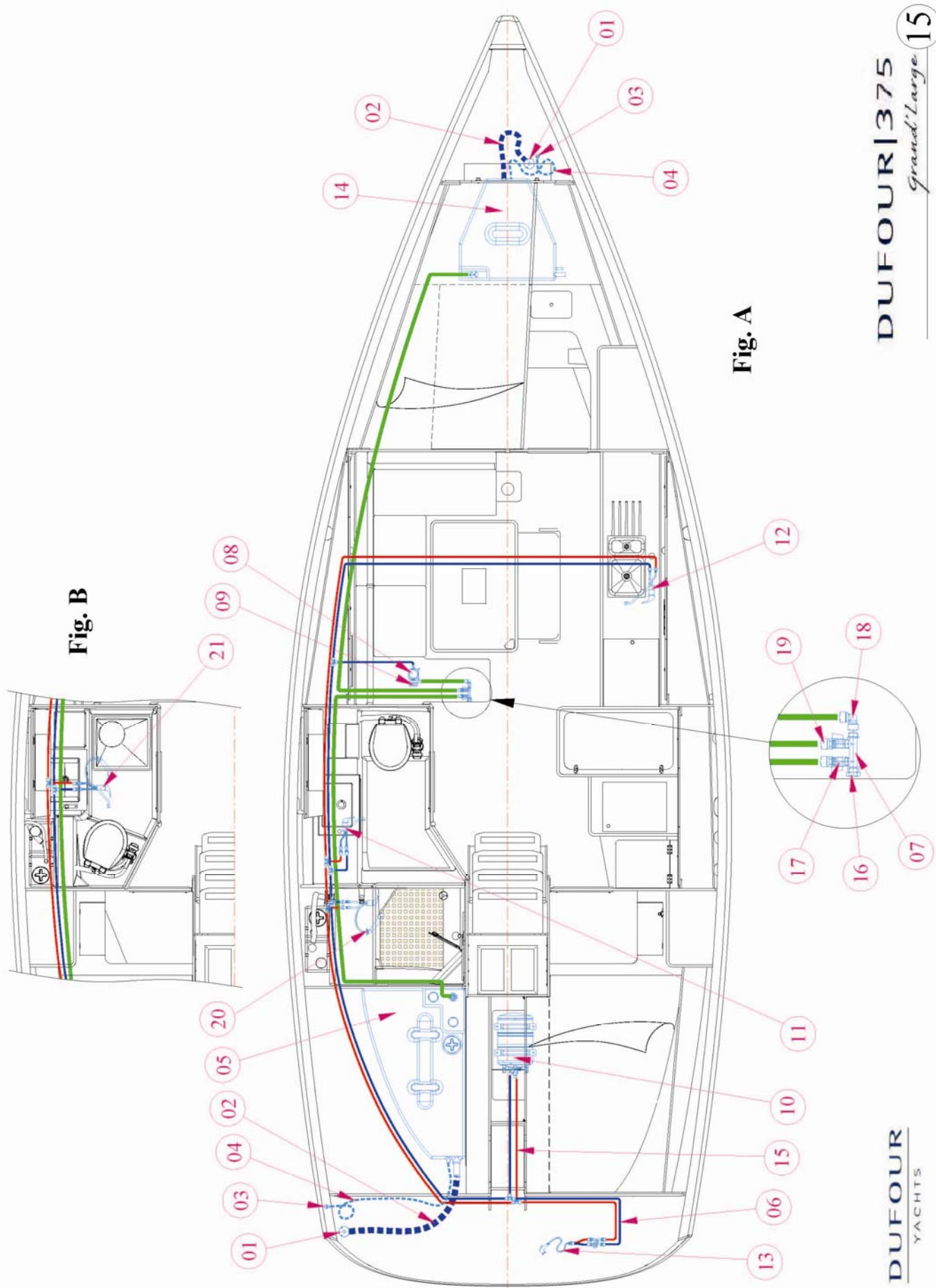
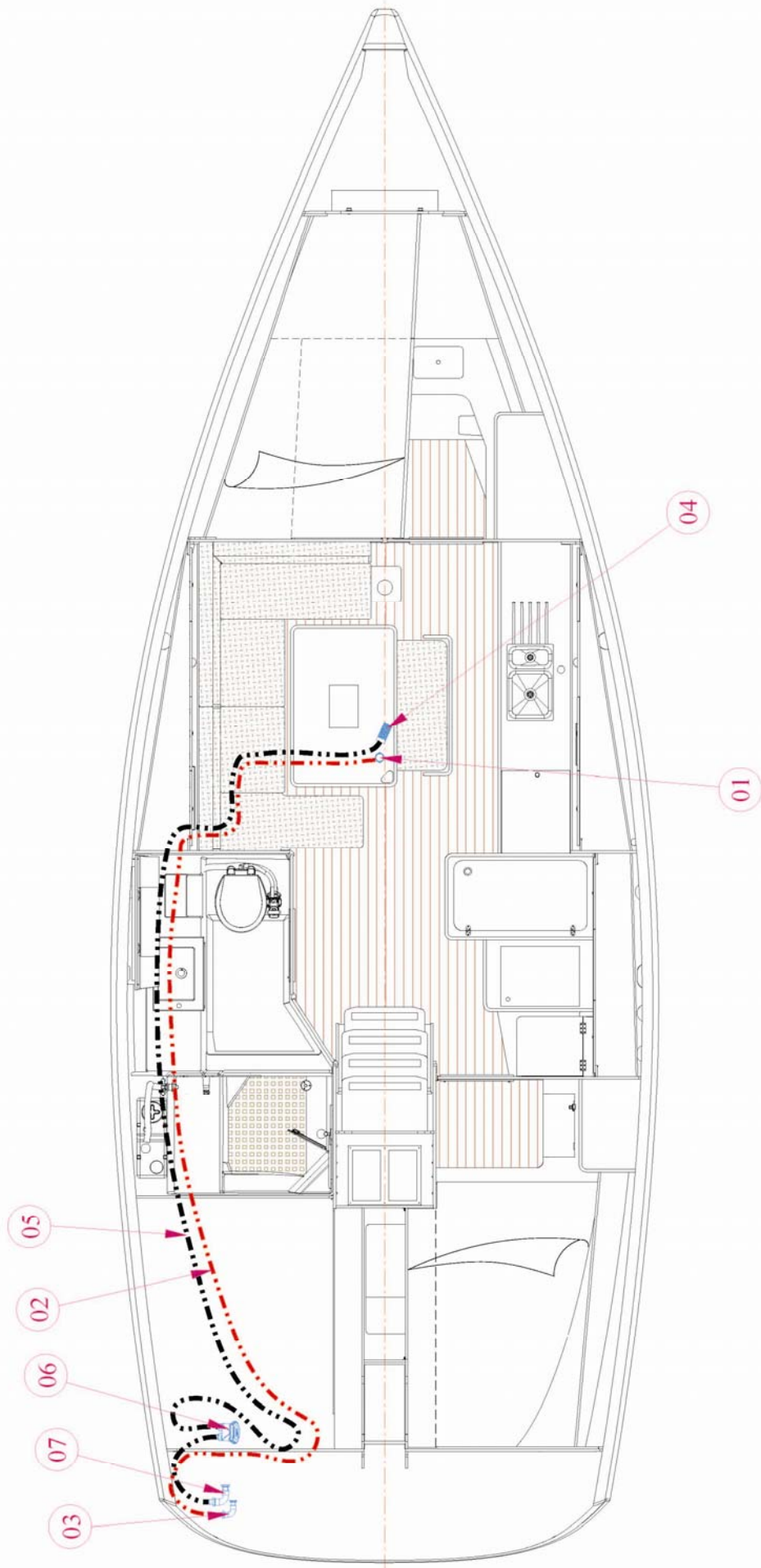

Fig. A

Fig. B

## 16. Drain system diagram

<i>Label</i>	<i>Description</i>
	<b><i>Electric bilge pump</i></b>
1	Electric bilge pump
2	Ø20 discharge hose
3	Skin fitting
	<b><i>Manual bilge pump</i></b>
4	Strainer
5	Ø25 discharge hose
6	Manual bilge pump
7	Skin fitting



## 17. Skin fitting location diagram

<i>Label</i>	<i>Operations</i>	<i>Ø</i>
	<b><i>Skin fitting &amp; seacock</i></b>	
1	Galley sink discharge	1"
2	Washbasin discharge	1"
3	Toilet sea-water intake	3/4"
4	Toilet discharge	2"
5	Shower waste	3/4"
6	Foot pump sea water intake*	1/2"
	<b><i>Skin-fitting</i></b>	
7	Electrical bilge pump discharge	3/4"
8	Manual bilge pump discharge	1"
*	Option	

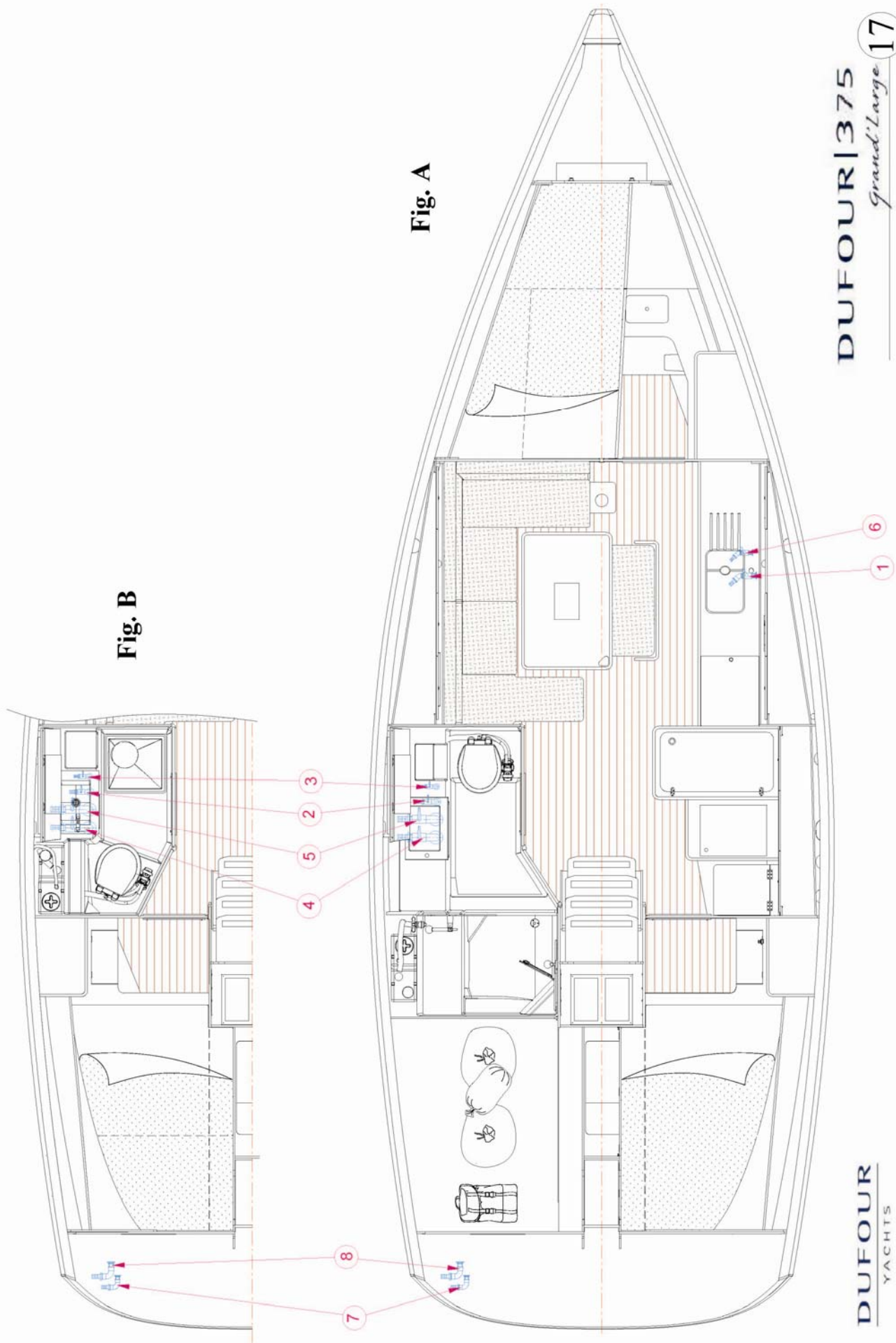

## 18. Engine installation drawing

<i>Label</i>	<i>Description</i>
	<b><i>General</i></b>
1	Engine
2	Sail-drive
3	Engine sea-water pump
4	Polyester frame
5	Isolator
6	Propeller
7	Anode
	<b><i>Cooling system / Exhaust system</i></b>
8	Raw water inlet
9	Exhaust pipe
10	Exhaust outlet
11	Anti-siphon elbow
12	Vetus LBS Silencer
	<b><i>Fuel system</i></b>
13	Diesel filter with water separator
14	Splash stop*
15	Fuel filler deck plate
16	Filler hose
17	Fuel tank vent
18	Fuel tank hose
19	200 L Fuel tank
20	Fuel shut-off valve
21	Fuel feed hose
22	Fuel return hose
	<b><i>Ventilation</i></b>
23	Bilge fan
24	Ventilation grilles
25	Ventilation duct
	<b><i>Miscellaneous</i></b>
26	Engine controls
27	Control cables
28	Engine battery
*	Option



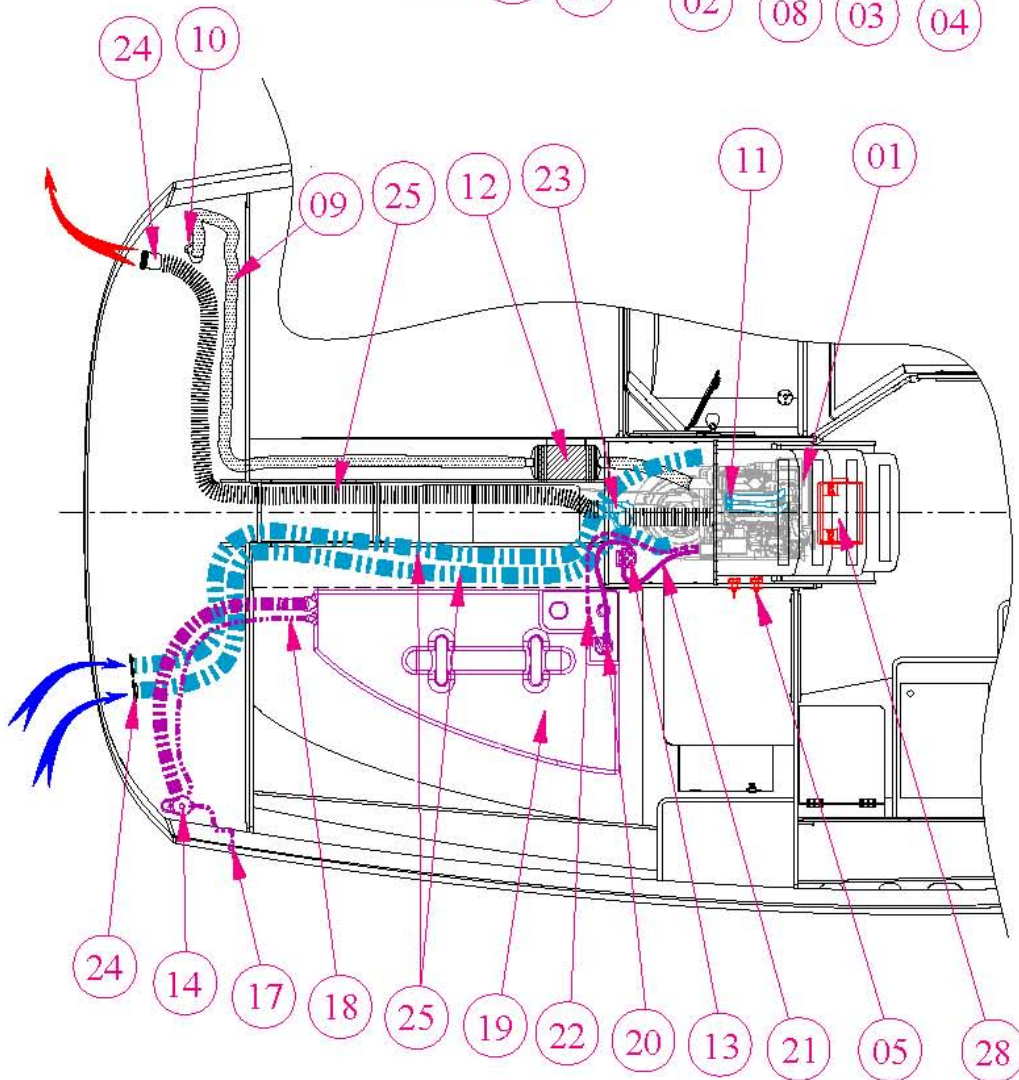
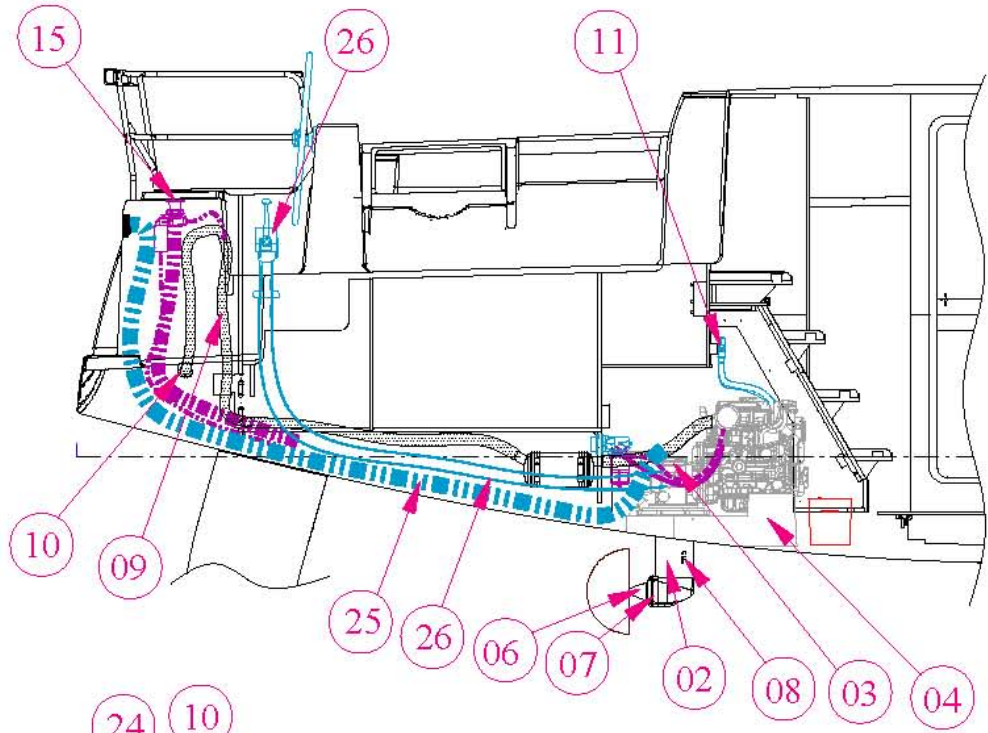

## **19. Holding tank installation diagram**

<i>Label</i>	<i>Description</i>
1	Skin fitting & seacock, ¾"
2	Ø 50 mm waste deck plate
3	Skin fitting & seacock, 2"
4	20 mm Ø hose
5	38 mm Ø anti-odour hose
6	51 D anti-odor hose
7	Chromed brass vent
8	Aft 50 L polythene holding tank
X	U-bend

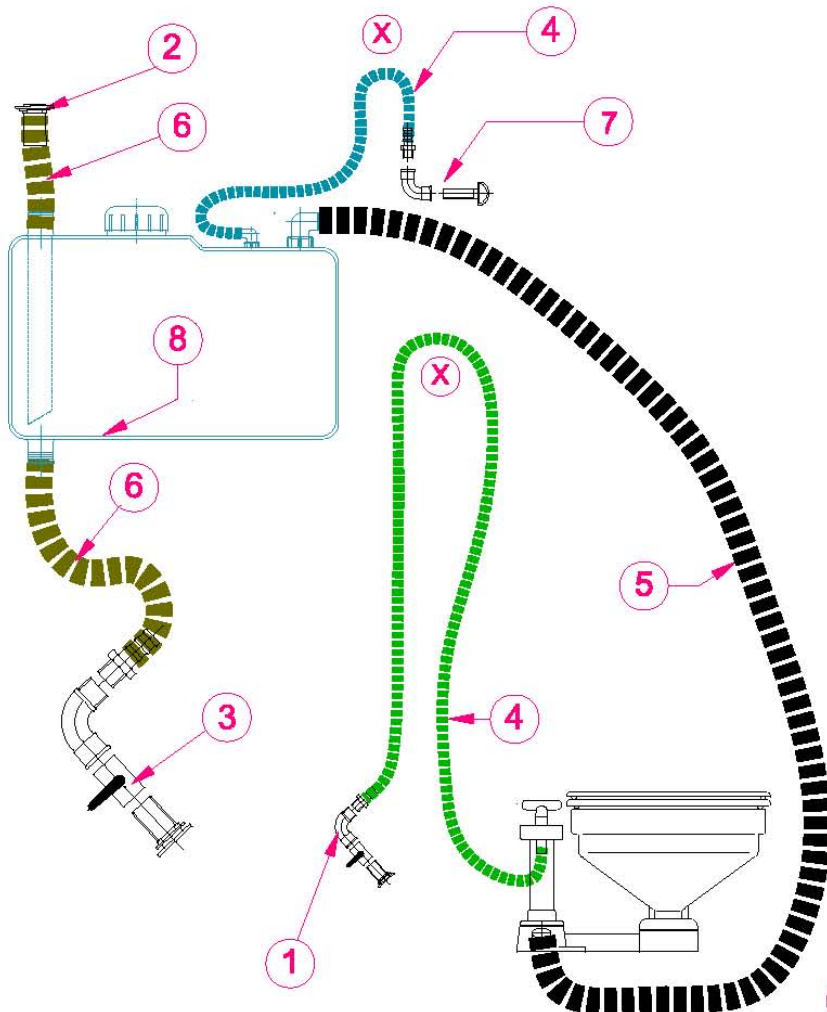

**Fig. A**

**Fig. B**

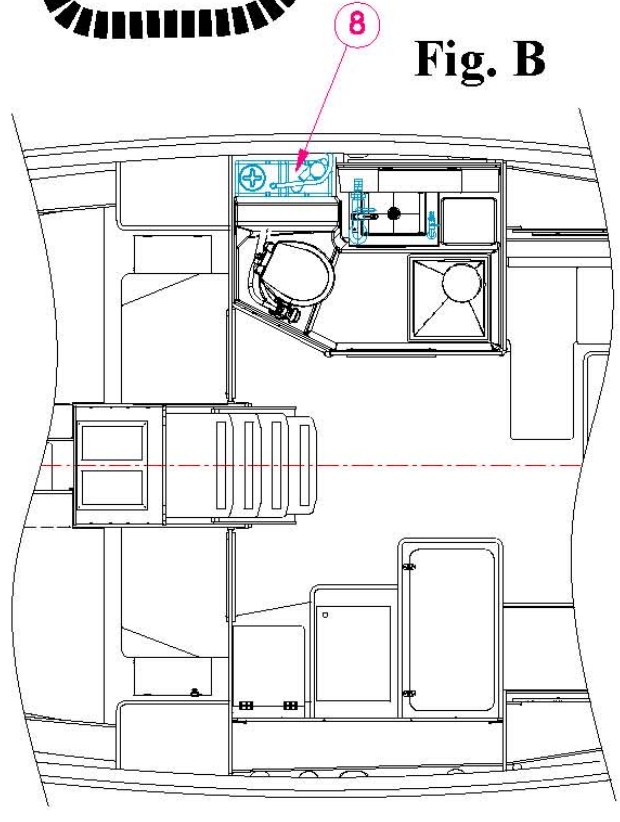
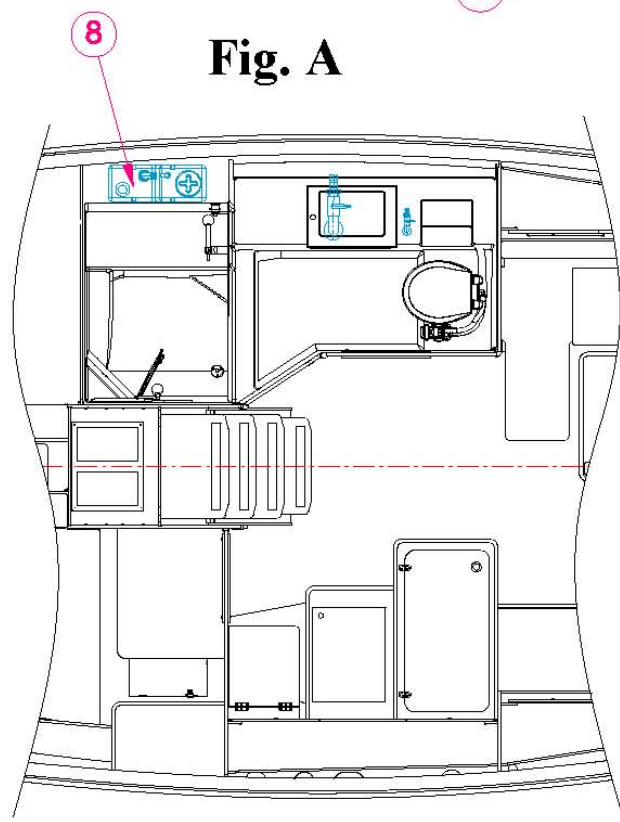

## 20. Lifting diagram

<i>Label</i>	<i>Description</i>
	See red triangular marker under deck-line
	Light displacement:
	- short keel 7,160 kg
	- long keel 7,060 kg
	Max. beam 3.85 m
	Shallow draught: 1.60 m
	Deep draught: 1.90 m

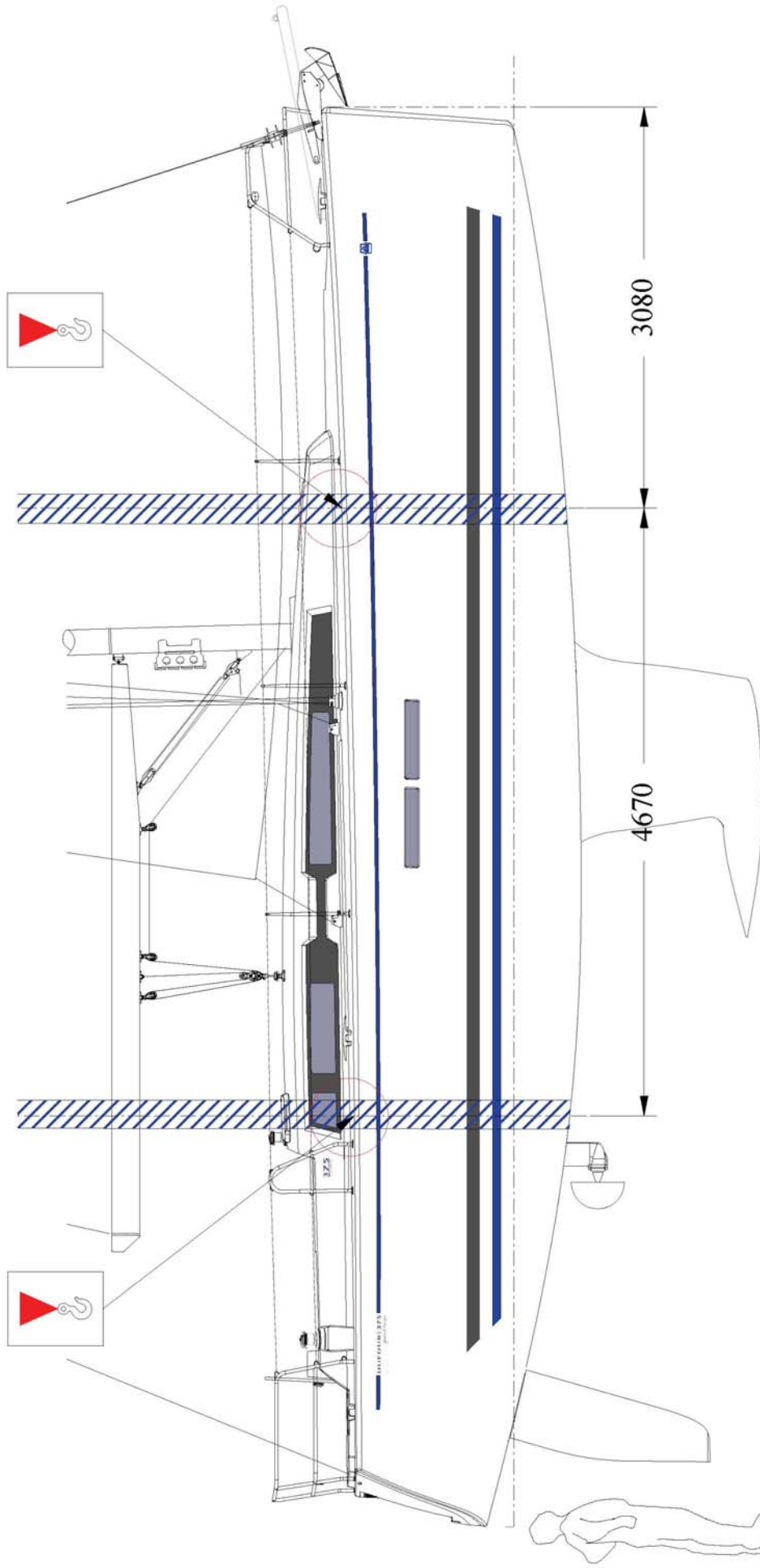

**DUFOUR | 375**  
*Grand'Large* **20**

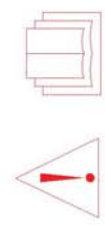

**DUFOUR**  
 YACHTS

**NOTES**