



DUFOUR
YACHTS

BESITZERHANDBUCH



This page intentionally left blank.

This page intentionally left blank.

This page intentionally left blank.

Your contact:

Name

is the representative for **DUFOUR YACHTS** and will provide you with all the help necessary to solve any problems which you might have at the time of launch and masting, as well as for the start-up and maintenance inspections for your boat. If necessary, they will help you with the administrative process of registering your boat.

As soon as you become the owner, familiarise yourself with the manual supplied with your boat, sign and date the receipt acknowledgements below, and give (or send) the last one to your agent.

Owner's Manual receipt acknowledgement to be kept in your Manual

I, the undersigned:

Name

Address

owner of the **DUFOUR 335** n°

confirms having received the Owner's manual of the **DUFOUR 335** and having accepted it in English.

Dated:

Signature:

Detach along dotted line



Owner's Manual receipt acknowledgement to be returned to DUFOUR YACHTS

1, Rue Blaise Pascal- 17187 PERIGNY CEDEX- FRANCE

I, the undersigned:

Name

Address

owner of the **DUFOUR 335** n°

confirms having received the Owner's manual of the **DUFOUR 335** and having accepted it in English.

Dated:

Signature:

This page intentionally left blank.

This page intentionally left blank.

This page intentionally left blank.

CONTENTS

INTRODUCTION	7
I. GENERAL INFORMATION	8
Design category	8
Certification	8
Identification	8
Builder's plate	9
Degrees of danger	9
II. PRINCIPAL SPECIFICATIONS	10
III. ELECTRICAL SYSTEMS	11
Safety and operating instructions for the electrical system	11
Installing new equipment	11
Batteries	12
Electric windlass	12
220 Volts /110 Volts installation (ISO 13297: 2000)	13
IV. GAS INSTALLATION	14
Operating advice	14
Checking the gas circuit (ISO 10239: 2000)	15
Changing the gas cylinder	15
V. DRAIN & SANITATION SYSTEM	16
Characteristic of the exhaust system (ISO 15083: 2003)	16
Pressurized fresh-water pump	16
Seacocks	18
Operation of sea toilets	18
Operation of the holding tank (ISO 8099: 2000)	18
VI. FLOODING	19
VII. FIRE PROTECTION	19
Installation	19
Safety instructions	20
VIII. ENGINE	21
General precautions	21
Exhaust gas emission	21
Safety 21	21
Wintering	23
IX. FUEL INSTALLATION	23
X. STEERING SYSTEM	23
Helm 23	23
Emergency tiller	24
XI. SAILING	24
XII. PROTECTION AGAINST LIGHTNING	25
Maintenance	25
Protection of persons during a storm	25
XIII. ENVIRONMENTAL PROTECTION & SAFETY	25
XIV. SAFETY FACILITIES	26
XV. HANDLING, TRANSPORTING, HAULOUT	26
XVI. GUARANTEE, TRANSFER OF OWNERSHIP	29
1. Presentation plan.....	34
2. Accommodation layout	35
3. Deck fittings plan.....	37
4. Sail plan	39
5. Halyard and sheet operating diagram.....	41
6. 220 V circuit diagram	43
7. 220 V electrical installation diagram	45

8.	<i>Fuse location diagram</i>	47
9.	<i>Charging and power system diagram</i>	49
10.	<i>12 V distribution panel diagram</i>	51
11.	<i>Terminal block diagram</i>	53
12.	<i>12 V electrical installation diagram</i>	55
13.	<i>Rudder system diagram</i>	57
14.	<i>Gas system diagram</i>	59
15.	<i>Abandon ship plan</i>	61
16.	<i>Fresh-water system diagram</i>	63
17.	<i>Drain system diagram</i>	65
18.	<i>Skin fitting location diagram</i>	67
19.	<i>Mechanical installation diagram</i>	69
20.	<i>Holding tank installation diagram</i>	71
21.	<i>Lifting diagram</i>	73

INTRODUCTION

DUFOUR YACHTS is pleased to present you with this manual which will help you to get to know your boat better.

This Manual has been produced to help you use your boat safely and enjoyably. It contains details of the boat, the equipment supplied or fitted, its systems and information about their use. Read it carefully and familiarize yourself with the boat before using it.

This Owner's Manual is not a course in sailing safety or seamanship. If this is your first boat, or you are changing to a type of boat you are unfamiliar with, for your convenience and safety, make sure you gain experience handling and using it before taking command. Your agent, your national sailing or cruising federation or your yacht club will be happy to give you information about sailing schools or qualified instructors in your area.

Ensure that forecast wind and sea conditions correspond to the design category of your boat, and that you and your crew are capable of handling the boat in these conditions. Even when your boat is suitable for them, the sea and wind conditions corresponding to design categories A, B, and C vary from severe storm for category A to severe conditions for the top end of category C, subject to dangers of abnormal gusts or waves; these are dangerous conditions in which only an experienced, trained crew in good condition, sailing a properly-maintained boat, can sail in a satisfactory manner.

This Owner's Manual is not a detailed maintenance or repair guide. In the event of problems, consult the boat builder or their representative. If a maintenance manual is provided, be sure to use it.

Always employ the services of an experienced professional for maintenance, fitting accessories, or modifications. Modifications that could affect the characteristics of the boat must be assessed, performed and documented by qualified personnel. The boat builder cannot be held responsible for modifications made without their approval.

In certain countries, a skipper's license or authorization are required, or special regulations are in force.

Always maintain your boat correctly and make allowance for deterioration due to age or resulting, where applicable, from heavy or unsuitable use. Any boat, however sturdy it is, can be severely damaged if it is used incorrectly. This is incompatible with safe sailing. Always suit your speed and heading to the prevailing sea conditions.

If your boat is equipped with a life-raft, read its instruction manual carefully. The crew must have on board all the safety equipment (life-jackets, harnesses, etc.) corresponding to the type of boat, weather conditions, etc. In some countries, this equipment is mandatory. The crew must be familiarized with the use of all the safety equipment and with emergency safety procedures (man overboard recovery, towing, etc.); training sessions are regularly organized by sailing schools and clubs.

It is recommended that all persons wear appropriate buoyancy aids (life-jackets, personal flotation devices) when on deck. It should be noted that in certain countries, it is compulsory to wear a buoyancy aid (complying with national regulations) at all times.

KEEP THIS MANUAL IN A SAFE PLACE AND PASS IT ON TO THE NEW OWNER IF YOU SELL THE BOAT.

WARNING: *Our boats are regularly improved in the light of our customers' experiences and researched by the shipyard, and so the specifications given in this Owner's Manual are not contractually binding and may be changed without notice and without any obligation to update. This manual is intended to cover as much information as possible, so certain equipment or paragraphs might not apply to your boat. In case of doubt, please refer to the inventory which should have been given to you by your agent when you placed your order.*

I. GENERAL INFORMATION

Design category

Your **DUFOUR 335** is in the **OCEAN-GOING** category (category A).

Under normal conditions of use, your boat is designed to sail in waves significantly higher than 4 m and winds of force 8 or higher on the Beaufort scale, and to withstand even more severe conditions.

This sailing capability is equally dependent on the skills of the crew, their physical capacities, the maintenance of the boat and its equipment.

So always take care before putting to sea.

DUFOUR YACHTS cannot guarantee the perfect operation of the boat in exceptional sea conditions (violent storms, hurricanes, cyclones, waterspouts, etc)

SUMMARY OF DESIGN CATEGORIES

Design category	Type of sailing	Wind strength (Beaufort)	Wind speed	Effective wave height to be taken into account
A	Ocean-going	Superior to 8	Up to 28 m/s	Higher than 4 m
B	Open sea	Up to and including Force 8	Up to 21m/s	Up to and including 4 m
C	Inshore	Up to and including Force 6	Up to 17 m/s	Up to and including 2 m
D	In sheltered waters	Up to and including Force 4	Up to 13 m/s	Up to and including 0.5 m

Always check the weather forecast before taking to sea: **take to the sea, don't take risks!**

In port: every day, the harbour office posts weather bulletins and forecasts for the coming days.

Météo France on 0836 68 08 08

Navifax - direct on 0836 70 18 52

VHF: CROSS transmit several bulletins per day, preceded by an announcement on Channel 16.

Certification

DUFOUR YACHTS has chosen the French Institute for Certification and Standardisation (icnn.fr) for Water sports as the approved body to ensure the conformity of your boat with the European Directive EC 94/25, module B.

Identification

The hull identification number is located on starboard side of transom. It contains a series of letters and numbers that begin with FR-DUF...

Builder's plate



Part of this information is given on the builder's plate attached to the boat. A full explanation of this information is given in the chapter that follows.

Design category = A

: Ocean-going (see 1.1)

Maximum number of people:

: recommended by the builder for navigation in sea conditions for category for which it was built.



category A = 6
category B = 8
category C = 10
category D = 10

WARNING

Do not exceed the maximum recommended number of people. However many people there are aboard, the total weight of the people and equipment must never exceed the maximum recommended loading.

Maximum load recommended:

: recommended by the manufacturer including the weight of all persons aboard, provisions and personal belongings, and all equipment not included in the boat's light displacement, excluding the contents of the tanks.



category A = 1250 kg
category B = 1410 kg
category C = 1480 kg
category D = 1430 kg

WARNING

When loading the boat, never exceed the recommended maximum load. Always load the boat carefully and distribute the weight in a suitable manner in order to maintain the theoretical trim (approximately horizontal). Avoid placing heavy loads high up.

CE 0607

: CE mark indicating that the boat complies with all the requirements of the Directive. : The sequence of numbers is the Certification institution's code. In this case, ICNN (Institut pour la Certification et la Normalisation dans le Nautisme), (refer also to: Safety Compliance Declaration)

Degrees of danger

DANGER	Indicates an extreme intrinsic risk that presents a high probability of death or permanent injury if proper precautions are not taken.
WARNING	Indicates a risk that presents a high probability of death or permanent injury if proper precautions are not taken.
NOTE	Indicates a reminder of safety practices or draws attention to dangerous practices that could result in personal injury or damage to the boat, its components or the environment.

II. PRINCIPAL SPECIFICATIONS

	Model:	DUFOUR 335 Grand Large
	Designer:	Umberto Felci
	Interior design	DUFOUR Design
	Design category	A
	Notified body no.	CE/0607
	Engine #	
L _{max}	Overall length	10.28 m
L _H	Hull length	9.99 m
B _{max}	Maximum beam	3.54 m
B _H	Hull beam	3.54 m
H _A	Max clearance	14.70 m
	Standard mainsail area (approximately)	30 m ²
	Genoa area (approximate)	25 m ²
	Water capacity except water-heater of 20 L (approximately)	200 L + 160 L (option)
	Diesel capacity (approximate)	160 L
	Holding tank	45 L
	Engine battery	75 Ah
	Auxiliary battery (1 standard version + 1 option)	75 Ah + 75 Ah (option)
	Primary means of propulsion	Sail
	Maximum permissible on-board engine power	30 CV/21 kw
	Total weight of liquids (all tanks full)	310 kg
<i>Standard long ballast version</i>		
T	Draught	1.90 m
	Weight of long ballast	1550 kg
m _{LCC}	Light displacement	5674 kg
<i>Short ballast version (option)</i>		
T	Draught	1.55 m
	Weight of short ballast	1650 kg
m _{LCC}	Light displacement	5724 kg

Nota bene: due to the trim and loading of the boat, it is usually not possible to use the entire various tank capacities for freshwater and diesel. You are recommended to maintain a diesel reserve of 20%.

This boat was evaluated using the stability index (STIX), the complete safety measurement concerning the stability, which considers the effects the length of the boat, its displacement, the proportions of the hull, the stability characteristics (recommended maximum load, all the fluids at maximum capacity of tanks, light conditions and standard equipment installed on board; see manufacturer plate and tables above) as well as resistance to flooding. The maximum total load is the sum of the recommended maximum load and the total mass of various liquids (see ISO 12217-2: 2002)

The second index (AVS) represents the angle of vanishing stability in degrees.

	Long ballast		Short ballast	
	Minimum conditions (M _{mo})	Loading conditions (M _{ldc})	Minimum conditions (M _{mo})	Loading conditions (M _{ldc})
STIX	35,23	33,40	33,75	32,10
AVS	126,6°	120,3°	124,7°	118,5°

III. ELECTRICAL SYSTEMS

Safety and operating instructions for the electrical system

WARNING

Improper use of the DC and/or AC systems may give rise to fire or explosion hazards.
Improper use of the AC systems may give rise to electric shock hazards.

Always:

- Check the condition of the batteries (load and level of the electrolyte) and of the charging system before taking the sea.
- Disconnect and remove the batteries for wintering.
- Keep the voltage of the batteries at more than 10.5 V during wintering.
- Always carry spare bulbs for all the navigation lights and interior lighting. Respect power ratings, particularly for navigation lights.
- Check the operation of the navigation instruments.
- Check the operation of the navigation lights before night sailing.

Never:

- Work on a live electric installation.
- Make changes to an installation and relevant diagrams, except if this is done by an electrician qualified in marine electricity.
- Change or modify the circuit breaking capacity of overcurrent protection devices.
- Replace the electrical apparatuses or equipment by components exceeding the rated capacity without upgrading wiring and protection.
- Leave the ship unattended when the electric installation is live, possibly except for an automatic bilge pump and fire and theft protection circuits.

If a fuse or circuit-breaker blows continually, you should consult a specialist to determine the cause of the short-circuit.

Installing new equipment

Since January 1st 1996, the electric components are subject to the European directive on electromagnetic compatibility" (ref. 89/336/EEC). So new equipment being installed must meet this standard and bear the CE mark. Equipment must also be supplied with a compliance certificate and instructions for use.

In the case of 220 or 110 V installations, use only double-insulated or earthed equipment. When such equipment is being installed, respect the fitting instructions (conductor size, protection).

To avoid maintenance problems, be sure to mark in the manual any modifications that may be made to the electrical circuit diagram.

Batteries

The battery group consists of an auxiliary battery of 75 Ah as standard (and one optional 75 Ah battery) and a 75 Ah battery for the starting the engine.

Their capacities have been designed to handle the power requirements of the on-board accessories. To avoid any problems, it is necessary to keep a close eye on the maintenance and correct charging of the batteries.

ATTENTION!

- When installing new electrical appliances, ensure that the total consumption of this equipment remains within the capacity of the batteries.
- Always disconnect the "-" terminal of the battery before the "+" terminal.
- Never connect the two terminals of a battery together using conductive objects (Tools, etc...)
- When handling the batteries, avoid any spillage of electrolytic liquid by keeping the batteries horizontal. Wear gloves and protective clothing that will prevent any risk of contact with electrolyte in the event of a leak.
- In the event of projection of electrolyte, rinse the affected part of the body abundantly and consult a doctor immediately.

Electric windlass

ATTENTION!

It is essential to run the engine with the throttle slightly open when using the electric windlass.

220 Volts /110 Volts installation (ISO 13297: 2000)

DANGER!

The on-board 220 V installation is protected by a circuit breaker and fitted with a residual current device. The wiring of additional 220 V on-board accessories must be carried out by professionals, and the master circuit-breaker upgraded if necessary.

- Disconnect the boat's power supply when system is not in use.
- Connect the metal cases or housings of installed electrical equipment to the ship's protective conductor (green or green / yellow wire).
- Use double-insulated or earthed electrical appliances.

ATTENTION!

When the boat is moored at the quayside, set the isolator to the 'off' position.

DANGER!

Your boat is not supplied with a shore/boat supply cable or a male plug for the shore outlet. The cable must be suitable for outdoor use. Its cross-sectional area must be adjusted according to its length and the rating of the main circuit-breaker (see electrical diagram). The plug must be suitable for the socket on the shore (if necessary, seek the advice of a professional). This should be as close as possible to the type IP 67/IEC529

- Cut off the quay supply at the circuit breaker installed on board before connecting or disconnecting the boat/quay electric cable.
- Connect the boat/quay electric cable on the boat before connecting it on the quay terminal
- Disconnect the boat/quay electric cable on the quay terminal before disconnecting it on the boat
- Close the protection of the quay connection correctly

Never:

- Change the connections of the ship/quay electric cable; only use compatible connections.
- Swim near a boat connected to the quay: risks of electrocution!

Location of the general 220 V circuit breaker: starboard cockpit cabinet.

Have the system checked every 2 years.

During maintenance out of water, put in "on" position to have a **ground protection** via the quay connection.

WARNING

Never let the end of a ship/shore supply cable dangle into the water. It may create an electrical field that could injure or kill nearby swimmers.

IV. GAS INSTALLATION

Operating advice

- Read carefully all instructions for cooker and regulator before use or maintenance.
- Ensure that the gas cylinder and regulator are in accordance with the requirements of the cooker (flow rate, pressure, type of gas) and with the regulations in force in the country where it is being used.
- Make sure the appliance gas taps are closed before opening the valve on the cylinder.

WARNING

- Equipment burning fuel with a naked flame consume the oxygen in the cabin and reject products of combustion in the boat. Proper ventilation is necessary: open the designated vents while these appliances are being used.
- Never block the ventilation openings and ensure that this type of equipment with smoke outlets functions correctly.
- Never use the stove/oven as a heating appliance.

- Do not obstruct quick access to the elements of the gas installation (cylinder locker, shut-off valve).
- The gas cylinder must always be stowed in the sealed, ventilated space provided. The same applies to spare or empty cylinders. Keep protective devices, hoods and stoppers in place. No other equipment must be stowed in this space.
- Do not leave the boat unattended when gas equipment is operating.
- Close all taps on the circuit when the boat is not occupied (stop valve, expansion valve), even when the gas cylinder is considered empty. In the latter case, detach the valves.
- Never smoke while entering the boat when it has been closed; ensure there is no smell of gas.
- If you smell gas, close the circuit valves and the cooker taps, ventilate the boat, and find the leak before using the installation again.

WARNING

In the event of an emergency, the circuit valves must be closed immediately.

ATTENTION!

Certain precautions must be taken to avoid any contact with naked flames or other hot areas.

Checking the gas circuit (ISO 10239: 2000)

Test the LPG system for leaks before use.

Check that all connections are gas-tight as follows:

- close all valves on appliances
- open the valve on the cylinder
- wait for the pressure to stabilize
- close the valve on the cylinder
- Observe the value of the pressure gauge for 3 minutes; if it decreases, there is a leak, do not to use the connected equipment
- find the leaks by using a leak detector or by application of soapy water (tap of the bottle open, all others closed) and foaming solution conforming to the standard EN14291
- have any leaks repaired before putting the system back in service; all repairs and modifications to the system should be done by a qualified professional.

ATTENTION!

Do not use solutions containing ammonia.

DANGER!

Never use a flame to look for leaks.

Flexible hoses must be:

- Checked regularly, at least once a year,
- Replaced if the expiry date marked on the hose is passed,
- Replaced five years after the date of manufacture that may be marked on them,
- Replaced in the event of damage.

Changing the gas cylinder

DANGER!

- Turn off the taps to the stove and anything before the stove before changing the cylinder.
- Do not smoke, or use a naked flame during the replacement of the gas cylinder.
- Ventilate the compartment where the gas cylinder is kept adequately during replacement.

WARNING

In the case of an LPG installation:

- never leave the boat unattended when equipment burning LG with naked flame are in operation.
- refrain from smoking or using a naked flame while LPG cylinders are being changed.
- to turn off the tap on the empty cylinder before disconnecting it to replace it.

V. DRAIN & SANITATION SYSTEM

Characteristic of the exhaust system (ISO 15083: 2003)

Pump type	Theoretical flow rate
Manual	38 L /45 compressions min
12V Electrical	2000 L /H

Read the operating and maintenance instructions for your boat's bilge pump carefully.

ATTENTION!

The level of the water in the bilge must be kept to a minimum.

WARNING

The bilge pump system is not designed to handle water entering as a result of holing of the hull. It is intended to remove water coming from spray, leaks from seacocks or other moderate leaks.

ATTENTION!

- Ensure that the bilge pumps are working before taking to sea.
- Regularly clean the sump and the points or suction strainers of the pumps of any remains which could block them.

If the watertight bulkheads that isolate the fore- and after-peaks are fitted with valves, they should normally be kept closed and should be opened only in order to drain the water into the main bilge.

- identify each hand pump and its lever.
- Locate the switch for the electric bilge pumps on the electric control panel.

Pressurized fresh-water pump

Fresh water is supplied to the sink and washbasins by an electric pump. A filter is installed upstream of the pump, it must be cleaned regularly.

Never allow the pump to run if the tank is empty. Refill the tank before using the water supply again.

The tanks can be sterilized using Clonazone® tablets (available from pharmacies). Every year, remove the inspection covers and clean them by filling with water containing a bactericidal detergent; leave it to act for a few hours, then rinse two or three times. During wintering, fill the tanks up completely to avoid the development of algae or bacteria, or if there is a risk of freezing, empty the tanks; never use anti-freeze.

Hot water is produced by a water-heater connected to the engine cooling circuit and the shore electric supply.

After the water-heater has been emptied, make sure that the element is covered before power is re-applied.

Seacocks

Seacocks are of the ¼-turn type:

- OPEN position: handle in line with seacock body,
- CLOSED position: lever perpendicular to the valve body.

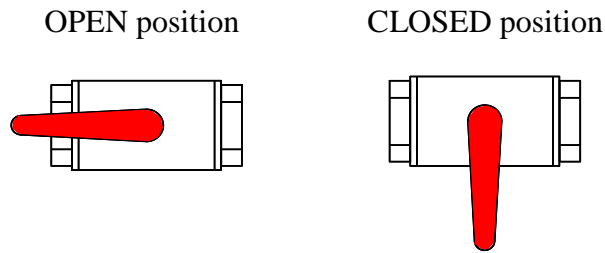

ATTENTION!

- Never touch when tightening of the valves on the hull. In the event of a leak, consult a professional.
- During bad weather or when leaving your boat, close all the valves of sanitary circuits.
- Keep seacocks closed when not being used. Remember to open and close them regularly to maintain their flexibility. If a valve goes unused for too long, it can end up binding.
- For wintering, clean and rinse the skin fittings and the valves. Inspect brass fittings; slight surface corrosion is normal.
- In the event of more serious corrosion, consult your retailer.

Operation of sea toilets

- Open the sea-water inlet seacock.
- Open the bowl emptying seacock.
- Set the lever to the “FLUSH” position.
- Operate the pump.
- To empty the bowl and avoid any water slopping when heeling, set the lever to the “DRY BOWL” position.
- Operate the pump until the bowl is dry.
- Repeat these flushing / emptying operations as many times as is necessary to ensure complete emptying of the pipes.

When toilets are not being used, set the lever to the «DRY BOWL» position, or the «CLEF» position for certain models.

- **Close seacocks after use, as the toilet is below the waterline.**
- Change the toilet seals regularly.

Operation of the holding tank (ISO 8099: 2000)

ATTENTION!

Where a holding tank is fitted, take care to lock the discharge valve, to avoid any accidental discharge during wintering.

- The black water tank (45 L) functions with the WC manual pump.
 - The contents of the toilet pan are discharged straight into the holding tank;
 - Periodically check that the vent is working properly.
 - A deck plate is provided for emptying the tank
 - The discharge valve can be sealed in the closed position.
 - Envisage cleaning the tank with a biodegradable disinfectant once per season.
- Leave the system empty when docking the boat in negative temperatures

VI. FLOODING

To avoid the risk of flooding the boat:

- Before putting to sea, always check that portholes, deck hatches and any other openings that could allow flooding are shut.
- While under way, close all seacocks when they are not in use, except for the engine water intake.
- Do not exceed the maximum recommended loading.

Periodically check:

- Skin fittings, seacocks and pipes are watertight
- Proper emptying of the cockpit drains.
- Stern glands or sail-drive seals for watertightness.

WARNING

Cockpit locker lids must be fastened shut before putting to sea. This is particularly important for those lockers that represent a major flooding risk.

VII. FIRE PROTECTION

Installation

Given that the extinguishers are subject to national regulations; these are not provided with the boat.

However, when in service, this boat must be equipped with portable extinguishers with following extinction capacity and installed in the following locations (see sketch in appendix 15):

- N° 1 - in the section before the mess bench - extinction capacity 1 kg - 5A34B
- N° 2 - entrance of the aft cabin - extinction capacity 1 kg - 5A34B
- N° 3 - cockpit locker, within range of the coxswain – extinction capacity 1 kg - 5A34B

If you choose to install an extinguisher using carbon dioxide, this can only be placed in dwellings with live electric equipment (for example, electric motors, batteries compartment, electrical panels) or flammable liquids (for example, kitchen).

Only compatible replacement parts must be used in fire protection systems. They must bear the same markings and be technically equivalent.

In addition, a fire-resistant cover must be installed near the kitchen, very useful particularly in the event of a stove fire caused by oil (for example: chart table seat).

WARNING

If a CO2 extinguisher is installed, the following information must be posted close to its location:

“ This extinguisher contains CO2 - use it only to fight electrical or kitchen fires. To avoid suffocation after discharging, leave the area immediately. Ventilate before re-entering.”

Do not open the engine compartment immediately after putting out a fire, to avoid the release of toxic smoke or spraying of burning materials (oil, water).

Safety instructions

ATTENTION!

It is the responsibility of the owner / skipper to:

- to ensure fire safety equipment conforms with the manufacturer instructions and the regulations of your country.
- to replace the fire safety equipment if it is out-of-date or is discharged, by extinction equipment of equal or higher capacity.
- to ensure the members of crew know:
 - the location and how to operate the fire fighting equipment
 - the location of the discharge opening in the engine compartment
- to ensure that the fire fighting equipment is easily accessible when the boat is occupied.
- to always keep a clean and tidy hold and to regularly check for the presence of fuel or gas vapour.

Never:

- Block the passages towards the emergency exits (bridge panels).
- Block the safety controls (gas valve(s), fuel valve(s), electric switches)
- Block the storage compartments containing the extinguishers.
- Leave the boat unoccupied with a stove or heating lit.
- Use a gas lamp in the boat.
- Fill the fuel tank or change a gas cylinder when the engine, the stove or heating is operating.
- Smoke while handling fuels or gas.
- Hang free hanging curtains near the stove or any other equipment using an open flame.
- Store combustible products in the engine compartment.

VIII. ENGINE

Regular maintenance must be carried out in accordance with the engine manufacturer's recommendations. Read care-fully the engine operating instructions that come with the boat. Do not hesitate to consult your agent or a qualified professional. In particular, follow the instructions for wintering.

General precautions

ATTENTION!

Do not use sail and engine if the heel angle is more than 10°.

Any engine change must respect the capacities of the boat and be performed by an engineer specializing in marine mechanics.

ATTENTION!

After first launching and tensioning of rigging, check the alignment of the propeller shaft or the sail-drive flange ring.

- Ensure that the ventilation openings (vent, engine ventilation grille) are not blocked.
- Ensure that coolant circuit water valve is opened, and that there is water leaving the engine exhaust.
- Boats equipped with swivel joint tube gland: purge the air of the tube gland after each launch.

Put the throttle in neutral before starting the engine to keep the boat from moving and/or the propeller from turning.

On subsequent launches, a brief check of propeller fixing can be made. Incorrect operation of the folding propeller will lead to vibration

Regularly check the condition of the anodes and ensure that they are suitable for the boat's environment (fresh water, salt water). Change the anodes every year. The 3 anodes have an average life of 1–2 years.

These anodes are made of zinc. It is essential not to use magnesium ones. Impressed current cathodic protection systems should not be used

If the anodes are not eroded, you need to check:

- that they have not been painted over,
- that they are correctly fixed and in contact with the hull,
- and that they are indeed made of zinc

Exhaust gas emission

DANGER!

Internal combustion engines produce carbon monoxide. Prolonged exposure to exhaust gasses can have serious consequences, and may even cause death.

Safety

DANGER!

In order to avoid all risk of serious injury from the propeller, the engine must not be started when there are people swimming near the boat.

Whenever possible, the engine must be stopped for any engine maintenance or checking operations. Otherwise, special attention must be paid to moving parts (propeller shafts, belts, etc.) in order to avoid any risk of injury.

Wintering

Read carefully the operating and maintenance instructions for the engine that goes with your boat and the instructions for wintering.

In the absence of other instructions, proceed as follows:

- Close the engine water intake seacock,
- Disconnect the pipe from the engine water intake seacock,
- Drain the sea-water circuit,
- Place the pipe into a drum of -25° anti-freeze coolant,
- Run the engine until the fluid comes out of the exhaust,
- At the end of this operation, re-connect the pipe to the seacock,
- Attach a notice to the electrical panel and the battery isolator to the effect that the engine water intake seacock is closed.

IX. FUEL INSTALLATION

In the event of deterioration, flexible fuel pipes must be replaced by pipes bearing the same markings. Do the same for all fuel lines.

ATTENTION!

- Depending on the trim and the loading of your boat, the full rated fuel capacity may not be usable. Always maintain a 20% reserve for safety.
- Avoid contact between flammable materials and the hot parts of the engine.
- Clean any possible fuel spills in the boat during the filling of the tanks.

Never:

- Store inflammable material in non-ventilated spaces.
- Smoke while filling the tanks.
- Block the ventilation openings (vent, engine grille ventilation): ensure that they are never blocked.
- Make changes to the installation except with a technician fully qualified in this field.

X. STEERING SYSTEM

The steering system plays a vital role in the safety and comfort of your boat.

Helm

The **DUFOUR 335** is equipped with a double helm with a system of tiller ropes and chains and emergency tiller.

Regular verifications: check the play in various elements (rudder spindle/blades, tension and wear of mechanical elements) and lubricate the pinion and chain if necessary.

In the event of any doubt or problem, consult your agent.

Emergency tiller

ATTENTION!

- The **Dufour 335** is equipped with an emergency tiller which must remain easily accessible, we recommend that you to store it in a locker in the nacelle cockpit.
- It has been designed to sail at reduced speed in the event of damage to the helm.

To use it:

- Unscrew the deck-plate to reveal the head of the rudder stock
- Fit the tiller onto the head of the rudder stock.

XI. SAILING

WARNING

In all situations, suit the speed of your boat to the surrounding conditions and always maintain a safety margin. Pay particular attention to:

- to the state of the sea, the currents, the wind strength.
- other boats
- manoeuvres in ports
- passing through mooring areas.
- Obey priority rules as defined by the rules of road and imposed by the COLREGS.
- Ensure that you always leave enough room for stopping or manoeuvring if necessary to avoid a collision
- Respect speed limit zones.
- Out of courtesy and for the safety of other boats ,take care not to create a large wake near other boats

WARNING

- You must equip your boat with life lines. Anchor-points are provided on the deck. Please refer to the deck fittings plan for your boat.

• the stability of your boat was studied by taking account of the mass of the boat in light condition, with the standard equipment on board and with the options from the builder's catalogues.

Any alteration to on-board weight distribution (for example: adding a radar, changing the engine, etc.) can affect the stability, trim and performance of your boat.

Breaking waves represent a significant threat to stability.

Towing another boat produces significant extra loading, which will have an adverse effect on the stability of your boat.

- Never:
Lift heavy weights using the boom.

XII. PROTECTION AGAINST LIGHTNING

Your boat is protected from lightning. The rigging is electrically connected to earth. Nonetheless, for your safety, it is necessary to respect certain precautions.

Maintenance

If the vessel has been hit by lightning:

- The protection installation must be inspected to detect physical damage and check the integrity of the device, as well as the continuity of the earth connection.

- The compasses, electrical and electronic devices must be examined in order to ascertain if damage or calibration changes have occurred.

Protection of persons during a storm

WARNING

During a thunderstorm, it is preferable to obey the following instructions:

- Persons must be secured as much as possible inside the boat.
- Passengers should stay out of the water and not let their arms or legs hang into the water.
- While maintaining satisfactory control of the vessel and its course, persons aboard should not touch any parts connected to a lightning protection system, and especially not in such a way as to form a link between such parts.
- Individuals should avoid any contact with the metal parts of the rigging, the spars, the parts of rigging and the life lines.

XIII. ENVIRONMENTAL PROTECTION & SAFETY

We recommend that you find out about local regulations concerning respect for the environment, and to obey international regulations against pollution in the marine environment (MARPOL), together with the codes of good practice.

ATTENTION!

- Most cleaning products, engine oils and fuels are likely to impact the environment, so they should be disposed of in authorised locations (check with the Harbour Master's office).
- Do not run the bilge pump when oil or fuel is present in the engine compartment, as these chemicals must be legally discharged in authorised locations.
- Certain products can also pose a risk to your safety and that of others, which is why it is important to read and follow the instructions for use.
- Chemicals must be labelled and stored in an appropriate place on the boat.

XIV. SAFETY FACILITIES

There is no harmonization of mandatory safety equipment across the European Community. You should find out about current national requirements for CE-marked vessels.

In France, the skipper is responsible for ensuring that recreational craft bearing the CE mark carry aboard the mandatory handling and safety equipment stipulated for the relevant sailing category.



Use of the safety ladder if your boat is equipped

Your boat is provided with a stowage position for a life-raft, read the life-raft instruction manual carefully. The crew must be made familiar with the use of all the safety equipment (harnesses, flares, life-raft, etc.). Sailing schools and clubs regularly organise training sessions.

XV. HANDLING, TRANSPORTING, HAULOUT

When craning, take care that the slings are correctly positioned and are not fouling the propeller, the sail-drive or a fragile transducer.

Lifting frames must be wide enough, or fitted with spreaders, so as to avoid applying excessive lateral pressure on the rubbing strakes.

Avoid allowing slings to foul the life-lines. During transport or haul out, the keel should be in proper contact with its support and should be taking most of the boat's weight.

Cradle pads must be positioned against structural elements and exert only the pressure necessary for the boat to be properly balanced.

Take advantage of the opportunity provided by haul-outs to inspect the propeller, rudder, skin fittings, and transducers.

ATTENTION!

Aft lifting point is located near the sail-drive.

Charte pour la mer et les rivières

*L'eau est un milieu vivant, fragile.
C'est aussi une ressource précieuse.*

Pour protéger ce milieu,

- Je respecte la mer et les rivières, je n'aborde pas les sites protégés, je limite ma pêche aux espèces et tailles autorisées, j'observe les animaux sans les toucher ni les déranger.
- Avant de mouiller, je m'informe de la nature du fond pour éviter sa dégradation. De préférence, j'utilise les bouées d'amarrage.
- Je dépose mes déchets ménagers dans les containers et mes déchets toxiques, solides et liquides à la déchetterie portuaire.
- J'utilise les installations sanitaires portuaires. Je vidange mon bac à eaux noires dans les stations de pompage. J'utilise les produits détergents les plus respectueux de l'environnement.
- Je m'assure que toute opération d'entretien (bateau, matériel, équipement) est effectuée dans le respect de l'environnement. Je manipule avec précaution tous les liquides susceptibles de polluer lors de leur transvasement.

Décembre 1999





Au service des plaisanciers et des professionnels de la mer

Les sauveteurs en mer veillent...

Tous les marins savent qu'on ne badine pas avec la grande bleue ... Malgré les progrès considérables réalisés en matière de sécurité par les constructeurs de bateaux, un événement de mer est toujours possible et vous pouvez avoir un jour besoin des « sauveteurs en mer ».

A toute heure du jour et de la nuit, 7 jours sur 7, 3 500 bénévoles sont prêts à appareiller dans la demi-heure pour aller porter secours à ceux qui sont en difficulté ... et cela parfois au péril de leur propre vie !

C'est grâce au maillage très serré de ses 255 stations en France et dans les D.O.M. que « Les Sauveteurs en Mer » assurent aujourd'hui près de 50% du sauvetage en France.

En mer, vous pouvez avoir besoin d'eux, à terre ils ont besoin de vous...

Le sauvetage des vies humaines est gratuit mais les moyens mis en oeuvre coûtent cher. Les sauveteurs en mer, qui se recrutent de plus en plus parmi les plaisanciers, ont besoin de vous pour entretenir, moderniser et remplacer leurs moyens nautiques (1 canot tous temps coûte 4,2 MF !).

Venez donc soutenir ou même rejoindre ces marins, hommes et femmes, désintéressés, discrets et efficaces : prenez contact avec le responsable de la station la plus proche du port d'attache de votre bateau ou avec notre siège à Paris.



ENTRE MARINS...



- avant de prendre la mer, informez vos proches de vos intentions
- renseignez vous sur les conditions locales (météo, courant, etc)
- possédez des moyens radio VHF fiables et contrôlez-les
- faites porter un gilet de sauvetage aux enfants

**UNE VIE HUMAINE N'A PAS DE PRIX ...,
UN CANOT DE SAUVETAGE EN A UN !**

LES SAUVETEURS EN MER (S.N.S.M.)

Siège social: 31, cité d'Antin 75009 PARIS

Tel: 01 56 02 64 64 - Fax: 01 56 02 64 63 - E-mail: www.snsnm.com.fr



Je soutiens la SNSM et j'adhère !

Je joins un chèque de: 20 € min. 45 € (donateur) - 380 € (bienfaiteur)

Un reçu de déductibilité fiscale me sera adressé avec la carte et l'autocollant de membre

NOM:.....PRENOM:.....
ADRESSE:.....
Téléphone:.....email:.....

XVI. GUARANTEE, TRANSFER OF OWNERSHIP

A) CONTRACTUAL GUARANTEES

Note: This guarantee does not apply to boats being used for commercial purposes (any hiring or chartering activity specifically falls into this category) nor does it apply to sailing boats taking part in competitions, which may be covered by special guarantees.

8 - Guarantees

a) New boats and equipment:

8.1.1 – For both Commercial Purchasers and private consumers domiciled outside the territory of the European Union, the Seller is required to furnish the statutory guarantees defined (in the context of the sale of vessels) by Articles 1641 and 1648 of the French Civil Code and (in the context of a marine construction contract) by Articles 7 and 8 of Act no. 67.5 dated 3rd January 1967 pertaining to vessels.

8.1.2 - For Purchasers domiciled within the territory of the European Union and taking out the contract as private consumers, the Seller is required to furnish the guarantees as defined in the context of a boat sales contract by Articles 7 and 8 of the Act dated 7/1/1967 pertaining to vessels, and in the context of the Order (2005-136) dated 17/2/2005 and incorporated into the French Consumer Code. Independently of this guarantee, the Seller remains liable for discrepancies between the goods and the contract and for redhibitory defects under the conditions provided for under Articles 1641 to 1649 of the French Civil Code (see 8.1.1).

8.2 – Visible defects: acceptance by the Purchaser releases the Seller from their obligation in respect of discrepancies and visible defects.

8.3 - Contractual guarantee:

Except for guarantee or penalty clauses expressly agreed at the time of accepting the order, the Seller's guarantee is granted under the following conditions:

- The Purchaser benefits from a contractual guarantee running for two years from the date of acceptance of the vessel, as noted on the acceptance report.
- This is limited to the replacement or free repair, at the yacht-builder's discretion, of any parts acknowledged as being defective by the yacht-builder's technical services; this being without any other compensation of any kind.
- For components and accessories visibly bearing the mark of another supplier, the guarantee is limited to the guarantee offered by that supplier.
- It is stipulated that any handling, transport, parking, or conveying costs incurred in carrying out these operations remain the sole liability of the buyer/user, unless DUFOUR YACHTS yacht-builders offer to waive

them in full or in part.

- The yacht-builder's contractual guarantee excludes:
 - the cost of transporting the boat or any parts, and any consequences thereof, together with expenses and/or any damage arising out of the inability to use the boat and/or the equipment;
 - normal wear and tear;
 - cracking, crazing, or discolouration of the gel coat;
 - damaging resulting from:
 - fortuitous events or cases of force majeure;
 - conversions and modifications, or repairs, even partial, carried out other than in work-shops authorized by the maker;
 - failure to observe the maintenance recommendations set out in the Owner's Manual supplied with the boat;
 - improper use, in particular through negligence, carelessness, abuse, or abnormal usage;
 - participating in competitions;
 - failure to take necessary protective measures;
 - unsuitable storage or transport conditions.

In order to benefit from the yacht-builder's contractual guarantee, each time they make a claim under it, the buyer/user will be required to submit the boat delivery certificate and the guarantee document, duly completed, and, on pain of rendering it void, must notify their dealer/vendor of the fault or defect in writing, in detail and with justifications, within 15 days of its being discovered.

8.4 – the guarantee covers usage at sea in wind and sea conditions acceptable for safety and in accordance with the vessel's approval category. Under these conditions, it cannot under any circumstances cover events arising during or resulting from collisions, groundings, breaking seas, tidal waves, cyclones, severe storms, and all other exceptional events and/or events arising out of an error of seamanship.

8.5 – Loss of or damage to products occurring after handover do not release the Purchaser from their obligation to pay the price.

b) Second-hand boats and equipment:

The order form specifies if the boat or equipment is second-hand. The Purchaser benefits from a contractual guarantee, covering hull and engine only, running for one year from the date of acceptance of the vessel or goods, as noted on the acceptance report.

c) In addition to the contractual guarantee detailed above, the Seller remains liable for discrepancies in the goods and for latent defects under the conditions provided for under Articles 1641 to 1649 of the French Civil Code and the provisions of the Order dated 17/2/2005, where applicable.

B) COMMON GUARANTEE CONDITIONS

Any claim under these guarantee conditions must be made formally to **DUFOUR YACHTS** in writing as soon as the defect is discovered, and within eight (8) days for claims under the contractual guarantee. Any claim will also be required to quote the serial number of the boat concerned, and where applicable the part number(s) of the part(s) involved in the guarantee claim.

Furthermore, the request must indicate the exact circumstances under which the problem occurred.

DUFOUR YACHTS, in order to investigate the claim, may ask for any details and appoint, at its own expense, a surveyor or technician of its choice to determine the circumstances of the occurrence of the problem and demand any necessary papers.

Immobilization following problems encountered and/or replacement and/or repair work, whatever the duration, does not create entitlement to compensation.

The owner shall under all circumstances remain liable for parking fees, customs dues and other ancillary expenses.

All repairs and/or all replacements will be carried out by approved **DUFOUR YACHTS** representative or by any professional chosen by the boat builders. If the nature of the repairs requires the guarantee repair work to be carried out in **DUFOUR YACHTS** workshops or in any location other than the place where the Product is located, the owner will be liable for the cost of both outward and return transport to the Yacht builder.

In the event of the boat's needing to be taken out of the water, haul-out and re-launching costs will be at the owner's expense.

C) TRANSFER OF GUARANTEES

The guarantees are afforded to the first purchaser of the boat involved. They are only transferable with prior written agreement from **DUFOUR YACHTS**.

An ownership transfer note is supplied with the Product documents. This must be sent to **DUFOUR YACHTS** within thirty (30) days of the transfer.

This note must bear the names, addresses and telephone numbers of the old owner and the Purchaser, the date of sale, and the Product's hull number.

Upon reception **DUFOUR YACHTS** will confirm the guarantee expiry dates and specify whether the unit has received the annual inspection that gives entitlement to the continuation of the contractual guarantees.

D) STATUTORY DECLARATIONS

Article L.211-4 of the Consumer Code:

The seller is required to supply goods that conform to the contract and to assume liability for discrepancies existing at the moment of delivery. They shall likewise be liable for discrepancies arising out of the packaging, assembly instructions, or installation when they are liable for this under the contract or when it has been carried out under their responsibility.

Article L. 211-5 of the Consumer Code:

"In order to conform to the contract, the goods must:

1) *Be suitable for the normally-expected use for similar types of goods and, where applicable:*

- correspond to the description given by the seller and possess the qualities the latter has presented to the buyer in the form of a sample or model;

- present the qualities that a buyer may reasonably expect with regard to public declarations made by the seller, by the producer, or by his representative, particularly in advertising material or labelling;

2) *Either present the characteristics defined by joint agreement by the parties, or be suitable for any special usage sought by the buyer that the seller has been made aware of and has agreed to."*

Article L.211-12 of the Consumer Code:

"Actions arising out of a discrepancy lapse after two years from the date the goods are handed over."

Article 1641 of the Civil Code:

"The seller is obliged to guarantee against latent defects in the article sold which render it unfit for its intended use, or which adversely affect this use to such an extent that the buyer would not have purchased it, or would have only paid a lower price, if he had known about them."

Article 1648, Para. 1 of the Civil Code:

"Actions arising out of redhibitory defects must be brought by the purchaser within two years of discovery of the defect."



TRANSFER OF OWNERSHIP CERTIFICATE
TRANSFER OF OWNERSHIP

Modèle du bateau / Boat model:

N° de coque / Hull N°:

De / From M. / Mr:.....Adresse / Address:

.....

C-P / POST CODE: Ville / City: Tel.:.....

Date d'achat / Date of Purchase:

A ETE VENDU A / SOLD TO:

M / Mr: Adresse / Address:

.....

.....

C-P / POST CODE: Ville / City: Tel.:.....

Date d'achat / Date of Purchase:

Signed at dated

Le vendeur / Seller

L'acheteur / Buyer

DUFOUR YACHTS, on the:

Exemplaire à retourner dans les 15 jours suivant la transaction à :
Return the copy within 15 days after the transaction to:

S A V DUFOUR YACHTS
1 rue Blaise Pascal
17187 PERIGNY CEDEX FRANCE



NOTES

DRAWINGS

1.	<i>Presentation plan</i>	34
2.	<i>Accommodation layout</i>	35
3.	<i>Deck fittings plan</i>	37
4.	<i>Sail plan</i>	39
5.	<i>Halyard and sheet operating diagram</i>	41
6.	<i>220 V circuit diagram</i>	43
7.	<i>220 V electrical installation diagram</i>	45
8.	<i>Fuse location diagram</i>	47
9.	<i>Charging and power system diagram</i>	49
10.	<i>12 V distribution panel diagram</i>	51
11.	<i>12 V Terminal block diagram</i>	53
12.	<i>12 V electrical installation diagram</i>	55
13.	<i>Steering system diagram</i>	57
14.	<i>Gas system diagram</i>	59
15.	<i>Abandon ship plan</i>	61
16.	<i>Fresh-water system diagram</i>	63
17.	<i>Drain system diagram</i>	65
18.	<i>Skin fitting location diagram</i>	67
19.	<i>Mechanical installation diagram</i>	69
20.	<i>Holding tank installation diagram</i>	71
21.	<i>Lifting diagram</i>	73

1. Presentation plan

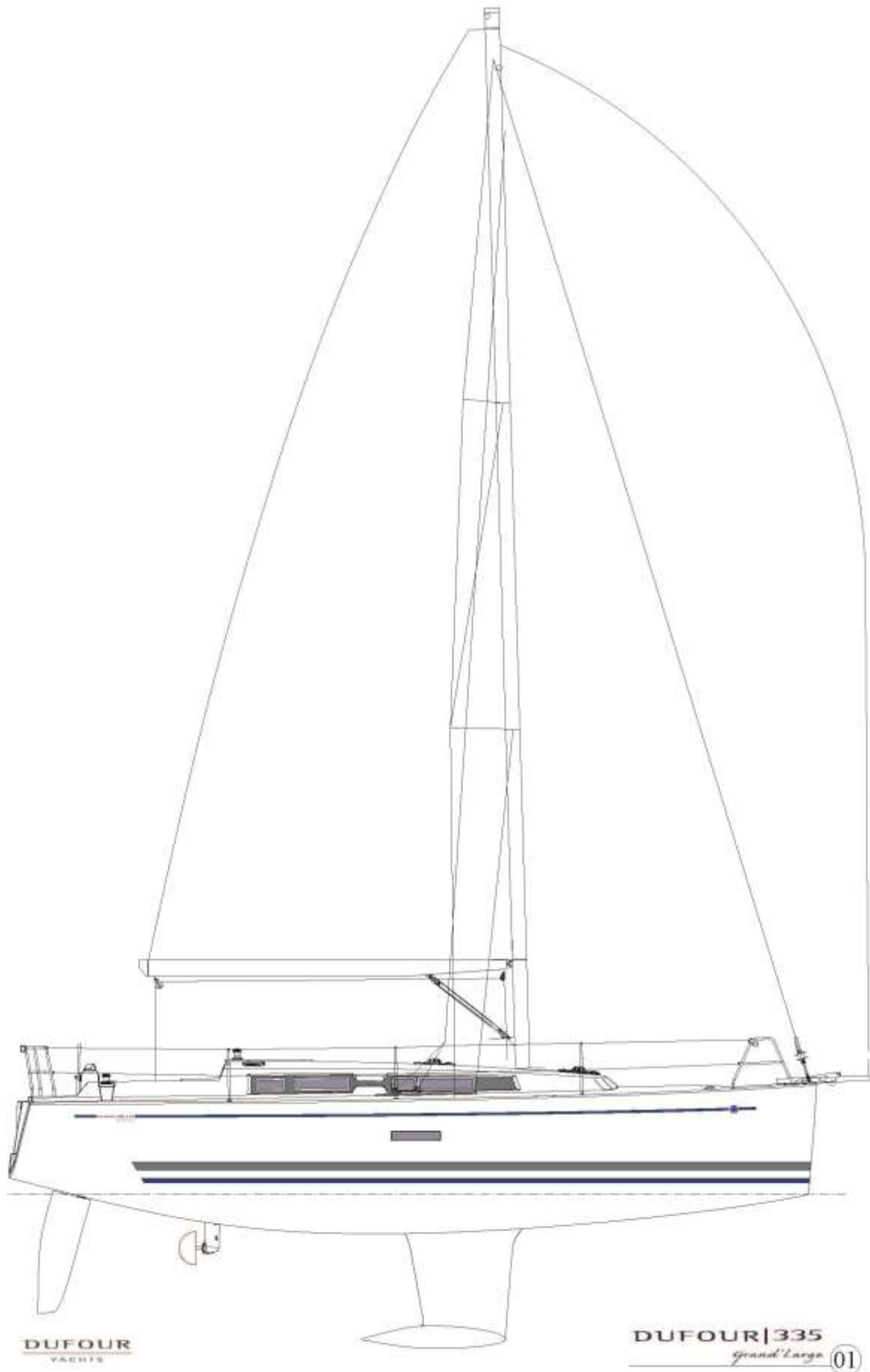

2. Accommodation layout

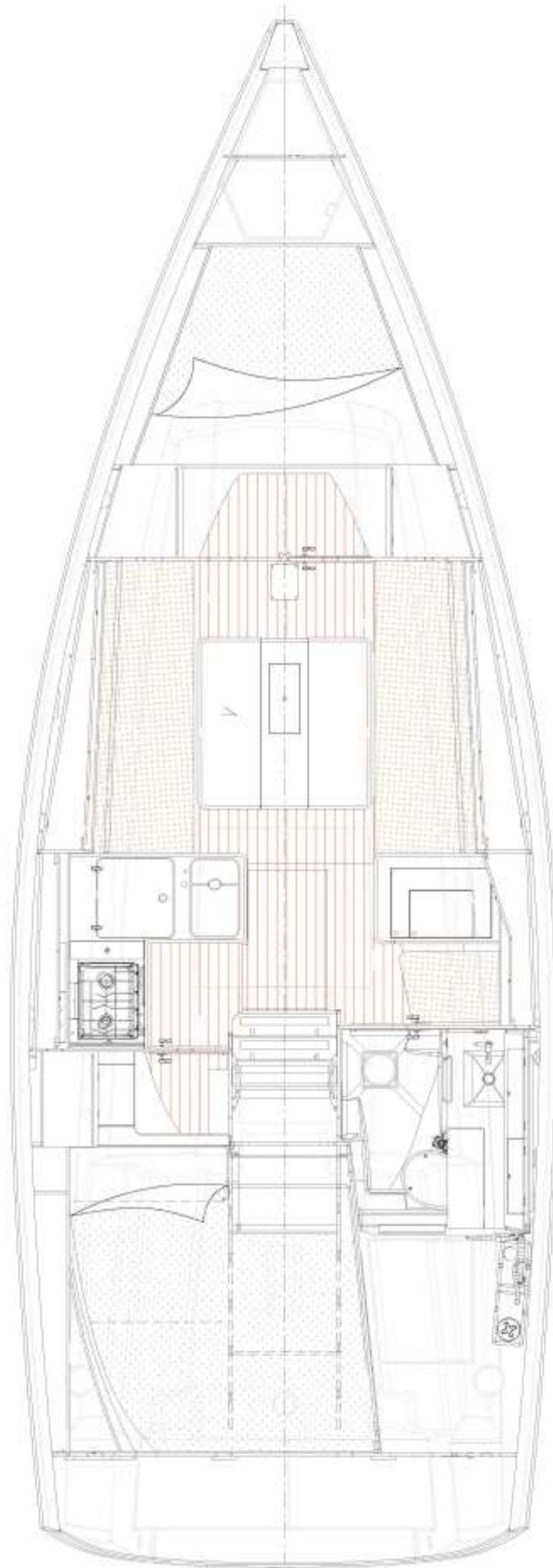

DUFOUR | 335
Grand Large 02

DUFOUR
YACHTS

3. Deck fittings plan

<i>Label</i>	<i>Description</i>
1	Roller anchor fitting
2	Deriggable forestay chain plate
3	Self-steering jib rail*
4	Windlass *
5	Bow rail
6	Lifebelt bracket
7	Telescopic bathing ladder
8	Coach roof handrail
9	Genoa sheet winch
10	Sheet winch
11	Stanchion
12	Stanchion base
13	Fiddle track
14	Diesel deck plate
15	Water deck plate (front* and back)
16	fair leads*
17	Sheave organiser: five port side (std) and four to starboard side*
18	Chain plate for lower shrouds
19	Genoa track with traveller
20	Jib boom storage on mushroom anchor*
21	Rear balcony
22	Swan neck
23	Mooring cleat
24	Main sail chain plate
25	Articulated spinnaker chain plate
26	Winch
27	Halyard winch
28	Case with cranks
29	Genoa sheet pulley
30	Winch
31	Windlass
32	Chain guard
A	Life-line anchor point on starboard and port side mooring cleats
B	Towing points (Sb & pt)
C	Hatches must be closed when underway
D	"Man overboard": reboarding ladder
E	Space provided for stowing life-raft
F	Anchor point for safety harness
G	Compartments (must be closed when underway)
H	Location for the storage of the tender
*	Option

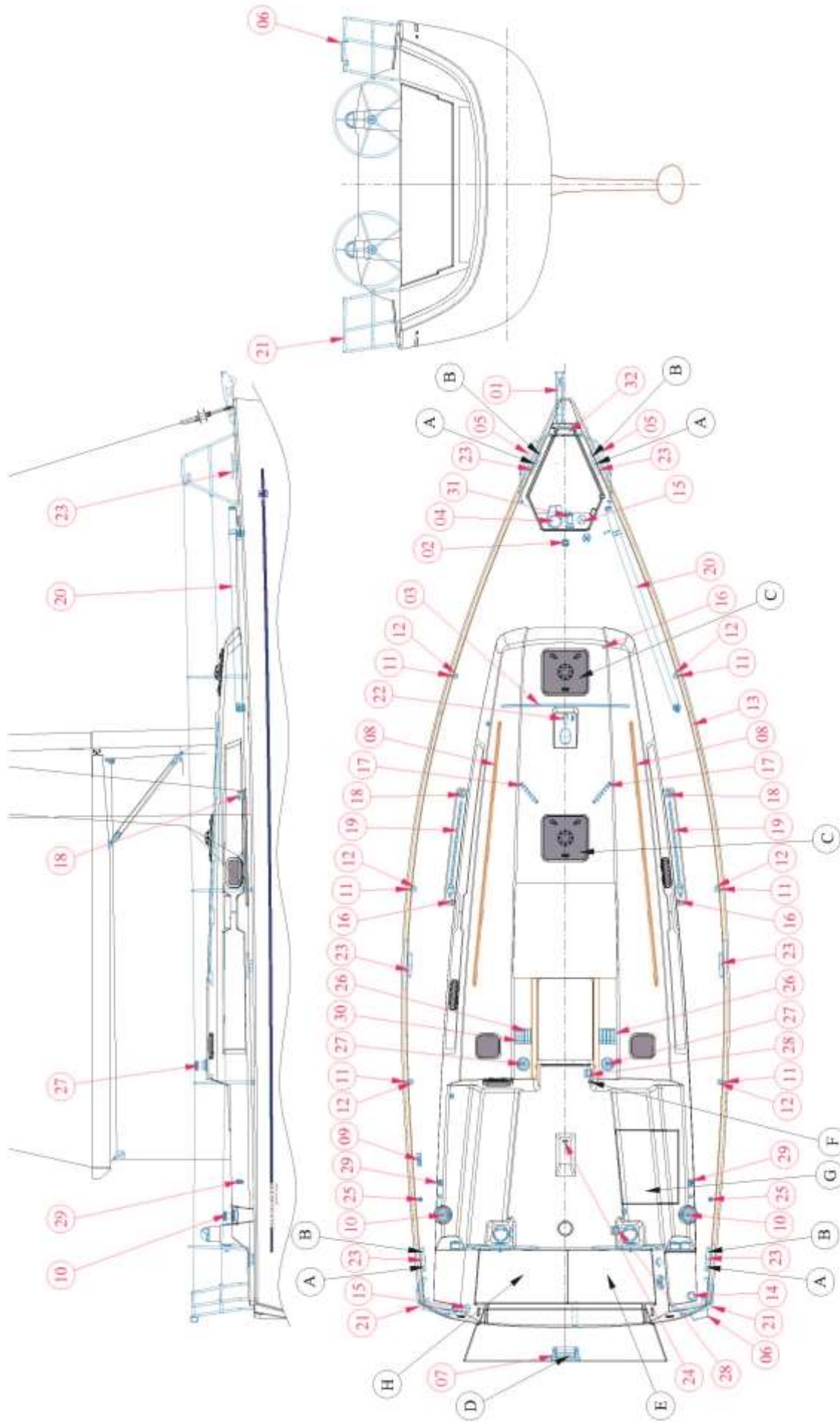

4. Sail plan

I	12.50 m
J	3.47 m
P	11.50 m
E	4.50 m
LP (overlap 128%)	4.48 m
Mainsail area	30 m ²
Genoa area (128%)	25 m ²
Asymmetric Spinnaker area*	83 m ²
* Option	

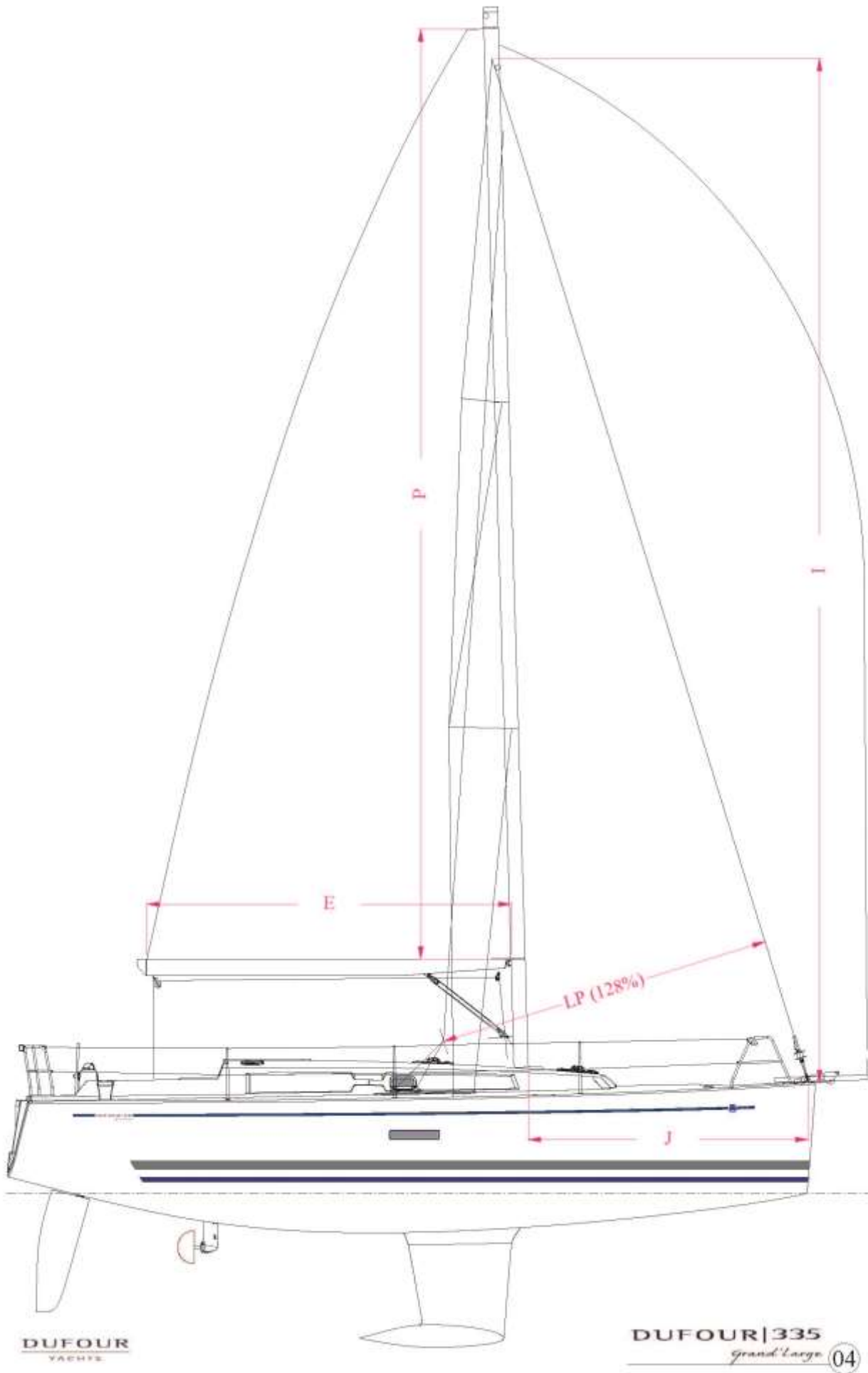

DUFOUR
YACHTS

DUFOUR | 335
Grand Large 04

5. Halyard and sheet operating diagram

<i>Label</i>	<i>Description standard mast</i>
1	Spinnaker tack
2	Spinnaker halyard
3	Releasable forestay halyard
4	Automatic turning jib sheet
5	Mainsheet
6	Boom vang
7	Main halyard
8	Reef line 2
9	Reef line 1
10	Genoa halyard
11	Genoa sheet
12	Asymmetric spinnaker sheet*
*	Option

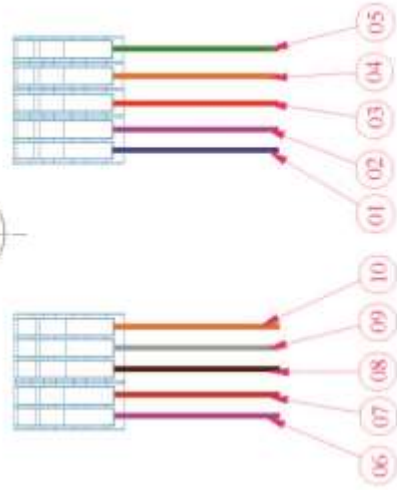
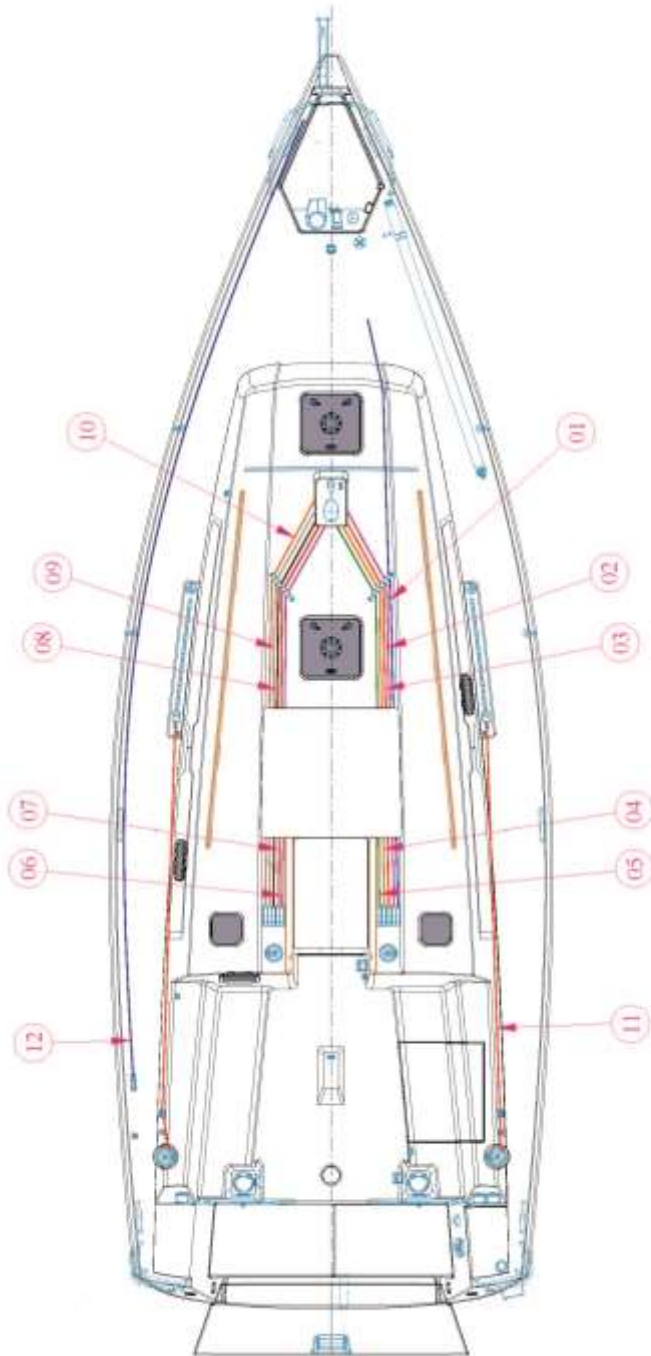
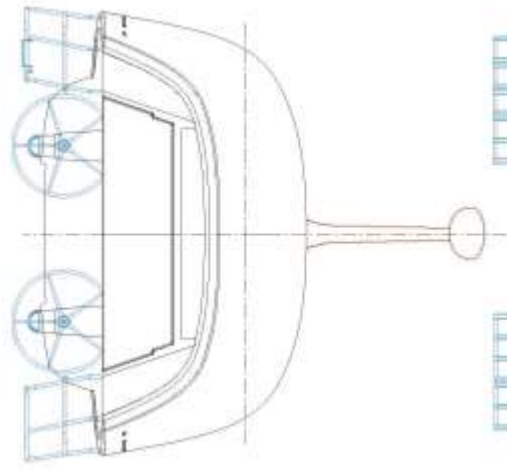
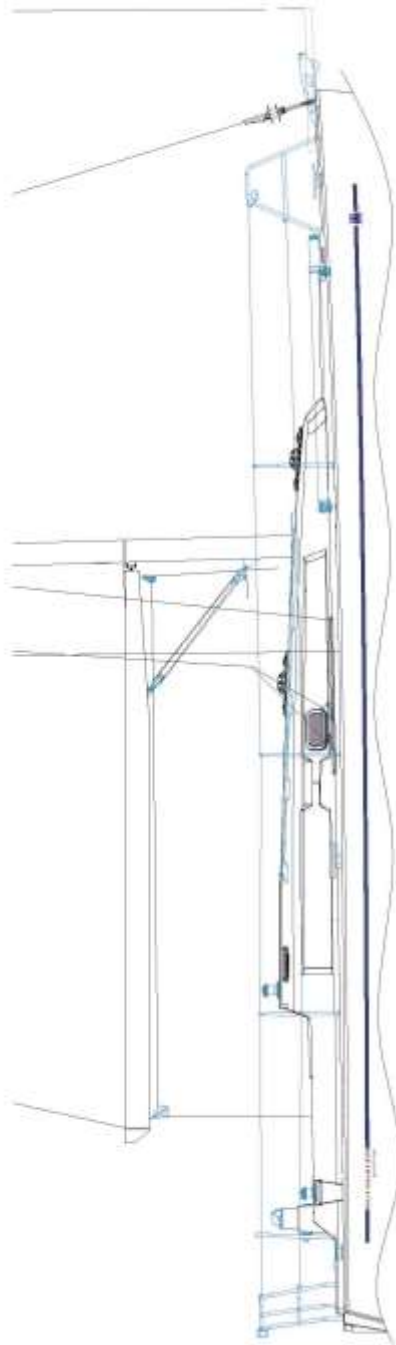

6. 220 V circuit diagram

<i>Label</i>	<i>Description</i>
<i>Equipment</i>	
A	Shore AC connection*
C	Electrical cabinet with master circuit breaker 16A*
D	220V Sockets*
E	EC connection junction box*
G	G Connector*
H	220V Shore cable **
K	Battery charger *
L	Water-heater
<i>Electrical wiring colours</i>	
<i>b</i>	light blue
<i>g</i>	green
<i>m</i>	brown
<i>n</i>	black
<i>r</i>	red
<i>v</i>	green/yellow
<i>w</i>	white
*	Option
**	Not supplied

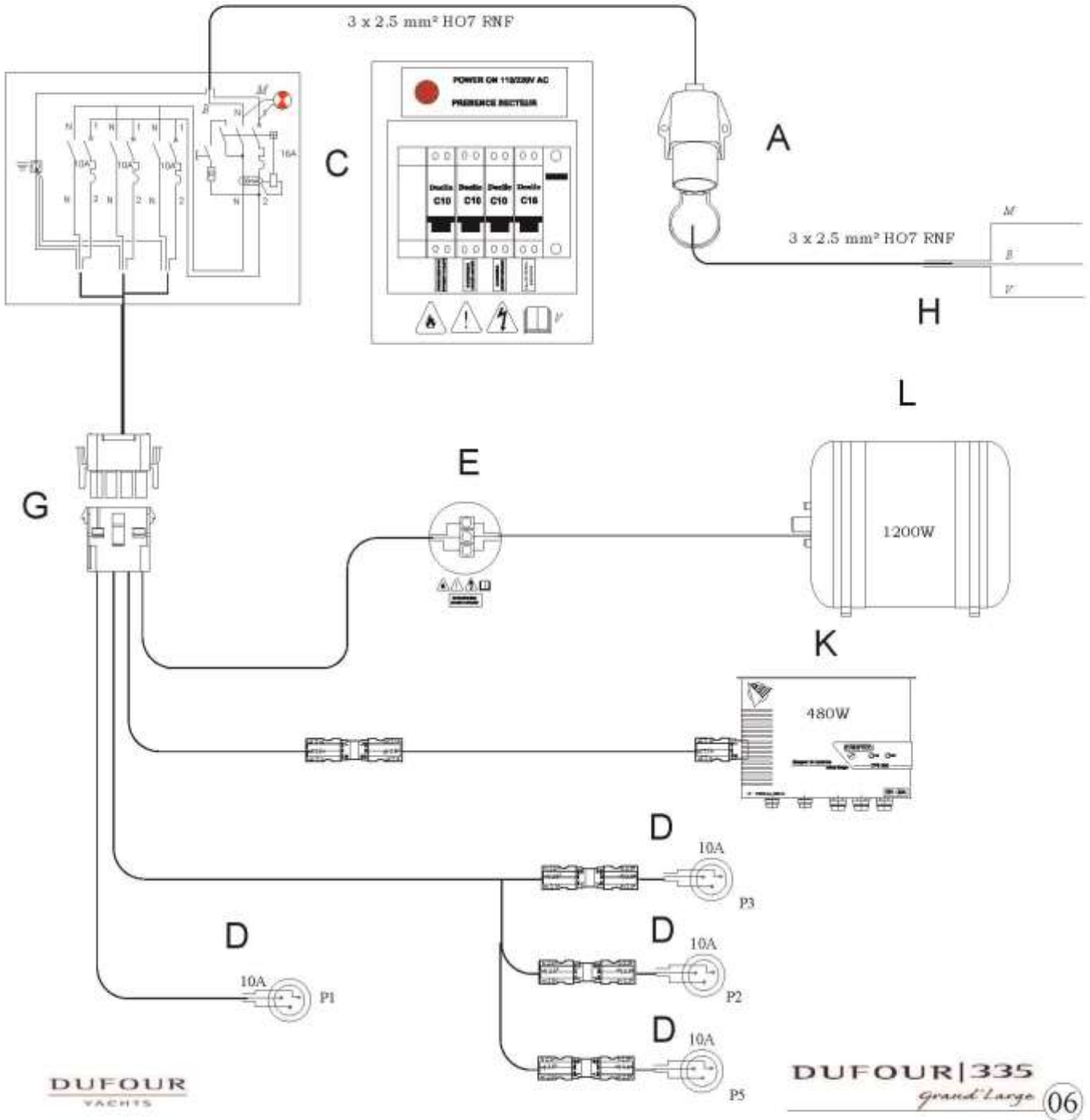

7. 220 V electrical installation diagram

<i>Label</i>	<i>Description</i>
1	220 V (or 110 V) outlet *
2	Water-heater
3	Battery charger *
4	Main circuit-breaker box*
5	G Connector*
6	Shore AC connection*
*	Option

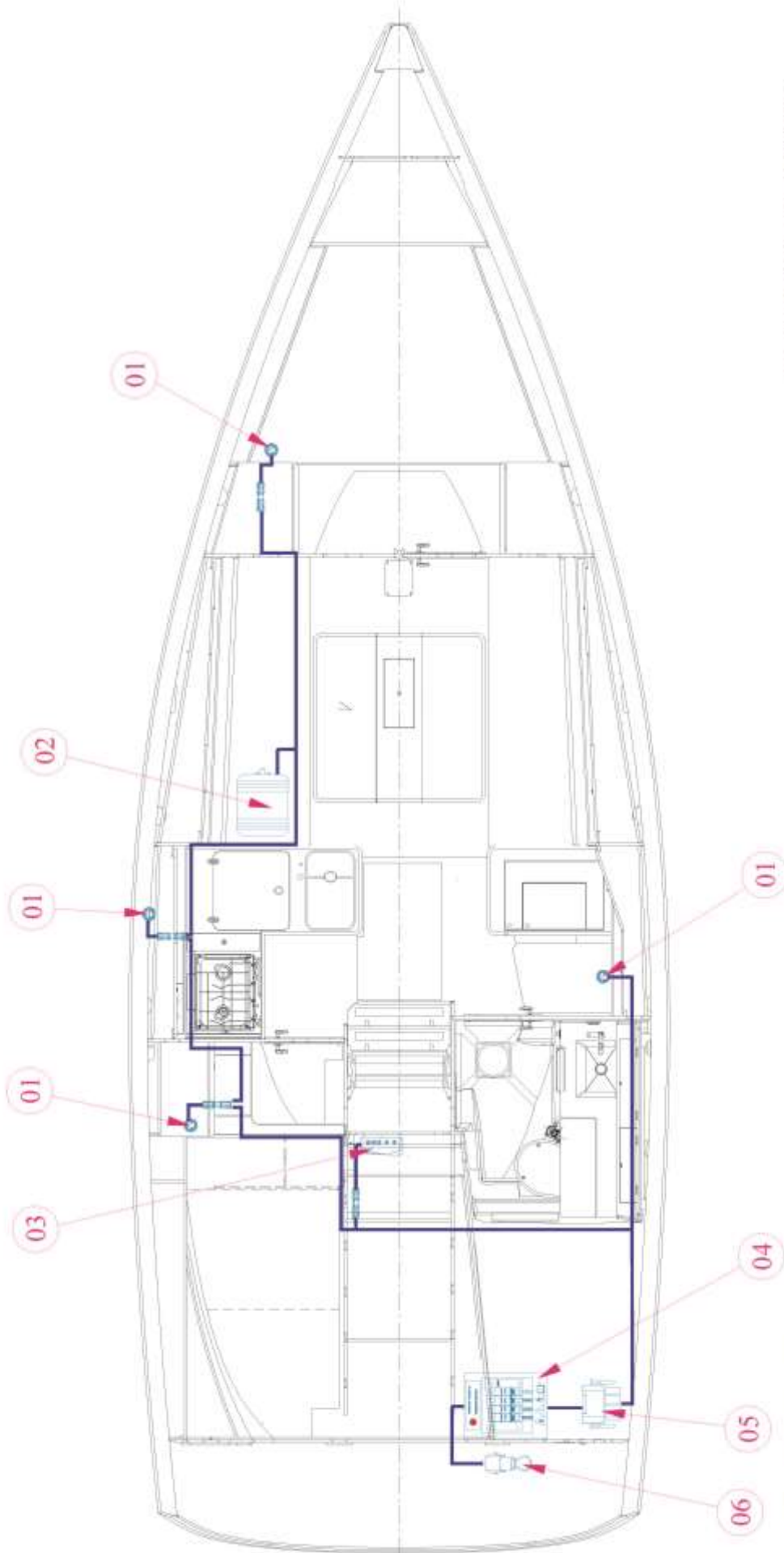

8. Fuse location diagram

<i>Label</i>	<i>Description</i>
A	<p>Zone A - 12 V</p> <p>Blade fuse 30A: option 12/220V inverter*</p> <p>Blade fuse 1A: gas solenoid valve option*</p> <p>Blade fuse 10A: thruster option*</p> <p>Blade fuse 15A: auto bilge pump option*</p> <p>Blade fuse 40A: auto pilot option*</p> <p>Blade fuse 10A: heating option*</p> <p>Blade fuse 5A: windlass option*</p> <p>Blade fuse 5A: navigation instruments option*</p> <p>Resettable circuit breaker type C 80A: windlass</p> <p>Resettable circuit breaker type C 16A: electric WC option*</p>
B	<p>Zone B - 12 V</p>
1	Blade fuse 10A: bilge fan
2	Strip fuse 125A: panel protection
C	<p>Zone C - 6 Module unit 220V</p> <p>Differential circuit breaker 16A: general quayside protection</p> <p>Single phase+neutral circuit breaker 10A: water-heater protection</p> <p>Single phase+neutral circuit breaker 10A: charger protection</p> <p>Single phase+neutral circuit breaker 10A: socket-outlet protection</p>
D	<p>Zone D - 220 V</p> <p>Strip fuse 200A: bow thruster option*</p>
*	Option

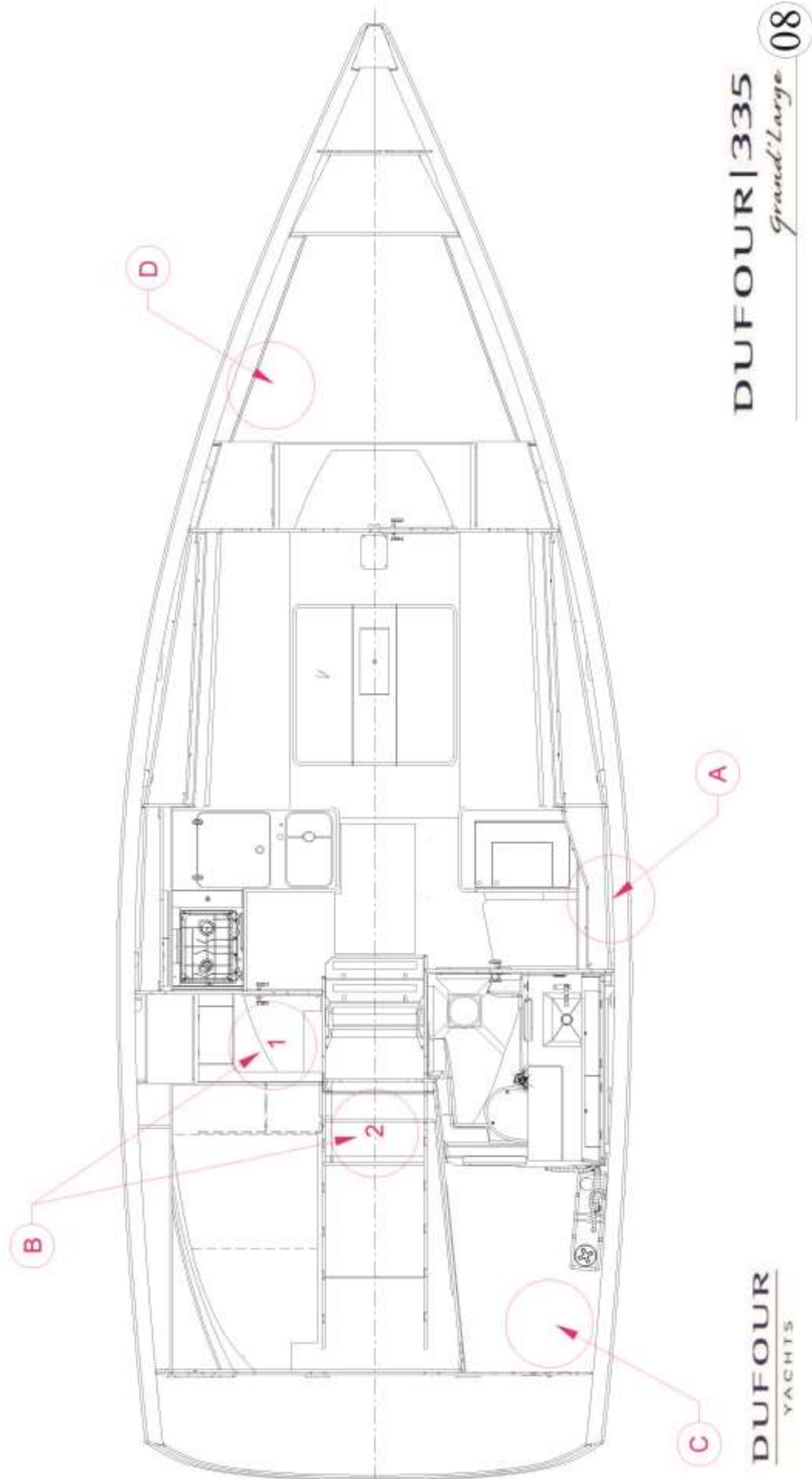

DUFOUR | 335

Grand Large 08

DUFOUR
YACHTS

9. Charging and power system diagram

<i>Label</i>	<i>Description</i>
A	Windlass *
B	Windlass remote control *
C	Remote control relay *
E	Battery charger *
F	12 V distribution panel Single pole circuit breaker 80 A
G	windlass*
H	Auxiliary batteries (1 std + 1 opt.*)
I	Fuse 125 A (auxiliary)
J	House batteries switch
K	5 A fuse*
L	Alternator
M	Splitter
N	Starter
O	Engine battery
P	Engine battery isolator
Q	Windlass relay*
R	Bilge fan relay
S	5 A fuse
T	Bilge fan
U	8 A fuse
B-	-ve terminal (electrical panel)
B+	+ve terminal (electrical panel)
W	Battery test
*	Option

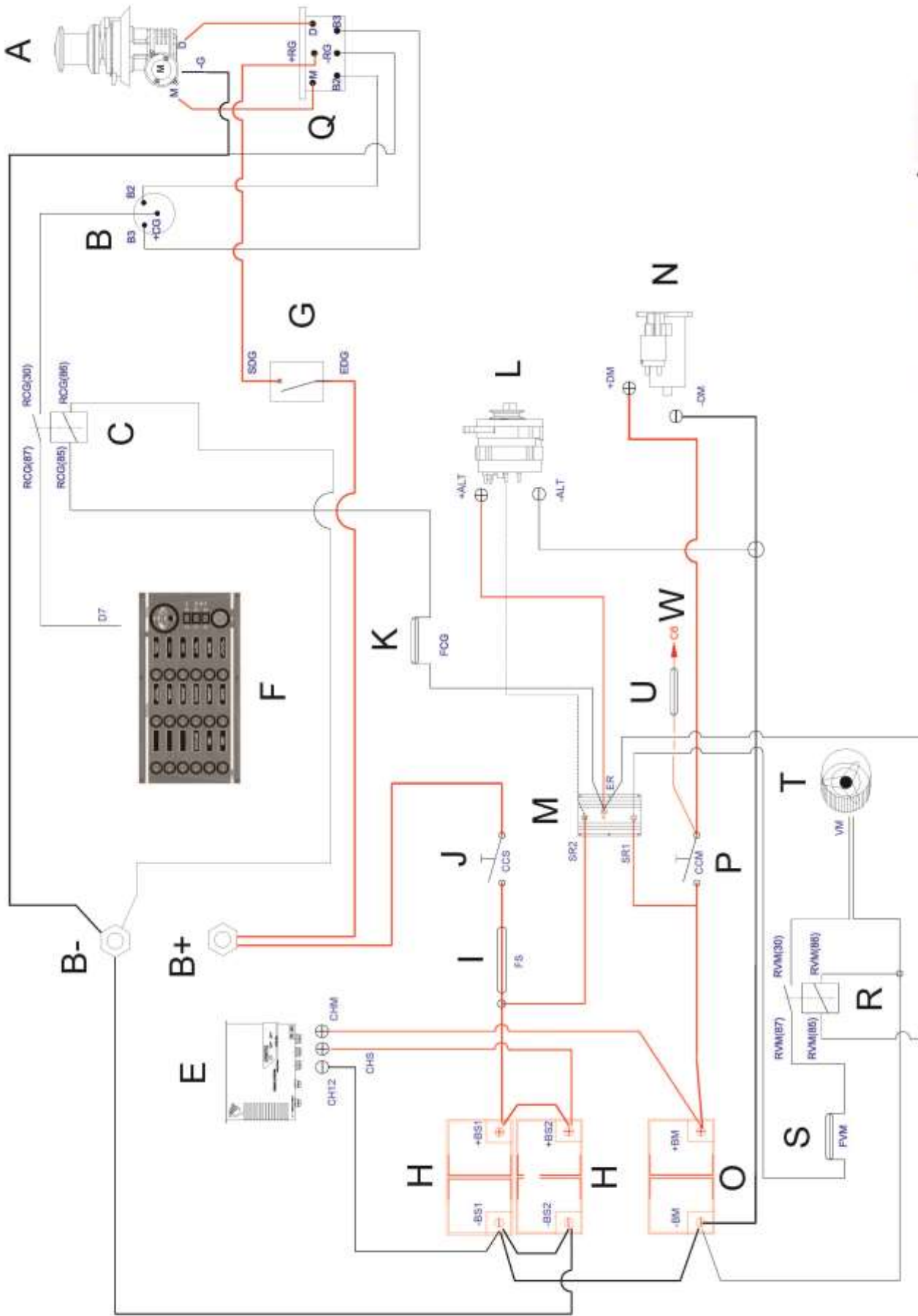

10. 12 V distribution panel diagram

<i>Label</i>	<i>Description</i>	<i>Protection</i>
	<i>12 V distribution panel</i>	
1	Deck light / Spares 1	10 A
2	Miscellaneous 2	10 A
3	Windlass	10 A
4	Water pump unit	10 A
5	Bilge pump	15 A
6	Shower drain pumps	10 A
7	Navigation lights	10 A
8	Mooring light	10 A
9	Steaming light	10 A
10	Refrigerator	10 A
11	Navigation instrument pack	10 A
12	Auto pilot	20 A
13	Saloon lights	15 A
14	Cabins lighting	15 A
15	HIFI / 12 V outlet	10 A

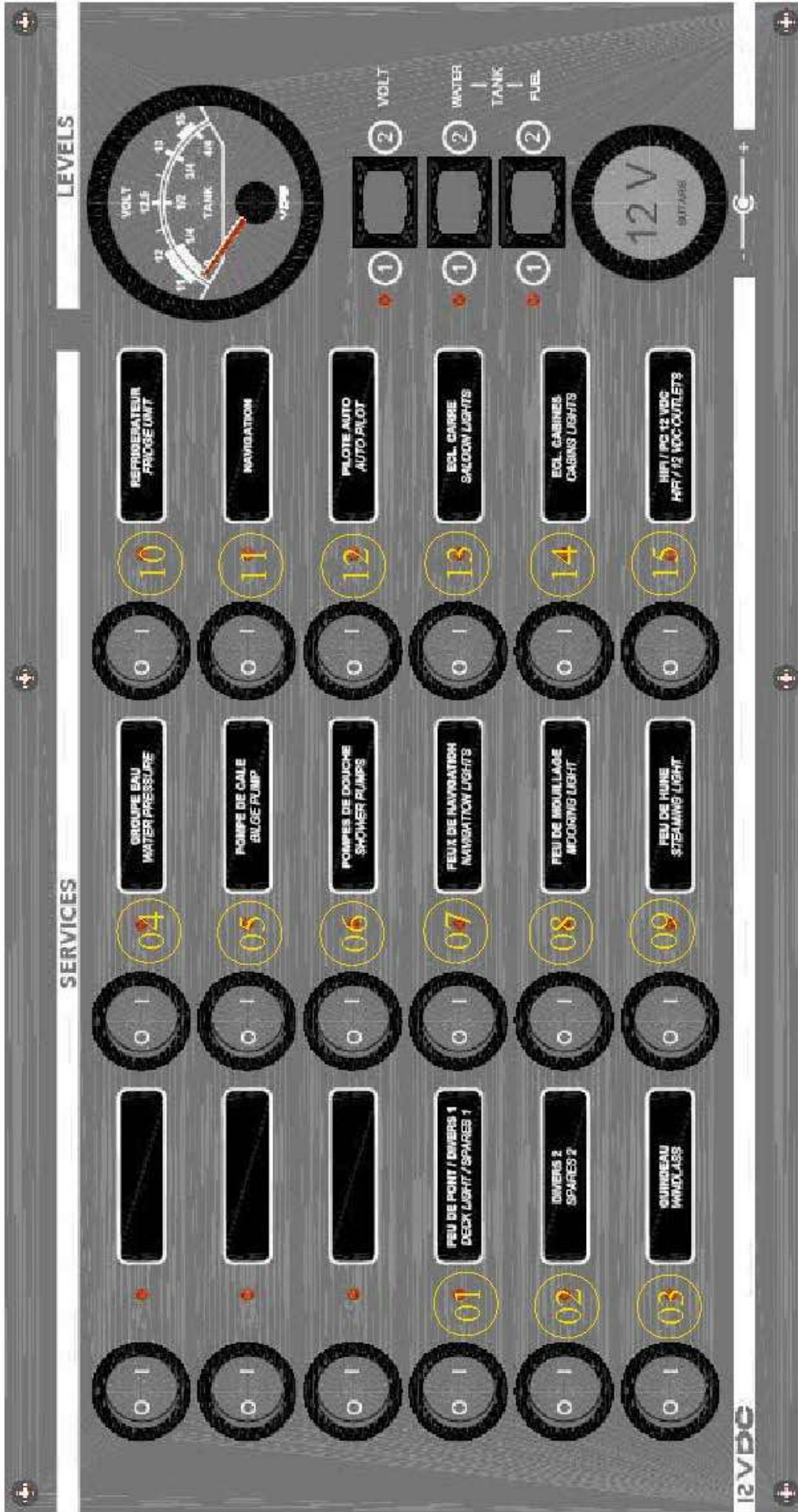

DUFOUR
YACHTS

DUFOUR | 335
Grand'Large

10

11. Terminal block diagram

<i>Label</i>	<i>Description</i>
A	A Connector
1	Water pump unit
2/5	Battery positive
3	Refrigerator
4	Bilge pump
6	Navigation equipment**
7	Shower pump
8	Battery negative
9	Autopilot computer
B	B connector
1	Navigation lights
2/5	Battery positive
3	Saloon and chart table lights
4	Mooring light
6	Cabin and toilet lighting
7	Steaming light
8	Battery negative
9	HI-FI* / 12 V socket
C	C Connector
6	Engine battery test - CCM
1/2/3/4	Aft water tank sensor – D2
9/10/11/12	Fore water tank sensor – D1
5	Diesel gauge transducer - G1
7/8	Negative
D	D Connector
1	Deck lights ** / spare 1
2/5	Battery positive
3	Spares 5
4	Spares 2
6	Spares 4
7	Windlass control
8	Battery negative
9	Spares 3
	<i>Electrical wiring colours</i>
<i>n</i>	black
<i>r</i>	red
<i>w</i>	white
<i>o</i>	orange
<i>m</i>	brown
<i>b</i>	blue
*	Option
**	Not supplied

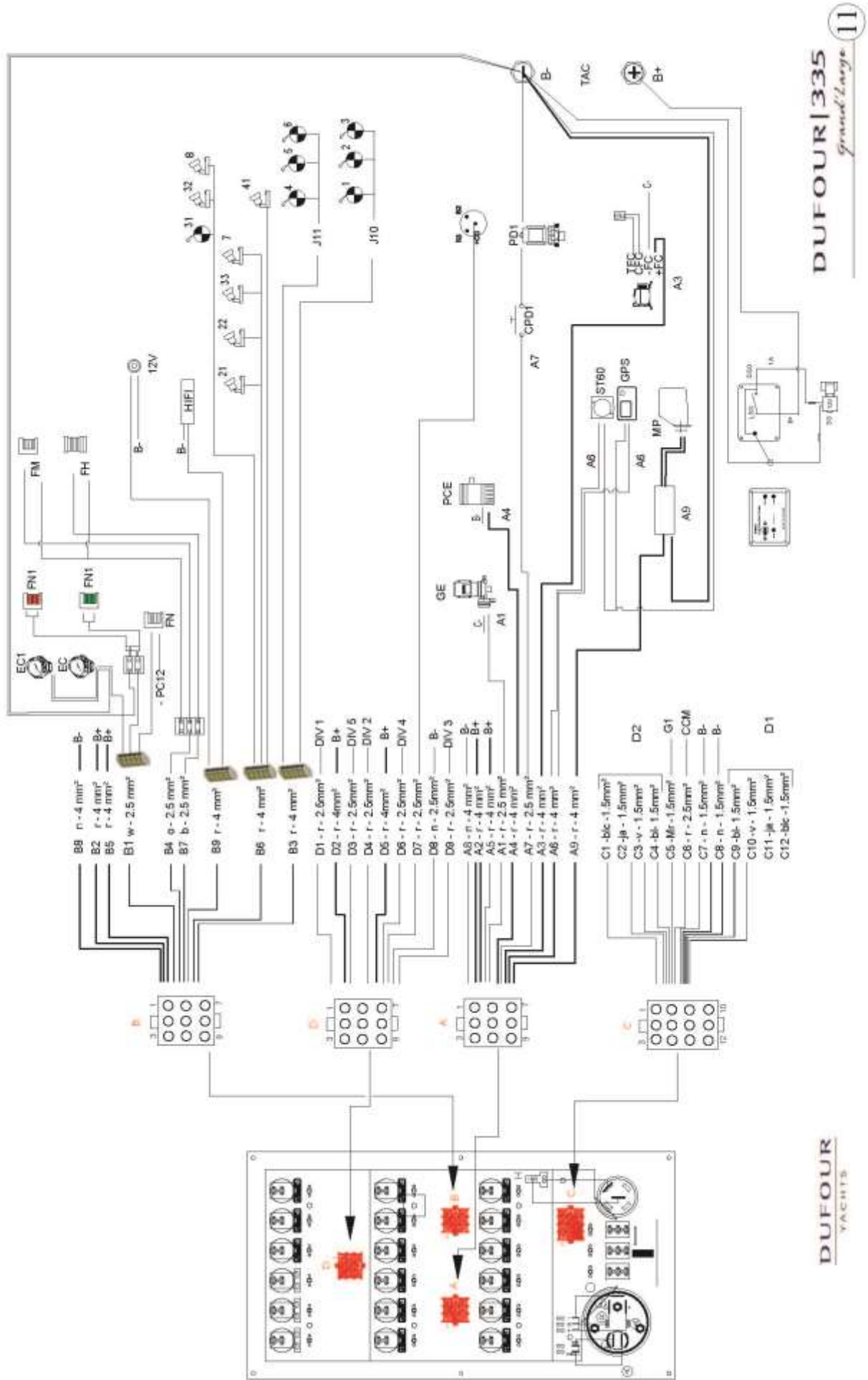

12. 12 V electrical installation diagram

<i>Label</i>	<i>Description</i>
1	Windlass *
2	Windlass relay*
3	Windlass remote control*
4	25A battery charger*
5	Ceiling light with switch
6	Fore fresh water gauge*
7	Aft fresh water gauge
8	Cockpit speaker
9	12V control panel
10	Steering compass
11	Auxiliary fuse
12	Navigation lights on mast head
13	Steaming light
14	Mooring light
15	Deck light
16	Solenoid valve *
17	Gas alarm detector panel *
18	Autopilot motor*
19	Shower pump control
20	Refrigeration unit
21	Shower waste pump
22	Electric bilge pump
23	Engine battery 75 Ah
24	Auxiliary batteries 75 Ah (1 + 1*)
25	Water pump unit
26	Motor fan
27	Chart table reading light
28	Engine and auxiliary battery isolator
29	Waterproof 12 V socket-outlet
30	Alternator
31	Starter
32	Speed sensor / depth sounder*
33	Reading light
34	Saloon loudspeaker
35	Ceiling light without switch
*	Option

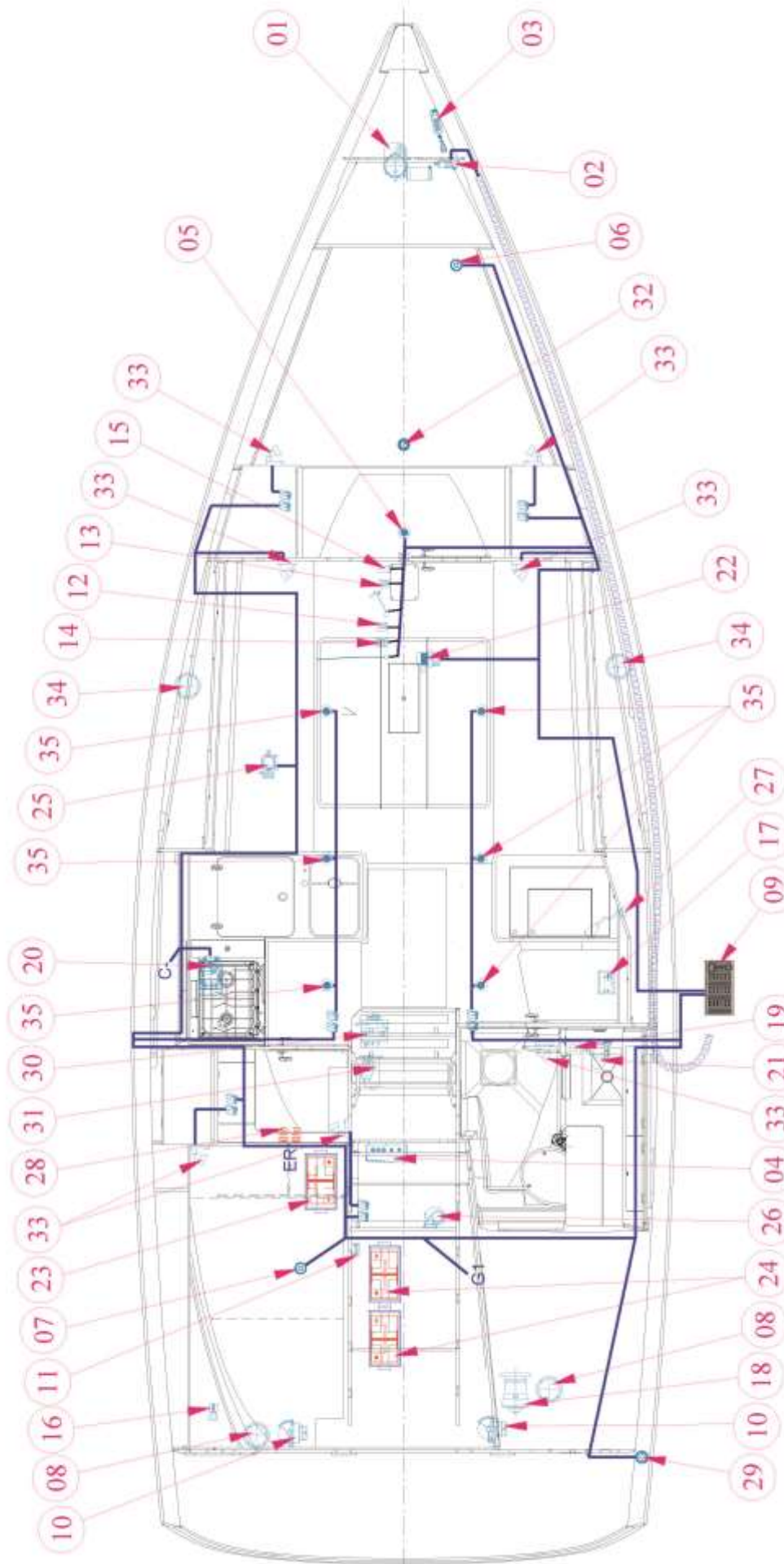

DUFOUR|335
Grand Large

DUFOUR
YACHTS

13. Steering system diagram

<i>Label</i>	<i>Description</i>
1	Rudder blade
2	Rudder stock
3	Steering column
4	Tiller deck plate
5	Rudder trunk
6	Steering wheel
7	Autopilot*
8	Bulkhead fitting
9	Chain + cable assembly
10	Emergency tiller
11	Fixed sheave
12	Quadrant
13	Thrust bearing
14	Lower bearing
15	Swivel bearing
16	Throttle gate
*	Option

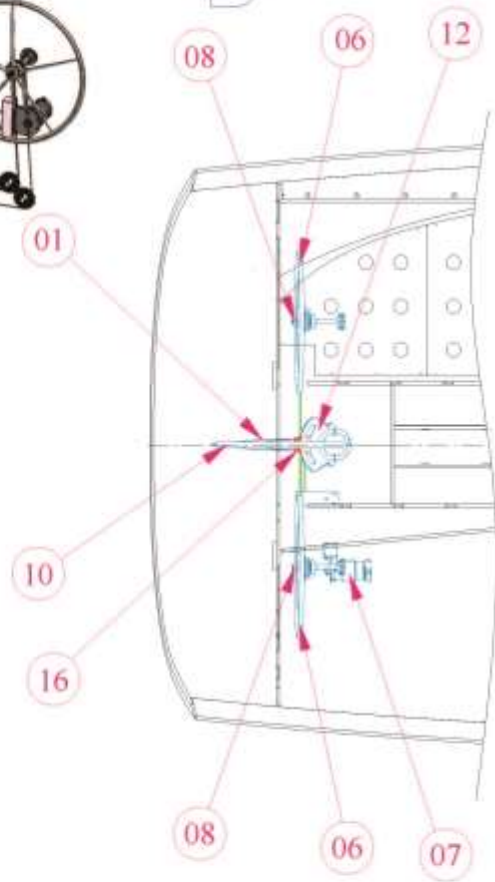
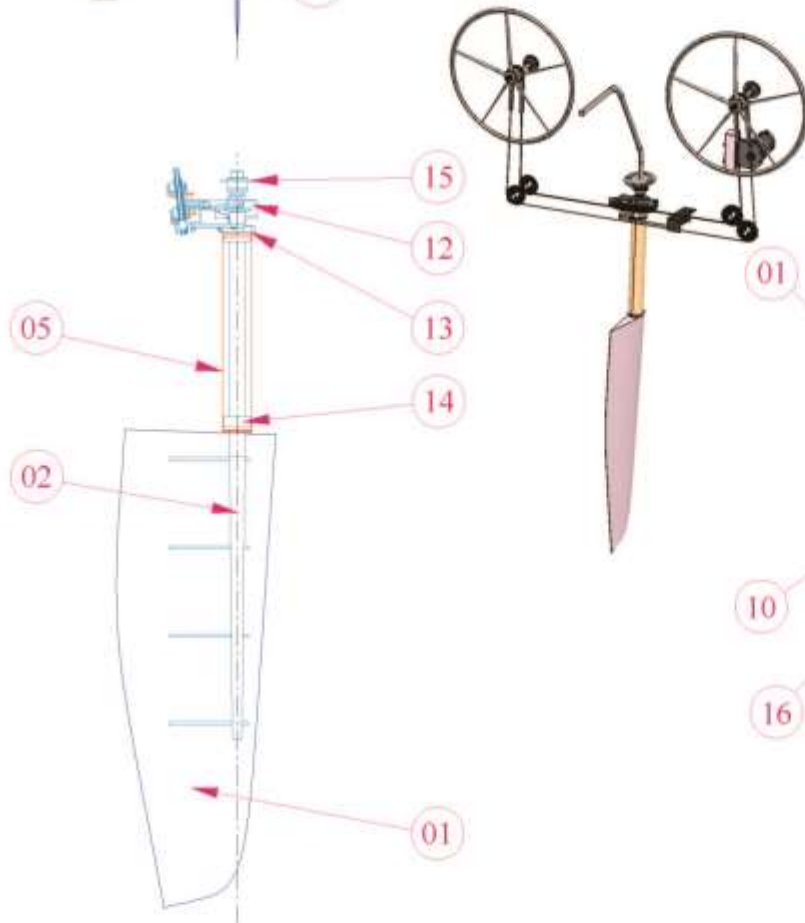
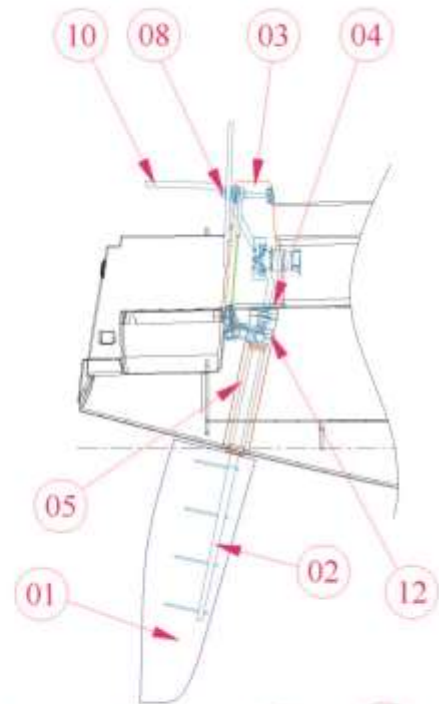
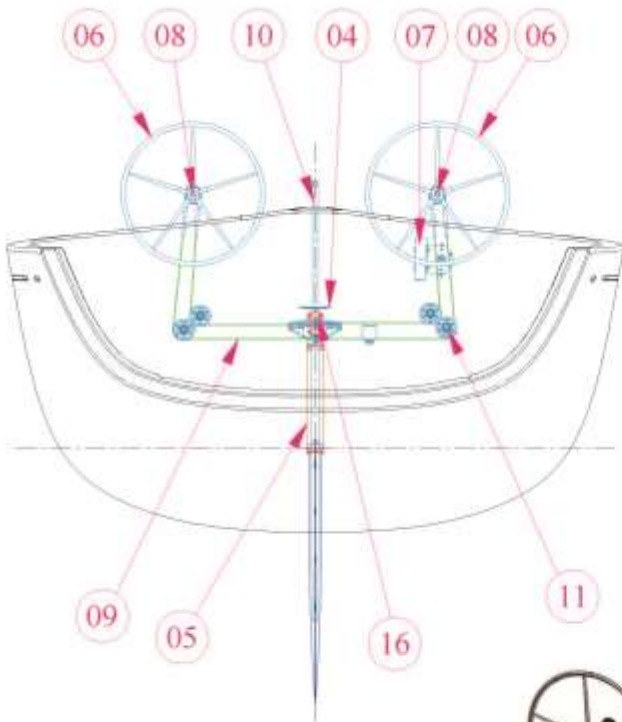

DUFOUR
YACHTS

DUFOUR | 335
Grand Large

13

14. Gas system diagram

<i>Label</i>	<i>Description</i>
1	Gas cylinder 1.8 kg **
2	CE shut-off valve (Fr. or Ger.) **
3	30 mbar CE regulator (Fr. or Ger.) ** / Pressure gauge **
4	Medium-length connecting hose
5	Spacer / tube 6 x 8
6	Watertight bulkhead fitting
7	PVC pipe
8	6x8 copper pipe
9	CE gas shut-off valve (in compartment below oven)
10	Long connection hose
11	Burner and oven
**	Not supplied

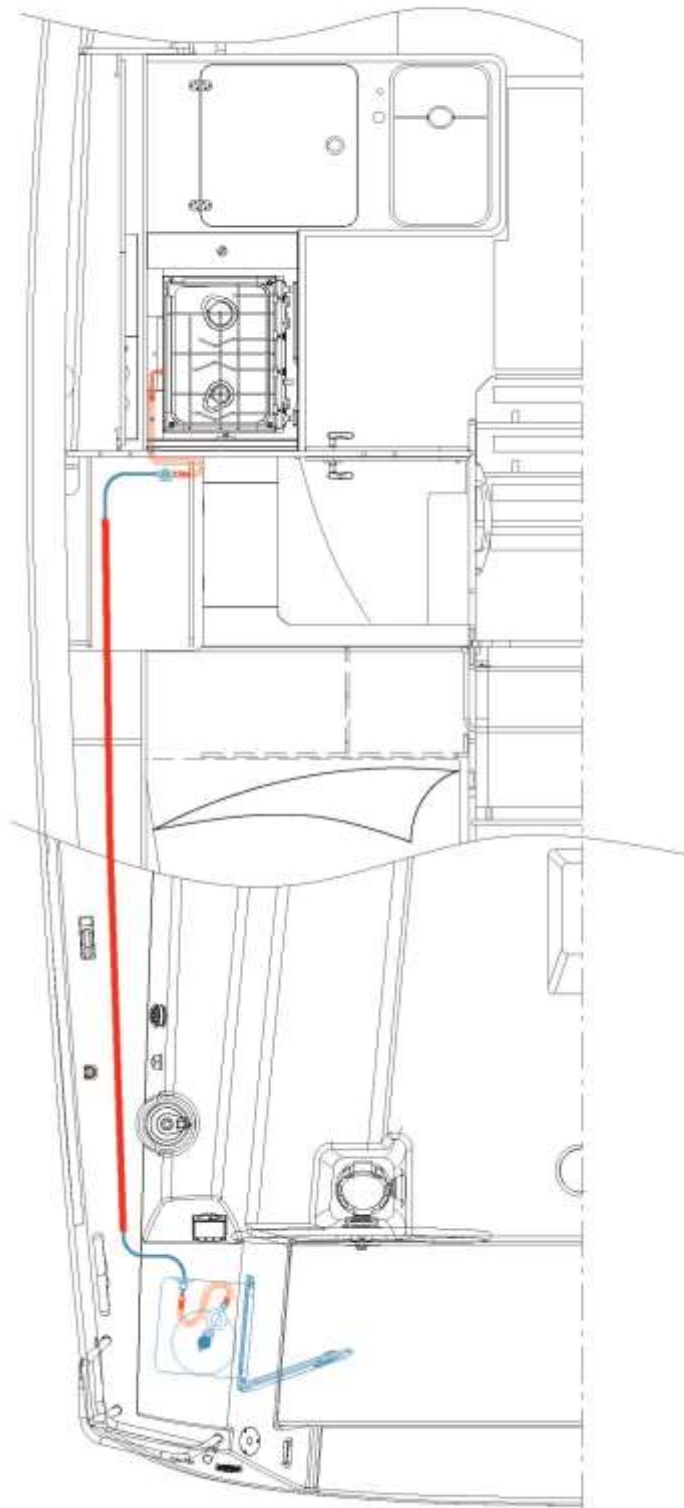
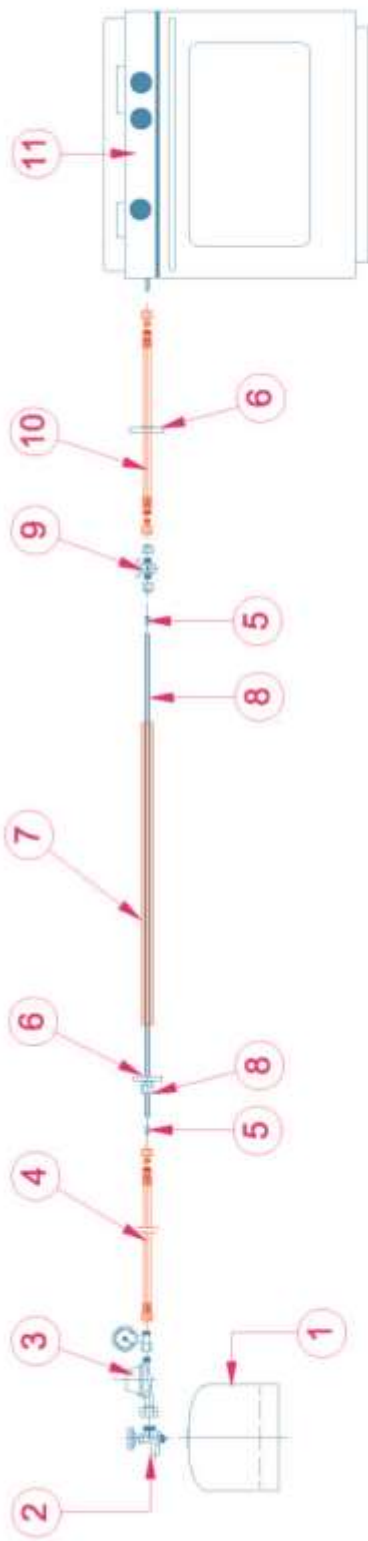

DUFOUR
YACHTS

DUFOUR | 335
Grand'Large

15. Abandon ship plan

<i>Label</i>	<i>Description</i>
Ex	Recommended fire-extinguishers locations
1	Under mess seat: extinguisher, 1 kg, powder 5A/34B **
2	Aft cabin entrance: extinguisher, 1 kg, powder 5A/34B **
3	Cockpit locker: extinguisher, 1 kg, powder 5A/34B **
WH	Engine compartment extinguishing hole
EXIT	Emergency exit
4	Location recommended for the fire-blanket **
**	Not supplied

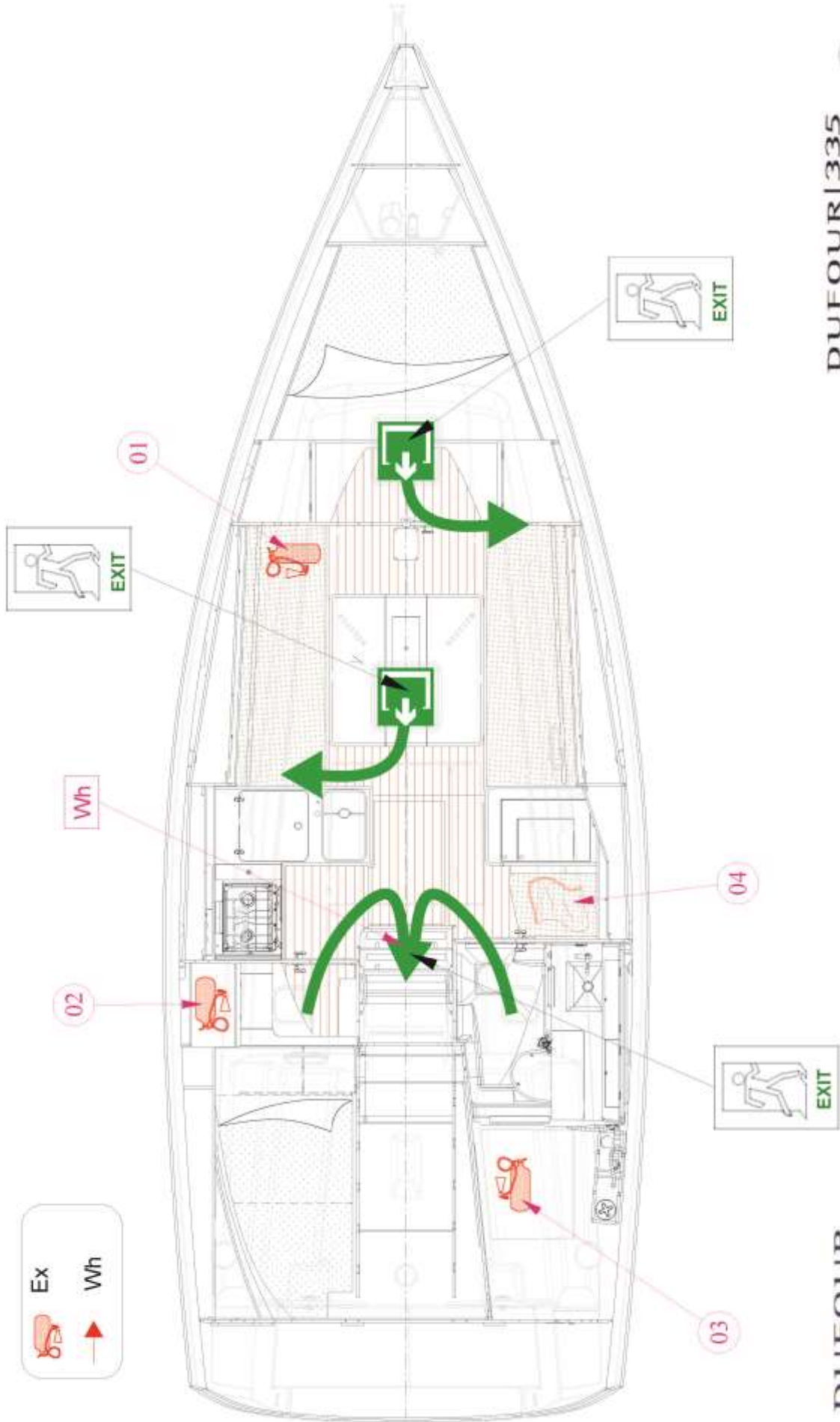

16. Fresh-water system diagram

<i>Label</i>	<i>Description</i>
1	Filler deck plate (fore* and aft)
2	Filler hose (fore* and aft)
3	Vent (fore* and aft)
4	Vent hose (fore* and aft)
5	Stern water tank 200 L
6	Hot water pipe
7	Cold water pipe
8	Water pump unit
9	Fresh-water pump
10	Water-heater
11	Head shower single-lever mixer tap
12	Galley single-lever mixer tap
13	Deck shower
14	Fore water tank 160 L*
15	1/2" 2-way manifold* (1/2 valve as std)
16	3/4" Plug*
17	1/4 turn FF 1/2" valve*
18	3/4" WX F connector*
19	1/2" WX M connector*
*	Option

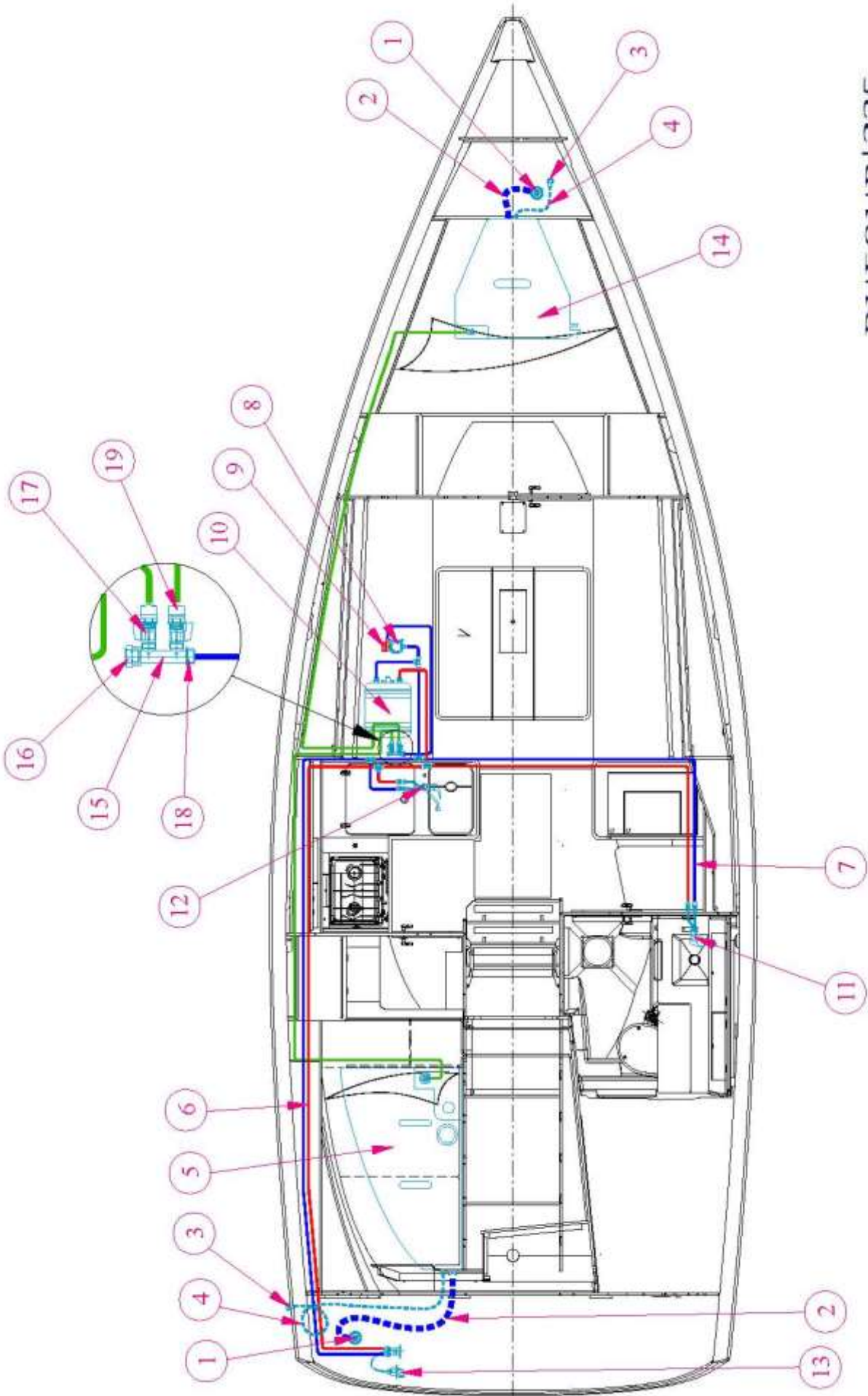

DUFOUR | 335

Grand Large

16

DUFOUR
YACHTS

17. Drain system diagram

<i>Label</i>	<i>Description</i>
	<i>Electric bilge pump</i>
1	Ø20 discharge hose
2	Electric bilge pump
3	Skin fitting 3/4"
	<i>Manual bilge pump</i>
	Strainer with non-return valve
4	D25
5	Ø25 discharge hose
6	Manual bilge pump
7	Skin fitting 1"

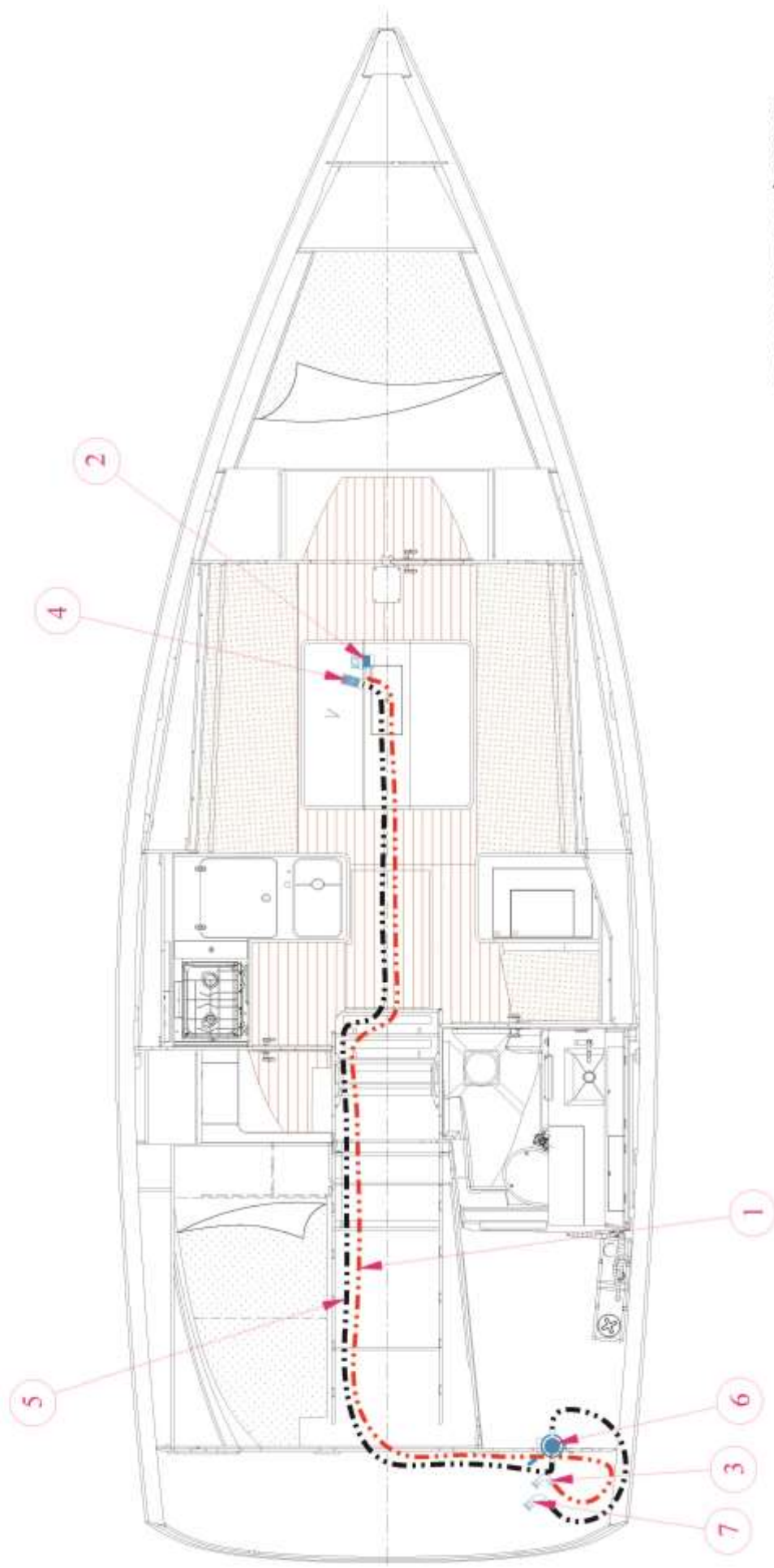

18. Skin fitting location diagram

<i>Label</i>	<i>Description</i>	<i>Ø</i>
<i>Skin-fittings + seacocks</i>		
1	Galley sink discharge	1"
2	Wash-hand basin and shower discharge	1"
3	Toilet sea-water intake	3/4"
4	Toilet discharge	2"
5	Foot pump sea water intake*	1/2"
<i>Skin-fitting</i>		
6	Electrical bilge pump discharge	3/4"
7	Manual bilge pump discharge	1"
*	Option	

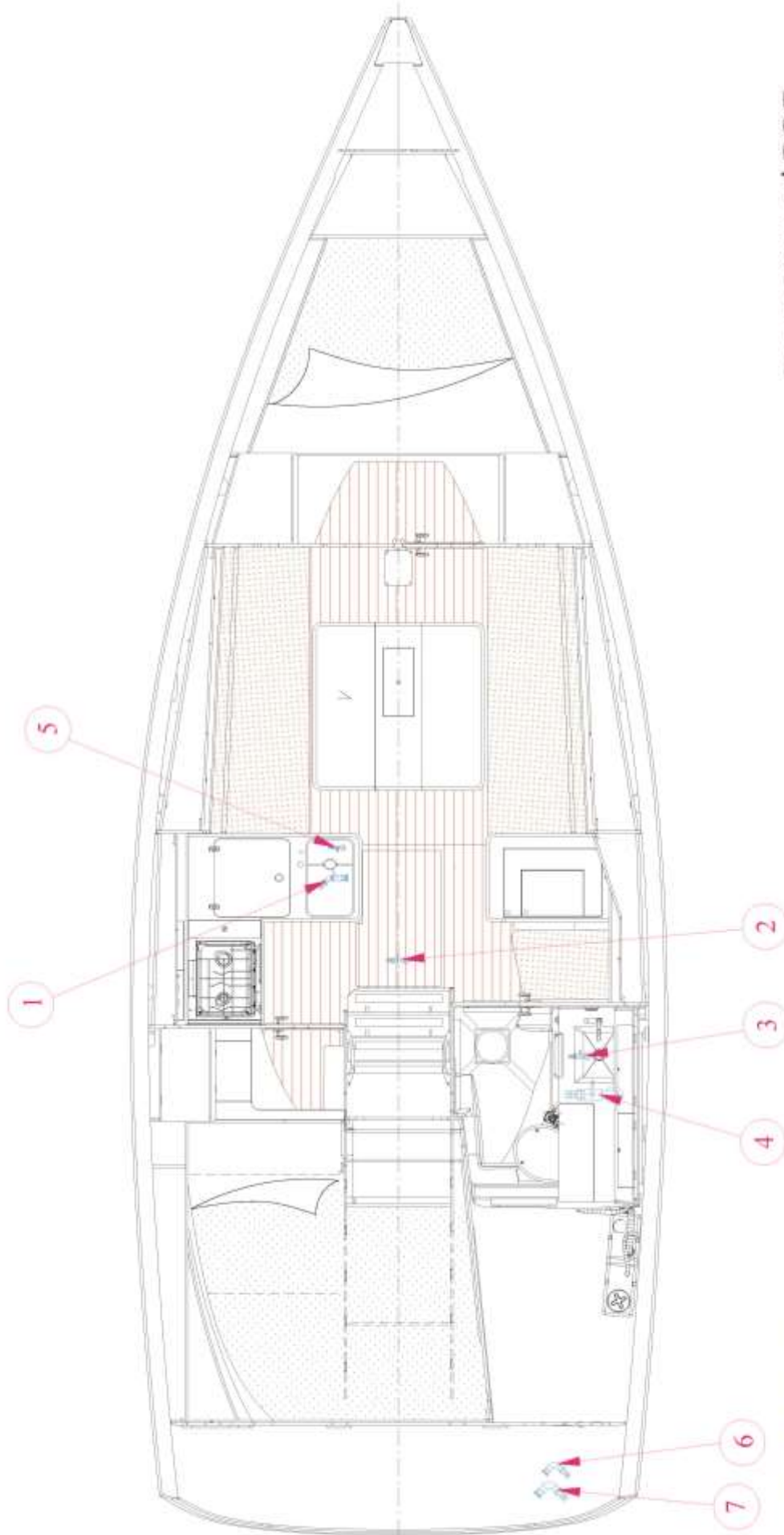

19. Mechanical installation diagram

<i>Label</i>	<i>Description</i>
	<i>General</i>
1	Engine
2	Sail-drive
3	Engine sea-water pump
4	Polyester frame
5	Isolator
6	Propeller
7	Anode
	<i>Cooling system / Exhaust system</i>
8	Sail Drive sea-water seacock
9	Exhaust pipe
10	Exhaust outlet
11	Anti-siphon swan neck
12	Water lock silencer
	<i>Fuel system</i>
13	Diesel filter with water separator
14	Fuel return hose
15	Fuel filler deck plate
16	Filler hose
17	Fuel tank vent
18	Fuel tank hose
19	Diesel tank, 160 L
20	Fuel shut-off valve
21	Fuel feed hose
	<i>Ventilation</i>
22	Port side ventilation grille
23	Starboard ventilation grille
24	Ventilation duct
25	Bilge fan
	<i>Miscellaneous</i>
26	Control cables
27	Engine battery
28	Engine controls

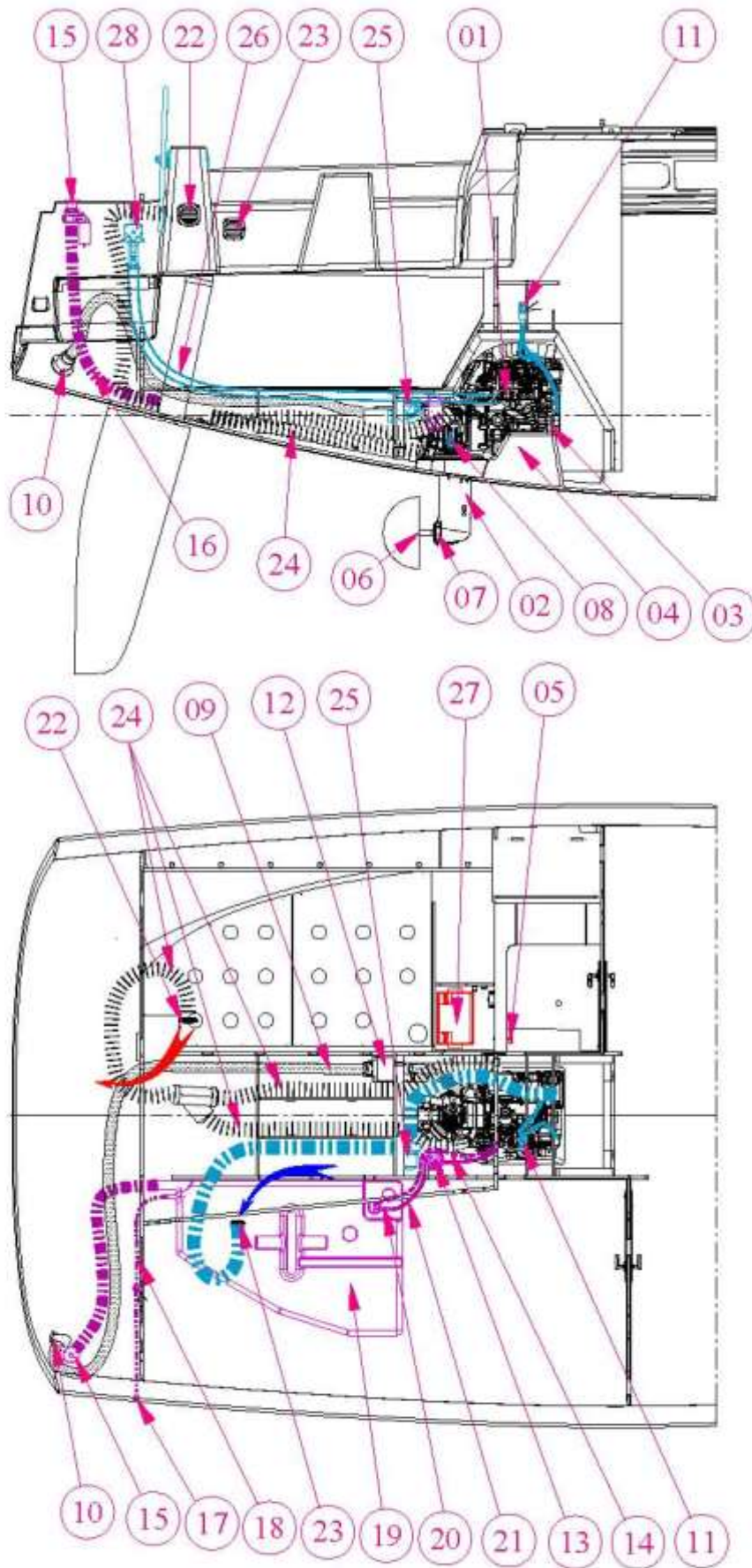

DUFOUR
YACHTS

DUFOUR|335
Grand Large (19)

20. Holding tank installation diagram

<i>Label</i>	<i>Description</i>
1	Skin fitting & seacock 3/4"
2	Waste deck plate Ø50
3	Skin fitting & seacock 2"
4	Pipe Ø20
5	Anti-odour hose Ø38
6	Anti-odour hose Ø51
7	Chromed brass vent 3/4"
8	Polyethylene holding tank 45 L
X	Swan neck

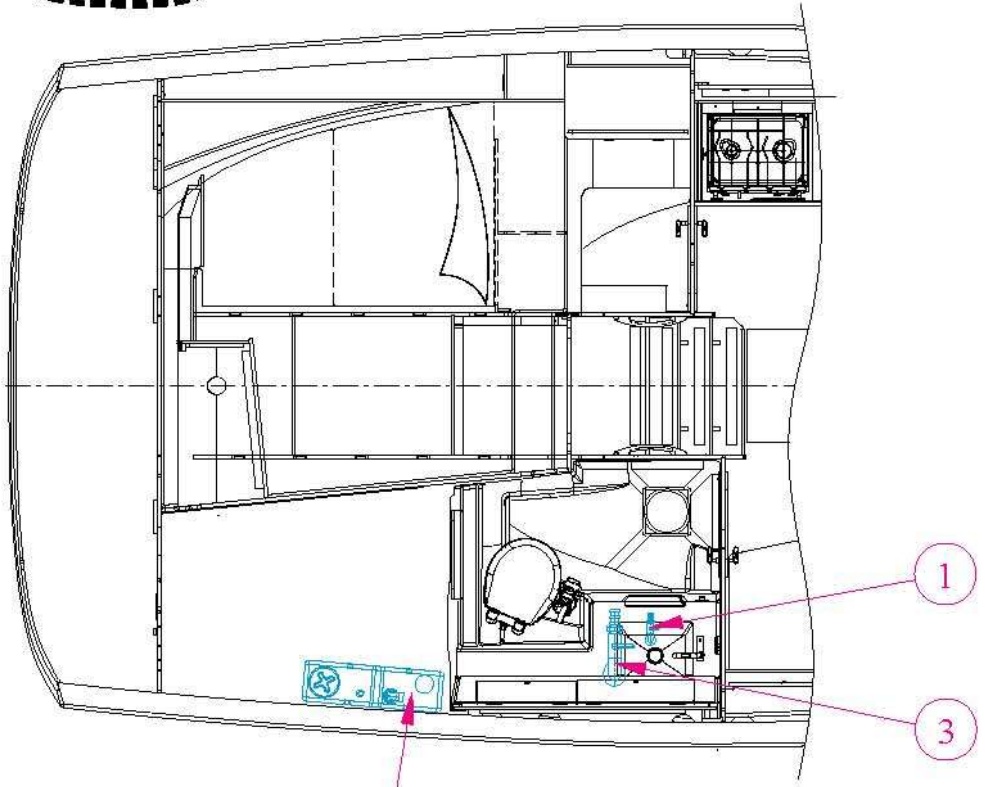
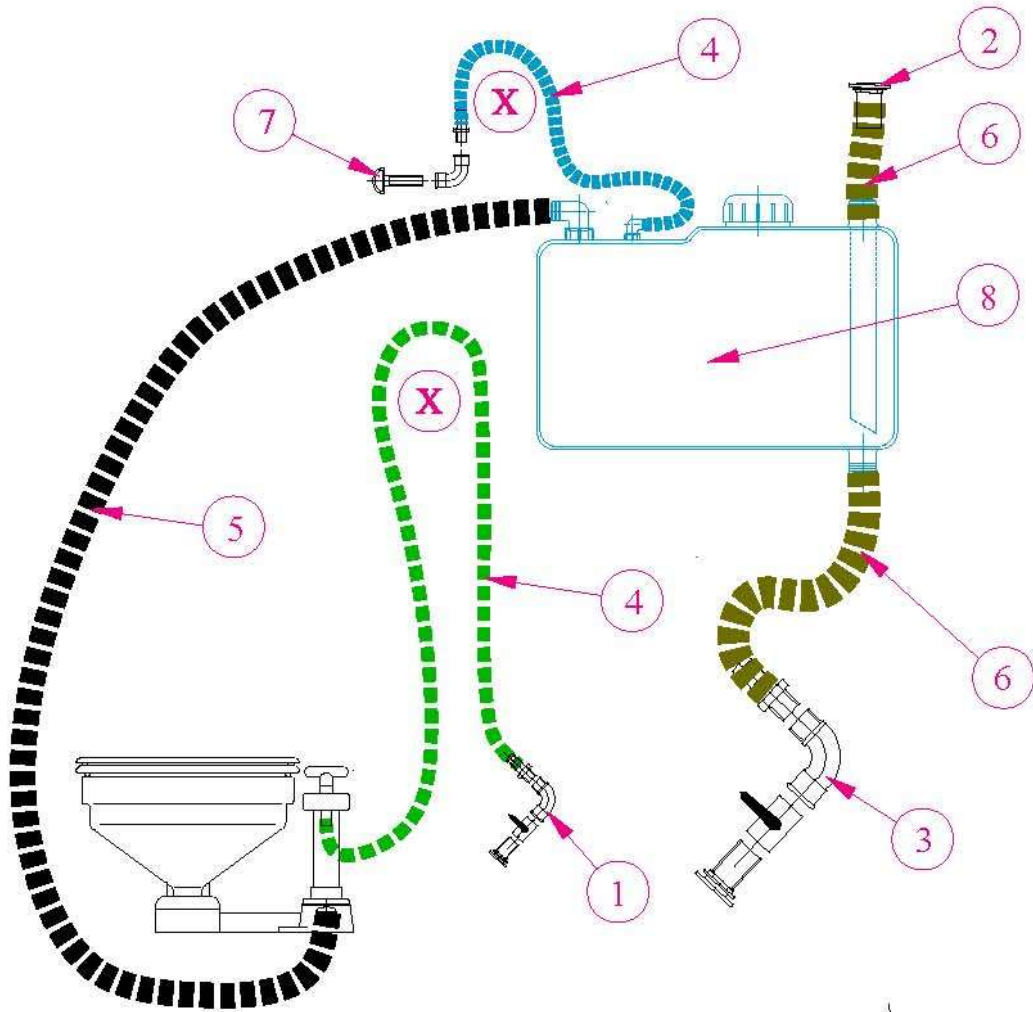

DUFOUR
YACHTS

DUFOUR|335
Grand'Large

21. Lifting diagram

<i>Label</i>	<i>Description</i>
	See red triangular marker under deck-line
	Light displacement: 5450 kg
	Max. beam 3.54 m
	Standard draught: 1.90 m

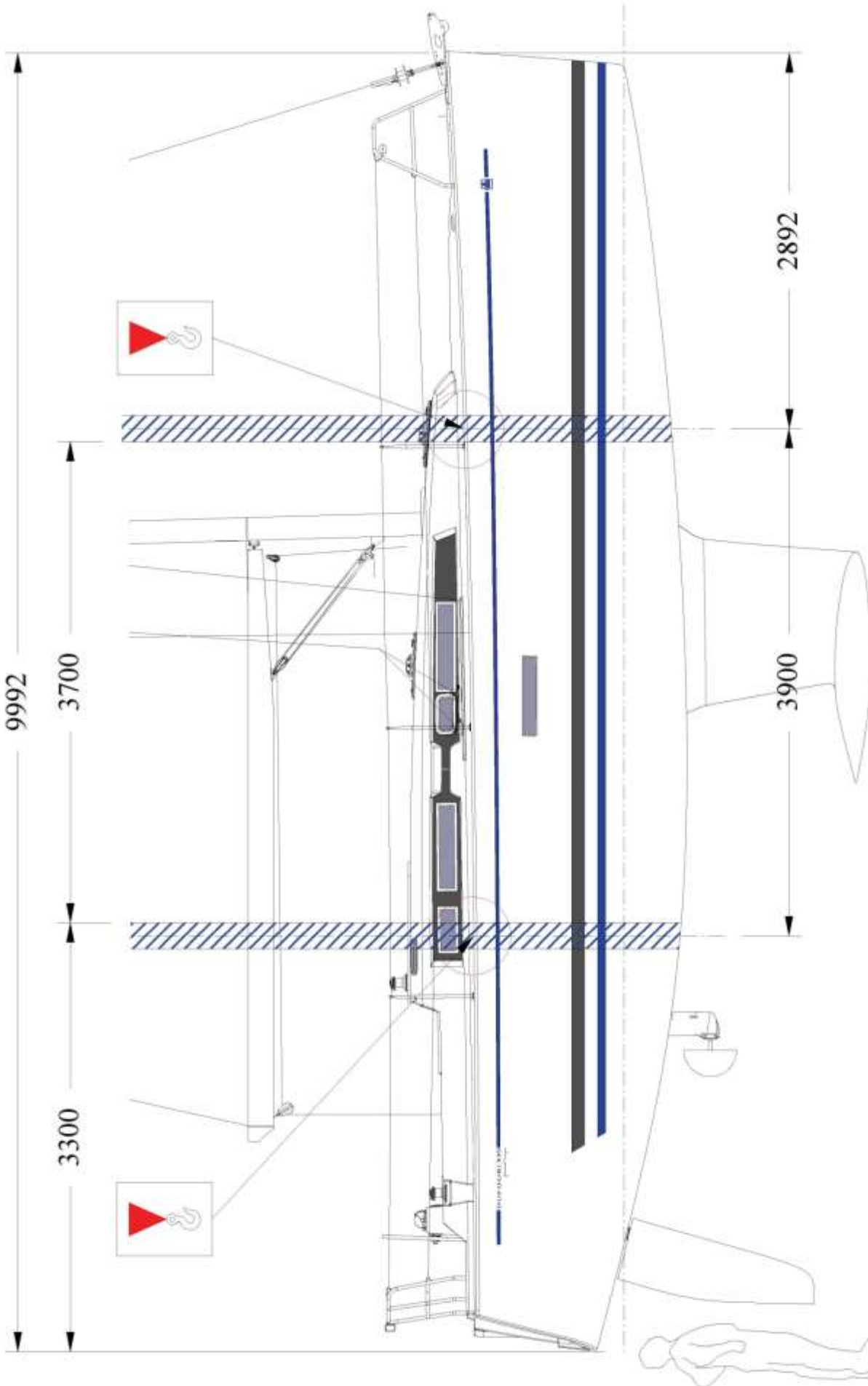

DUFOUR | 335
Grand Large 21

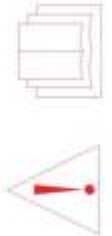

DUFOUR
YACHTS

