

# ANTARES 36

## OWNER'S MANUAL



197855 RCD-2

Index B





# CONTENTS

5	.....	Introduction	
9	.....	Technical specifications	1
13	.....	Design categories and displacement	2
17	.....	Stability and buoyancy	3
23	.....	Manoeuvrability	4
29	.....	Safety	5
43	.....	Information relating to fire risks and risks of explosion	6
51	.....	Electrical system	7
75	.....	Liquefied Petroleum Gas system (LPG)	8
83	.....	Domestic appliances	9
87	.....	Audio-visual equipment	10
91	.....	Onboard comfort	11
109	.....	Water systems	12
129	.....	Engine	13
147	.....	Steering system	14
155	.....	Deck fittings	15
167	.....	Hull fittings	16
173	.....	Handling, transport	17
179	.....	Environment	18
181	.....	Appendix	





# INTRODUCTION

## Welcome

You have just taken delivery of your new BENETEAU boat and we thank you for the confidence you have shown us in ordering a vessel of our brand. The whole BENETEAU team welcomes you aboard.

A BENETEAU is made to last, in order to bring you all the pleasure you expect from a vessel over a period of many years. Each boat is subject to the utmost attention to detail from the design stage right through to launching.

This manual is meant to help you to enjoy your boat comfortably and safely. It includes the boat specifications, the equipment provided or installed, the systems and tips on her operation and maintenance. Some of the equipment described in this manual may be optional.

Your BENETEAU dealer will be able to help and advise you in the use and maintenance of your boat. The initial commissioning of your boat will require a lot of skill and care. The proper working of all your boat's equipment is the result of the quality of the commissioning operations. This is why the initial launch must be overseen by your dealer.

**Read this Owner's Manual carefully and take the time to get to know your boat before you use it.**

**The better you know your vessel the more pleasure you will get from being at the helm.**

Keep this manual somewhere safe and should you sell your boat, hand it to the new owner.

You are advised to keep any user's guides supplied by the manufacturers of any equipment for your boat (accessories...), together with your manual.



For all the equipment on your boat, please read the instruction manuals provided by the manufacturer.

■ This manual has been produced to help you enjoy using your boat in all safety. It contains the details of the boat and of all the equipment provided and installed on your boat, as well as the instructions for their use. Read it carefully and really get to know your boat before using it.

■ This owner's manual is not in any way a navigation or mariner's training manual. If this is your first boat or if you have changed to a type of boat with which you are not familiar, make sure that you learn how to use it and manoeuvre it safely and with ease, before taking the helm alone. Your dealer, or national sailing or motorboat association, or your yacht club will be very happy to tell you about the navigation schools or qualified instructors in your area.

■ Make sure that the wind and sea conditions forecast are appropriate for the design category of your boat and that you and your crew are capable of manoeuvring the boat in these conditions.

■ Even with a well-adapted boat, the wind and sea conditions which correspond to the design categories A,B and C range from storm force winds for category A to severe storm conditions at the upper end of category C and would put the boat at risk from massive waves and extreme gusts. These are dangerous conditions in which only an experienced, fit and well-trained crew, manoeuvring a well-maintained boat, could navigate sufficiently well.

■ This owner's manual is not intended as a detailed maintenance or repairs manual. Should any problems arise please contact your dealer. If a maintenance manual is provided, please use it.

■ Always use the services of an experienced professional for the maintenance of your boat, for fitting accessories and for any modifications. Any alterations which may affect the safety specifications of the boat must be assessed, carried out and recorded by persons qualified to do so. The boat manufacturer cannot be held responsible for any modifications not approved by them.

■ Some countries require you to hold a Certificate of Competency or other qualifications, or other specific regulations may be in force.

■ Always maintain your boat well and make note of any deterioration due to wear and tear or to heavy or inappropriate use.

■ Any boat – no matter how well-built – could suffer serious damage if used recklessly. This is not compatible with safe navigation. Always adjust the speed and heading of your boat according to the sea conditions.

■ If your boat is equipped with a life-raft, read the instruction manual carefully. The crew must have available onboard all the safety gear (lifejackets, harnesses etc) appropriate for the type of boat and for the weather conditions etc.. In some countries it is mandatory to have this safety equipment onboard. The crew must be fully familiarised with the use of the safety gear and with emergency manoeuvres (Man Overboard procedures, towing another vessel etc). Sailing schools and clubs regularly run training sessions for these.

■ It is advised that, when on deck, everyone should wear the appropriate buoyancy aids (lifejackets, personal buoyancy aids) Be advised that in some countries, it is mandatory to wear a buoyancy aid which meets the national regulations at all times.

## Notes on reading this manual

The various symbols used throughout the manual for crucial safety information are as follows:



### **DANGER**

Indicates the existence of a serious inherent danger with a high risk of death or serious injury if the appropriate precautions are not taken.



### **WARNING**

Indicates the existence of a danger which could lead to injury or death if the appropriate precautions are not taken.



### **WARNING**

Indicates either a reminder of safety procedures or alerts you to dangerous manoeuvres or operations, which could result in injuries to those onboard or in damage to the boat or to components of it, or to the environment.



### **ADVICE-RECOMMENDATION**

Indicates a recommendation or advice for carrying out manoeuvres appropriate for the planned manoeuvres.

- While some of the information and illustrations in this manual may show details which are slightly different from those found on your boat, the key information remains the same. Future versions of this manual will show any possible modifications as required.
- Due to the constant desire to improve the products, SPBI S.A. reserves the right to make any changes considered necessary to the design or to the equipment. That is the reason why the specifications and information given are not contractual, they may be modified without prior notice or up dates.



- This owner's manual is written in several languages. French is the authentic reference language.
- This owner's manual was written and made up into pages by SPBI S.A.. Any reproduction of this manual, direct or indirect, provisional or permanent, by whatever means this may be, whether in whole or in part, and any modification of this manual by a third party for commercial reasons, are forbidden.



## TECHNICAL SPECIFICATIONS

■ Construction .....	10
■ General dimensions .....	10
■ Engine.....	10
■ Electricity .....	10
■ Capacities.....	11

## 1.1 CONSTRUCTION

Model.....	ANTARES 36
Architect / Design .....	Beneteau Power / Patrice Sarrazin
Builder .....	SPBI S.A
Principal means of propulsion .....	Motor
Hull and deck construction material .....	Laminated sandwich glass / GRP / Balsa wood
Hull and deck backing mould construction material .....	Single skin laminated fibreglass / GRP
Application .....	Wet laid fiber

## 1.2 GENERAL DIMENSIONS

L.O.A ( $L_{max}$ )*: with swim platform .....	11,37 m
without swim platform .....	10,32 m
<i>(Including removable parts that can be dismantled (bow roller, pulpit, bowsprit), without affecting the structure of the boat)</i>	
Hull length ( $L_h$ )* .....	9,98 m
<i>(Excluding: removable parts that can be dismantled, without affecting the structure of the boat)</i>	
Overall width ( $B_{max}$ )* .....	3,85 m
<i>(Including: removable parts that can be dismantled, without affecting the structure of the boat)</i>	
Beam( $B_h$ )* .....	3,80 m
<i>(Excluding: removable parts that can be dismantled, without affecting the structure of the boat)</i>	
Air draft - Empty vessel: .....	4,70 m
Draught - Boat fully laden:.....	0,94 m
Wetted surface area .....	Approximately 31 m <sup>2</sup>

## 1.3 ENGINE

Nominal maximum propulsion power (at the propeller shaft line) .....	2 x 212 Kw
Maximum recommended engine size.....	2 x 559 kg

## 1.4 ELECTRICITY

Circuit type: Direct current DC.....	12V
Alternating current AC .....	220V
AC (US Version) .....	110V

## 1.5 CAPACITIES

Total mass of the liquid content of fixed tanks when they are full ..... 1 184 kg

*NOTE: The density of a liquid can vary according to its temperature and quality.*

*The volume masses chosen are:*

- 0,86 kg/L for diesel fuel,
- 1 kg/L for water.

Fuel capacity: Tank 1 (*) .....	325 L
Tank 2 (*) .....	325 L
Fresh water capacity: .....	320 L
Black water capacity (WC): .....	90 L
Waste water capacity (Washbasin, Shower, Domestic appliances).....	215 L

It may not be possible to use these capacities fully depending on the trim and load of the boat. It is recommended to keep a reserve of 20% in the fuel tanks.

*(\*): Refer to the corresponding chapter to locate the position of the tank (relationship between the tank number and its position on board).*





## DESIGN CATEGORIES AND DISPLACEMENT

2

■ Design categories.....	16
--------------------------	----

- Some of the data is shown on the manufacturer's plate fixed to the boat. The explanation of the data is given in the appropriate chapters of this manual.

Design category	<b>B</b>	<b>C</b>	<b>D</b>
Maximum number of people to be allowed onboard (CL)*	<b>10</b>	<b>12</b>	<b>12</b>
Maximum number of people to be allowed on the flybridge	<b>6</b>	<b>6</b>	<b>6</b>
Light displacement (MLC)**	<b>7 272 kg</b>		
Recommended maximum load (ML)***	<b>3 030 kg</b>	<b>3 070 kg</b>	<b>3 070 kg</b>
Displacement with maximum load (MLDC)****	<b>10 302 kg</b>	<b>10 342 kg</b>	<b>10 342 kg</b>

**NOTE:** *The on-board fitted options are included in the maximum load. The more options the boat has, the less room there is for provisions or personal belongings.*

#### DEFINITION:

\* **CL:** Crew Limit

\*\* **MLC:** Mass of the boat in Light Craft Condition includes the weight of the boat in the standard ready-to-navigate version, ballast, standard equipment, engine(s), sails (if the boat is a sailing boat).

\*\*\* **ML:** Maximum Load

- The recommended maximum load includes the weight of all the people onboard, of provisions, personal belongings, of all equipment not included in the weight of the boat in ballast, of the cargo (if relevant) and of all liquids contained in fixed tanks when full (fuel, water, grey water, black water).

- The maximum recommended weight shown on the manufacturer's plate does not include the weight contained in the fixed tanks of liquid when full (fuel, water, grey water, black water).

\*\*\*\* **MLDC:** Mass of the boat in Maximum Load Condition  
Includes light ship mass MLC + maximum load ML.

If some of those onboard are children, the total number of people allowed onboard may be increased, provided that:

- The total weight of the children does not exceed 37,5 kg;

and that

- the total weight of all allowed onboard (based on about 75 kg per adult) is not exceeded.



- Do not exceed the recommended maximum number of people onboard. However many people are onboard, the total, combined load of people and any gear or equipment must never exceed the recommended maximum load.
  - Always use the seats or seating areas provided.



- When loading the boat, never exceed the recommended maximum load. Always load the boat with care and distribute the loads in order to maintain the theoretical trim (more or less horizontal).
  - Avoid placing heavy loads high up in the boat.

## 2.1 DESIGN CATEGORIES

### Category A:

A yacht of design category A is considered to be designed for wind that may exceed force 8 (on the Beaufort scale) and waves that can exceed a significant height of 4 metres, but excluding exceptional conditions such as storms, severe storms, tornadoes and extreme sea conditions or huge waves.

### Category B:

A yacht of design category B is considered to be designed for wind that may go up to force 8 inclusive and waves that can reach a significant height up to 4 metres inclusive.

### Category C:

A yacht of design category C is considered to be designed for wind that may go up to force 6 inclusive and waves that can reach a significant height up to 2 metres inclusive.

### Category D:

A yacht of design category D is considered to be designed for wind that may go up to force 4 inclusive and waves that can reach a significant height up to 0,3 metres inclusive, with occasional waves of a maximum height of 0,5 metres.

***NOTE: Boats in each category must be designed and built to withstand these parameters in respect of stability, buoyancy, and other relevant essential requirements and to have good handling characteristics.***

## STABILITY AND BUOYANCY

- Stability data ..... 18
- Access to the boat..... 19

### 3.1 STABILITY DATA

- Fully laden displacement was used to evaluate the stability and buoyancy of the boat. The value of this displacement can be found in paragraph "Technical specifications" at the beginning of this manual.
- Any changes in the distribution of loads onboard (for example by adding a raised structure for fishing, fitting a radar or in-mast furling, changing the engine etc.) can significantly affect the boat's stability, trim and its performance;
- It is important to keep water in the bilges to a minimum;
- The boat's stability is affected by adding to the weight of the superstructure;
- In heavy weather it is important to close all the hatches, lockers and doors to minimise the risk of water pouring in;
- The boat's stability can be reduced when towing a boat or when using a davit or boom to lift a heavy load;
- Breaking waves are a serious threat to stability.



- Reduce speed in waves.
- Always adjust the speed and heading of your boat according to the sea conditions.
- All of the watertight hatches must remain closed when at sea.
- Beyond 20 knots of Wind, you are advised to stow all removable protection sheets (Bimini, Covers, ...).

## 3.2 ACCESS TO THE BOAT

### Access to the cockpit

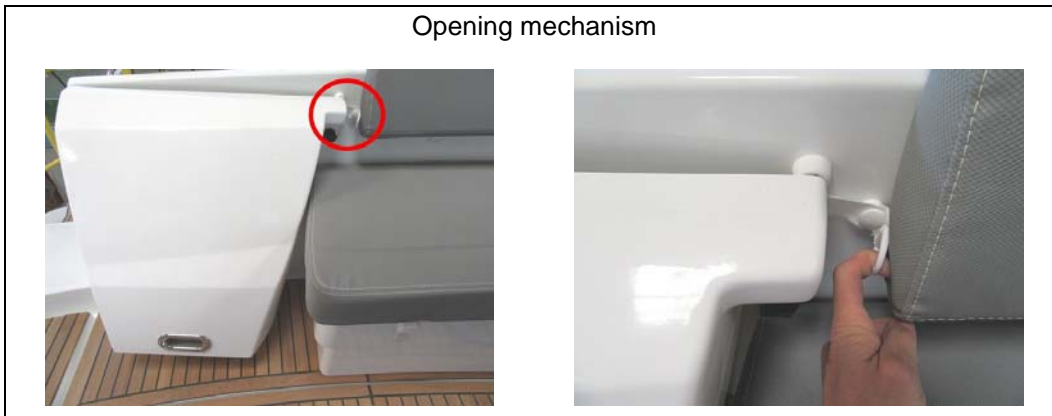

- ✘ It is imperative that both the cockpit and the engine compartment are kept closed when at sea.
- When at sea close the guardrail side-opening or openings.
- Slamming an access hatch may cause injury : always close the hatch gently and carefully.
- Do not allow children to open or close the hatches unsupervised.

- ! It is imperative that the access doors to the saloon are kept closed when at sea.
- Close the deck hatches and portholes before each trip.
- Close all access doors and hatches in heavy weather or when the sea is rough.

- 🟢 When under way, keep hull valves and fillers in the closed position to minimise the risk of flooding.

## Access to the engine compartment

Saloon



Aft cabin





**Access to the flybridge**



**Direct access to cockpit locker**

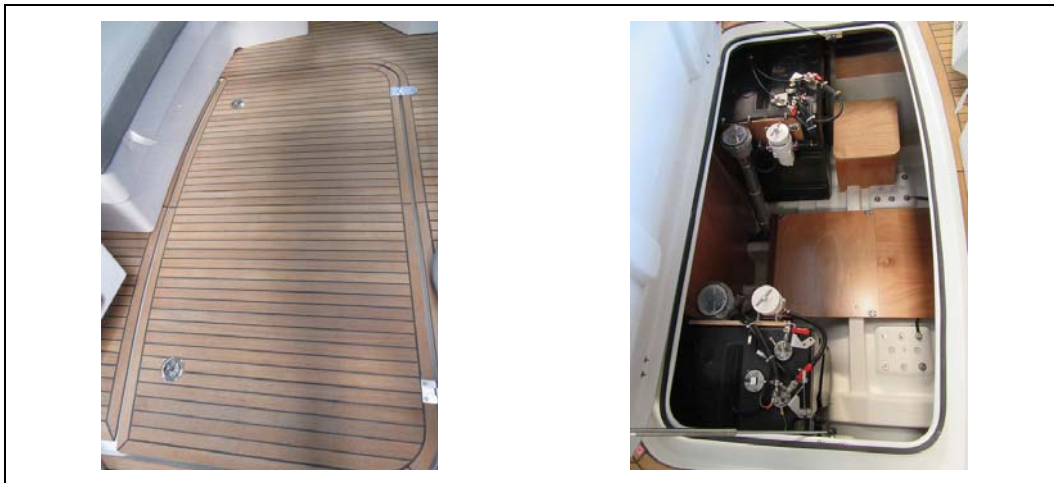

## Access to the saloon



## MANOEUVRABILITY

■ Visibility from the steering station..... 25

- It is important to take additional precautions in very strong winds or in a confused sea or breaking waves.
- Do not install an engine in this boat with a higher rated power than that indicated on the manufacturer's plate.
- Do not drive the boat at high speed with a negative trim of the propulsion equipment (bow down). This can make the boat heel and cause it to be unstable when turning. Use a negative trim to make the transition from displacement speed to planing speed, and at lower speeds in choppy seas (applicable to boats equipped with a system for directing the propeller thrust).
- Do not drive at top speed in areas of heavy boat traffic or in situations of reduced visibility, strong winds or heavy seas. Reduce the boat's speed and wake out of courtesy and for your own safety and the safety of others. Observe speed limits and "NO WASH" signs.
- Observe the rules of right of way as they are defined by the rules and required by international regulations to prevent collisions at sea (RIPAM / Col Reg).
- Ensure that you always have sufficient room to stop or manoeuvre if necessary in order to avoid a collision.
- Avoid abrupt manoeuvres at full speed.
- Do not sit on the forward section of the cockpit when the boat is moving at high speed.
- Reduce speed in big waves for your comfort and safety.

#### 4.1 VISIBILITY FROM THE STEERING STATION

The view of the helmsman from the helm station can be obstructed by the boat heeling significantly or because of other factors caused by one or several of the following variable conditions:

- 1) Adjustment angle of the propulsion system (trim) (On boats equipped with an engine push angle regulator);
- 2) Angles of level control flaps (On boats fitted with level control flaps, powered or fixed, installed on the transom);
- 3) Load and load distribution;
- 4) Speed;
- 5) Rapid acceleration;
- 6) Transition from displacement mode to planing mode;
- 7) Sea conditions;
- 8) Rain and mist;
- 9) Darkness and fog;
- 10) Lights inside the boat;
- 11) Position of covers and curtains;
- 12) Persons or mobile equipment located in the helmsman's field of view.

The international regulations to avoid collisions at sea (Col Reg / RIPAM) and rules require appropriate and continuous watching as well as the observance of the right-of-way rules. Observance of these rules is essential.

Two helm stations are fitted on the boat:

- main helm station in the saloon,
- secondary helm station on the flying bridge.

**NOTE: Some functions or commands are only accessible from the main helm station.**



- Manoeuvrability is reduced at excessive speeds.
  - There is a risk of loss of control during tight turns.
  - Reduce speed before making a turn in any direction.
- The visibility of the inside helm station is reduced on the stern of the boat: Please keep the necessary watch.

#### 4.1.1 Wiper

The windscreen wipers run on DC power.

Control: Steering station

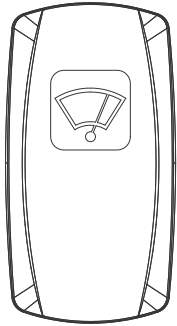

Engine access: Deckhead (Forward cabin)



Location:



#### 4.1.2 Windscreen washer

Control: Steering station

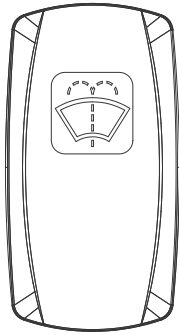

Reservoir location:  
Saloon (Starboard bench seat)



#### 4.1.3 Horn

The foghorn runs on DC power.

Control: Steering station

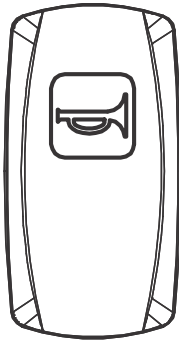

Location:



#### 4.1.4 Navigation lights

The navigation lights run on DC power.

Control: Steering station

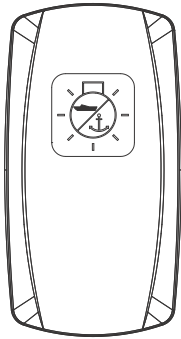

Mooring light



The only function of the samson post is to support the navigation light. Any other use is dangerous and forbidden.



## SAFETY

- Preventing man overboard situations and the means of getting someone back onboard ..... 30
- Storing the life-raft ..... 33
- Securing moveable items ..... 34
- Information about the risks of flooding and about the boat's stability ..... 35
- Emergency systems in case of steering gear failure..... 42

## 5.1 PREVENTING MAN OVERBOARD SITUATIONS AND THE MEANS OF GETTING SOMEONE BACK ONBOARD

### 5.1.1 Prevention of man overboard

- The off-limits areas of the working deck when the boat is under way are cross-hatched below



- The "working deck" means those areas outside where people stand or walk during normal use of the boat.

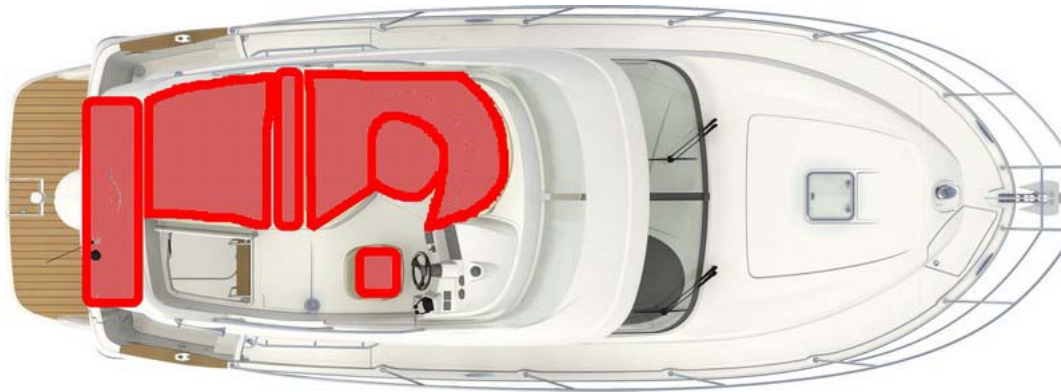

Use the seats provided.



Ref 1 & 1': Fitting a means of climbing back onboard.

Ref 2: Mooring cleats.

Regularly check the guard-rails:

- With metal guard-rails, watch for corrosion particularly at connecting points.
- With synthetic guard-rails, change them as soon as they show signs of wear due to chafing or UV.

## 5.1.2 Getting back onboard

The means for getting back onboard must be able to be deployed by one person alone in the water, with no other help.

Installation of means to get back on board when swimming:  
Swimming ladder (Ref 1):

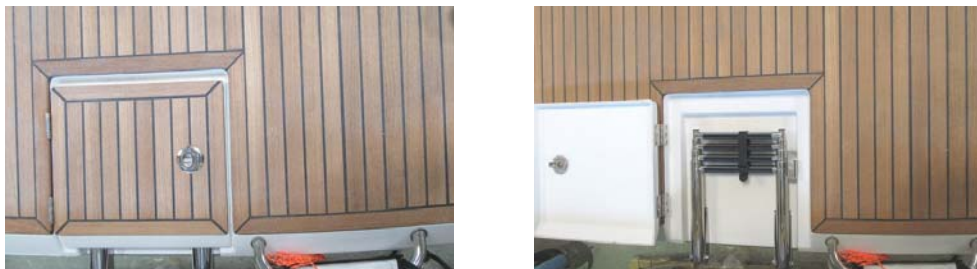

Installation of means to get back on board in the event of an accidental fall (Ref 1):



Assembling the ladder:

- Adjust the length of the cord to reach the water level and check that the ladder is properly released. It is important to ensure that the ladder extends smoothly into the water. Finally stow away the ladder and close the internal flap with press studs.



- Some types of equipment for getting back onboard have a locking device when folded up: It is important to keep the means for getting back onboard deployed and ready to use once the boat is in use (at anchor, moored or at sea).
- Make sure that the means for getting back onboard are readily accessible and easy to use by someone alone in the water.
- Before using your boat, make sure the safety ladder is in its place.



- Make sure your safety ladder is installed in accordance with the installation diagram.
- Make sure the triggering line is installed in accordance with the installation diagram.

### AVERTISSEMENT

Veillez à ce que l'échelle souple soit installée conformément aux instructions du Manuel Propriétaire. Veillez également à ce que le bout déclencheur soit mis à poste conformément aux instructions.

### WARNING

Make sure that the flexible ladder is installed as specified in the Owner's Manual. Also make sure that the rope trigger is installed in accordance with the instructions.

## 5.2 STORING THE LIFE-RAFT



The life-raft(not supplied) must be stored in the space provided for it (Ref 1). A pictogram helps to locate it easily.



- ! - Before putting to sea, carefully read the launching instructions shown on the liferaft.
- When at sea, never padlock or lock the stowage locker for the life-raft.

### 5.3 SECURING MOVEABLE ITEMS

The technical areas are identified in the boat by the pictogram below:



The electrical technical areas are identified in the boat by the pictogram below:



Technical areas may not be used as storage compartments.



- Ensure that movable items are firmly secured when the boat is under way.
- Don't store anything below the floorboards.

## 5.4 INFORMATION ABOUT THE RISKS OF FLOODING AND ABOUT THE BOAT'S STABILITY

### 5.4.1 Openings in hull

The valves, through-hull and other brass accessories last for about 5 years. Have all valves, hull orifices and other brass accessories of the vessel professionally checked every 5 years and replace them as necessary.

TOP VIEW OF HULL

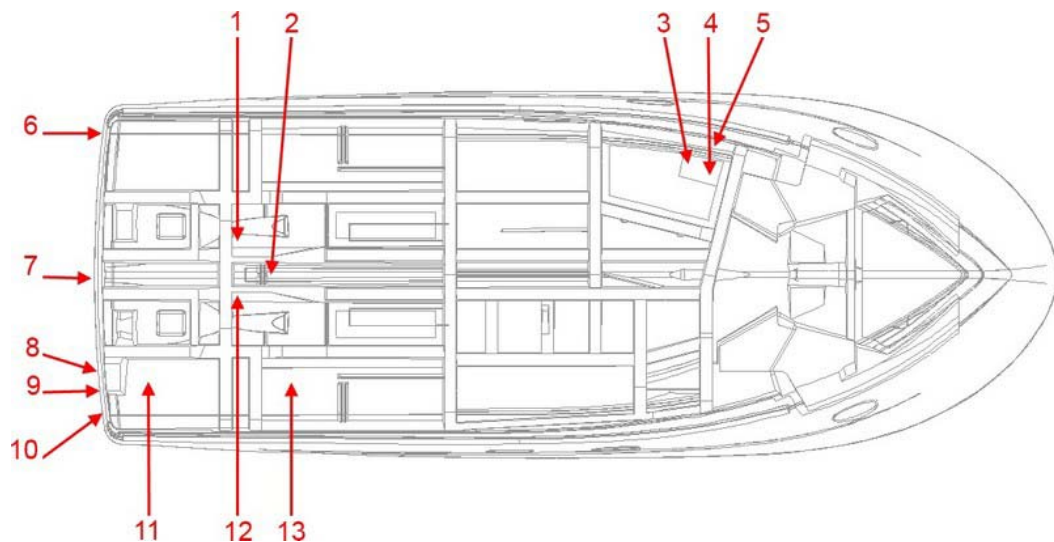

Reference	Designation	Valve
1	Port engine seawater intake	Yes
2	Generator seawater intake	Yes
3	WC seawater intake	Yes
4	Black water drainage tank (WC)	Yes
5	Head washbasin evacuation	Yes
6	Cockpit scupper	Not
7	Anode	Not
8	Air conditioning condensation drain	Yes
9	Wheelhouse compressor drain	Yes
10	Cockpit scupper	Not
11	Air conditioning seawater intake	Yes
12	Starboard engine seawater intake	Yes
13	Electronic sensor	Not



**VIEW OF HULL, STARBOARD SIDE**

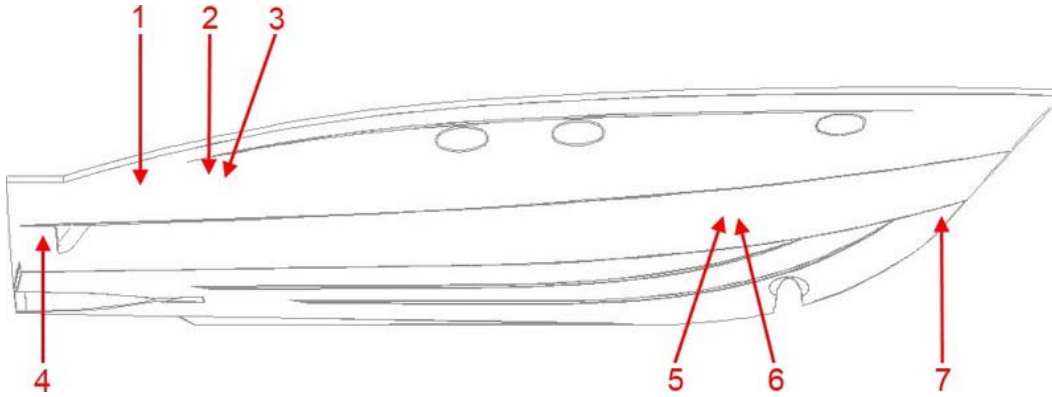

Reference	Designation	Valve
1	Draining of manual bilge pump	Not
2	Port side fuel tank vent	Not
3	Starboard fuel tank vent	Not
4	Port engine exhaust	Not
5	Air conditioning condensation drain	Yes
6	Cabin compressor drain	Yes
7	Chain locker scupper	Not

**VIEW OF HULL, PORT SIDE**

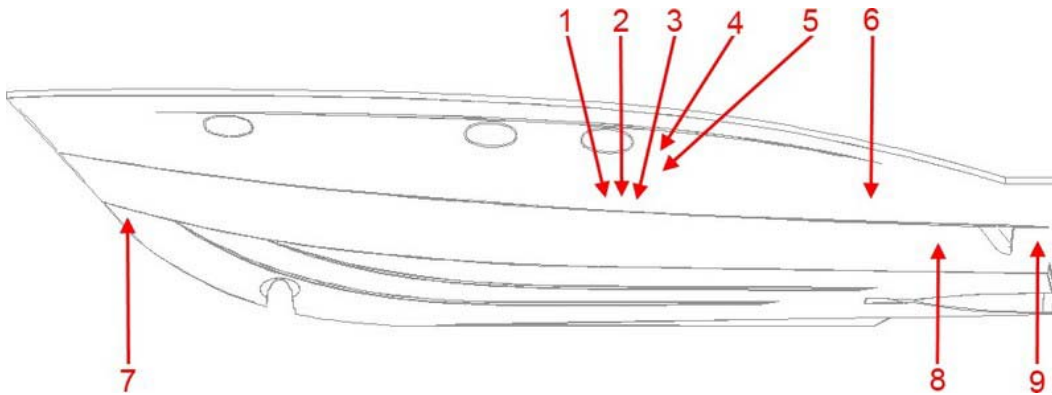

Reference	Designation	Valve
1	Electric bilge pump draining	Not
2	Electric bilge pump and galley sink drain	Not
3	Shower draining	Not
4	Water tank vent	Not
5	Black water drainage tank (WC)	Not
6	Gas locker drain	Not
7	Chain locker scupper	Not
8	Generator exhaust	Not
9	Port engine exhaust	Not



## 5.4.2 Drainage system

### General points

- The inner moulding of the hull has channelling: the drainage channels. The drainage channels allow the water to drain down to the lowest point in the boat, where it can be discharged. So it is important to allow the water to flow freely down to this lowest point of the boat, which includes.
- Regularly cleaning the lowest point of the boat and the drainage channels.

**DIAGRAM OF THE LAYOUT - DRAINAGE CHANNELS**

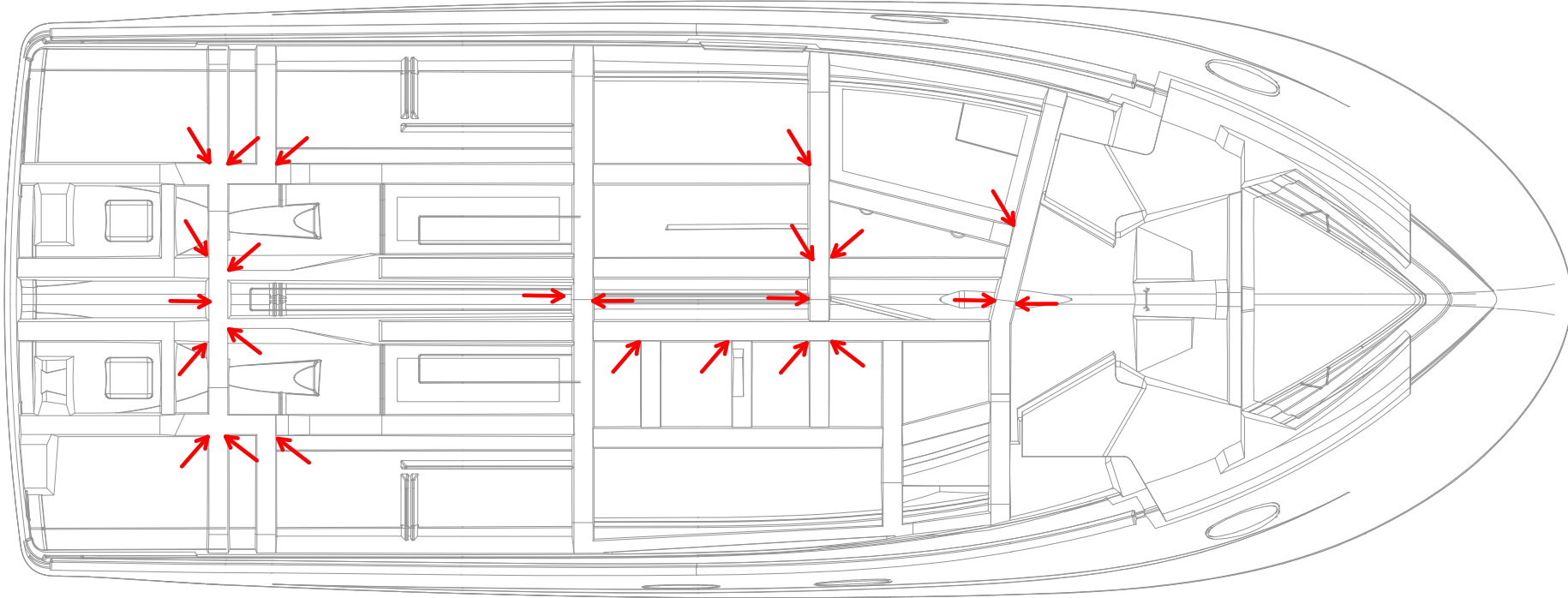

## DIAGRAM OF THE LAYOUT - BILGE PUMPS

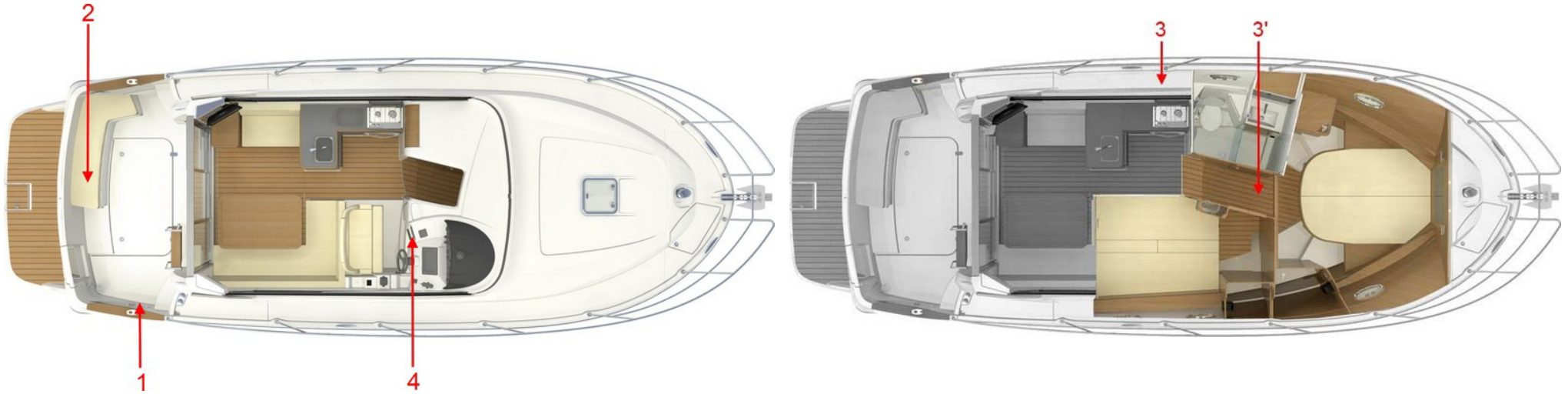

Reference	Designation	Rate
1	Manual bilge pump	32 L/minute (*)
2	Manual bilge pump lever	
3	Electric bilge pump	20 L/minute
3'	Electric bilge pump	129 L/minute
4	Electric bilge pump switch	

(\*) 45 strokes/minute

## Secondary drainage system Manual bilge pump



The manual bilge pump is in the cockpit (Ref 1).



The bilge pump lever is located close to it (Ref 2).



### Operation:

- I- Put the lever on the manual bilge pump.
  - II- Repeatedly work the lever up and down to its fullest extent.
- The manual bilge pump lever must remain accessible at all times.

## Main drainage system Electric bilge pumps

- The bilge pumps are powered by DC.
- Location of the electric bilge pumps:

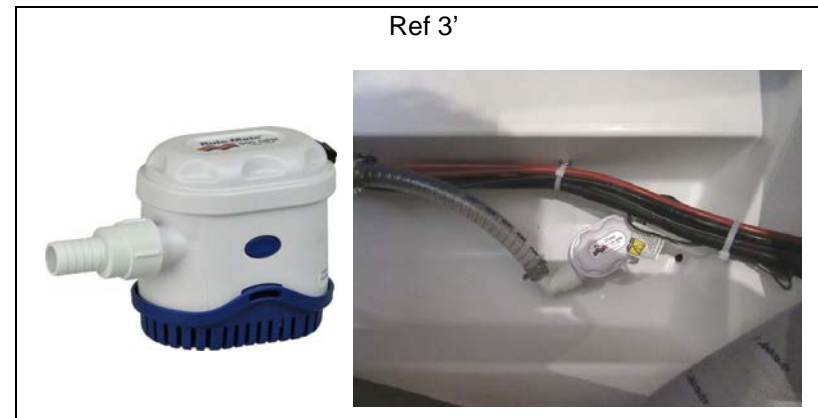
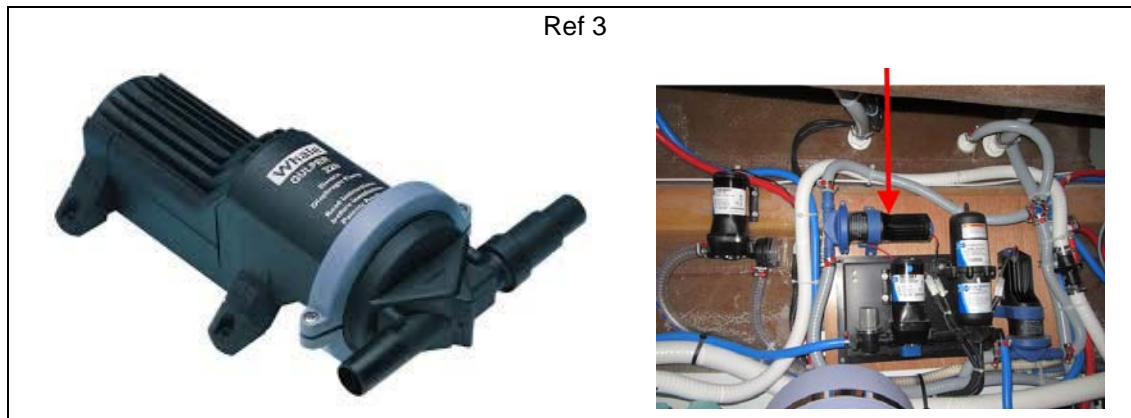

- The electric bilge pump switch is located at the helm station (Ref 4).

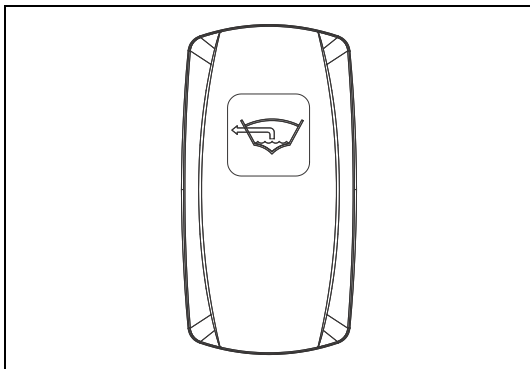

- The electric bilge pump must only be used to discharge stagnant water at the bottom of the bilge. It must not be used to pump out any oil-based products (petrol, oil) or inflammable liquids.

### Operation:

- I- Turn on the battery switches.
- II- Switch on the bilge pump (Ref 4).

If the boat is equipped with an automatic bilge pump, the switch has an always-on position.

## Bilge pump maintenance

Please refer to the manufacturer's notes on the instructions for checking and maintaining the bilge pumps.

**DIAGRAM OF THE LAYOUT - DRYING OUT THE BILGE**

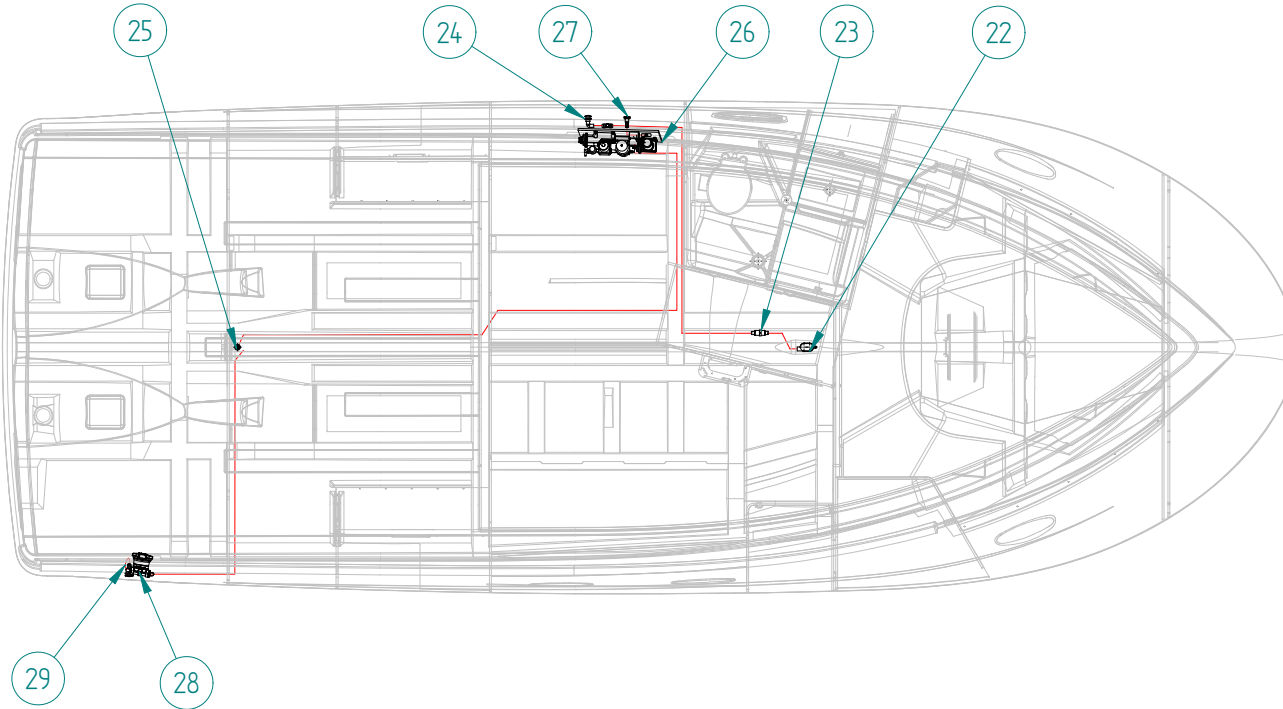

Reference	Designation
22	Electric bilge pump
23	Non-return valve
24	Bilge pump draining
25	Stuffing box
26	Electric bilge pump
27	Electric bilge pump draining
28	Manual bilge pump
29	Draining of manual bilge pump

- !**
- The drainage system is not designed to control water coming from breaches in the hull.
  - Keep the water level in the bilges to the minimum.
  - Never store anything right at the bottom of the boat: Allow bilge water to flow freely down to the lowest point of the boat.

- !**
- Check that each bilge pump is working at regular intervals.
  - Clear the bilge pump points or strainers of any debris that could clog them.
  - If the watertight partitions which seal off the fore and aft points are fitted with valves they must be closed at all times and only opened to drain water into the main bilge.

## **5.5 EMERGENCY SYSTEMS IN CASE OF STEERING GEAR FAILURE**

### **INSTRUCTIONS IN THE EVENT OF STEERING GEAR FAILURE**

On a twin-engined vessel the emergency tiller system works on the difference in drive between the port and starboard engines (difference in throttle and/or forward/aft).

## INFORMATION RELATING TO FIRE RISKS AND RISKS OF EXPLOSION

■ Propulsion engines and other fuel-burning equipment.....	44
■ Electrical system .....	44
■ Gas system .....	44
■ Fire-prevention and fire-fighting equipment.....	45
■ Emergency exits in case of fire.....	49

## 6.1 PROPULSION ENGINES AND OTHER FUEL-BURNING EQUIPMENT

 The risks associated with motorisation are described in the ENGINE chapter.

### Note concerning the boat's tender:

- If the tender is fitted with a more powerful outboard motor than 25 Kw, it must have on board a portable extinguisher with a rating equal to or greater than 8A / 68B.
- Place for storing the petrol tank of the tender: on deck.

 The risks associated with other fuel-burning equipment are described in the EQUIPMENT OTHER THAN FOR PROPULSION, WHICH BURNS FUEL chapter.

## 6.2 ELECTRICAL SYSTEM

 The risks associated with the electrical systems are described in the ELECTRICITY chapter.

## 6.3 GAS SYSTEM

 The risks associated with the gas system are described in the GAS chapter.



## 6.4 FIRE-PREVENTION AND FIRE-FIGHTING EQUIPMENT

### 6.4.1 Fire-fighting equipment

#### **Portable fire-extinguishers and fire blanket (not supplied)**

- When in use, this boat must be equipped with portable fire extinguishers of the following extinguishing capacity and located in the following places:



Location	Minimum extinguishing capacity
Cockpit locker	5A / 34B
Saloon seating	5A / 34B

- The location of the portable fire extinguishers is shown by the pictogram below:



- When in use, this boat must be equipped with a fire blanket to protect the cooking equipment and/or the galley, installed in the following place: near the cooking equipment.

## **Maintenance of the fire-fighting equipment**

The owner/person operating the boat must:

- Get the fire-fighting equipment checked at the frequency shown on the equipment;
- Replace portable fire extinguishers, if outdated or discharged, by extinguishing apparatus of equal capacity;
- Provide at least one fire bucket with a lanyard, in a readily accessible place, for protection on deck;
- Get the fixed fire extinguishing systems filled or replaced if they are discharged or have expired.

## **Responsibility of the owner/boat operator**

It is the responsibility of the owner/boat operator to:

- Ensure that the fire-fighting equipment (portable extinguishers, bucket and fire blanket) is readily accessible when there are people onboard;
- Ensure that the engine compartment fire extinguisher discharge port is readily accessible;
- Show the members of the crew:
  - The location and use of the fire-fighting equipment;
  - The location of evacuation routes and fire exits.
- Equip the vessel with one or more portable extinguishers whose heads are compatible with the diameter of the discharge orifice in vertical use.
- Unlock all deck hatches and fire escape openings when the vessel is occupied.

## **Notes for the attention of the boat user**

### General points

- Check that the bilges are clean and frequently check that there are no fuel/gas vapours or fuel leaks.
- In the case of replacement of components of the fire-fighting equipment, use only the appropriate components of the same code designation or having the equivalent technical capacity and fire resistance.
- Do not install free-hanging curtains or other fabrics near or above the cooking appliances or other equipment with a naked flame.
- Do not store combustible materials in the engine compartment. If non-combustible materials are stored in the engine compartment they must be secured so there is no danger of them falling on machinery and they do not obstruct access to and from the compartment.
- The fire exits other than the door or main companionway are identified by the following symbol:



#### 6.4.2 Fixed extinguishing system with manual control

- This boat is fitted with a fixed fire extinguishing system protecting the engine compartment.
- Procedure to follow in the event of fire in the engine compartment:
  - Stop the engine and fan,
  - Switch off power and stop fuel supply,
  - Close access to the compartment,
  - Pull the extinguisher remote control for 20 seconds,
  - Wait,
  - Ventilate the compartment after the fire has been extinguished,
  - Open the access hatches and repair.



**To enable functioning of the fixed fire extinguishers, the safety pins on each extinguisher must all be removed completely.**



- To avoid suffocation, leave the area before discharge. After discharge, ventilate before entering. After discharge, ventilate before entering.
- Refer to the manufacturer's instructions for use and maintenance.

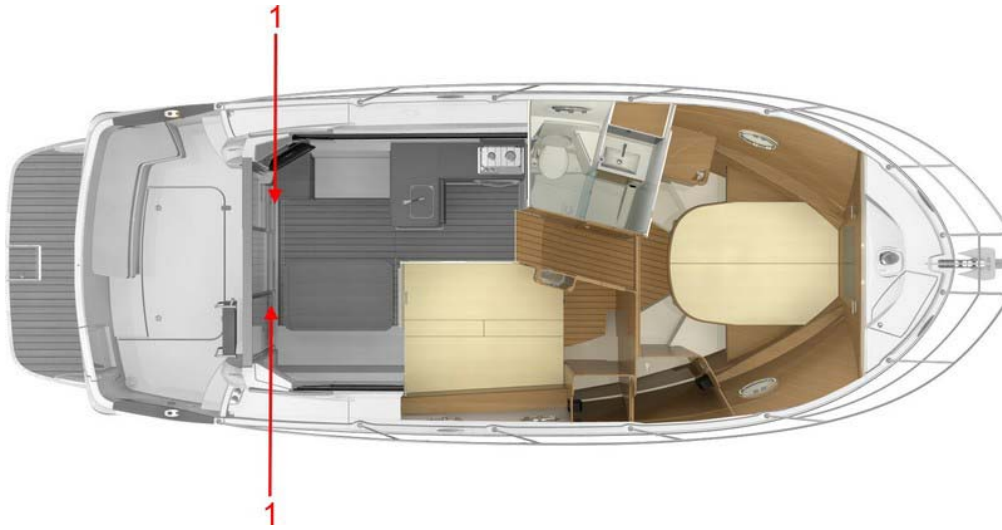

Ref 1: Fixed extinguisher  
Location: Engine compartment



Ref 2: Remote pull switches  
Location: Steering station



The position of the remote control handles is indicated by the pictogram shown below:



## 6.5 EMERGENCY EXITS IN CASE OF FIRE

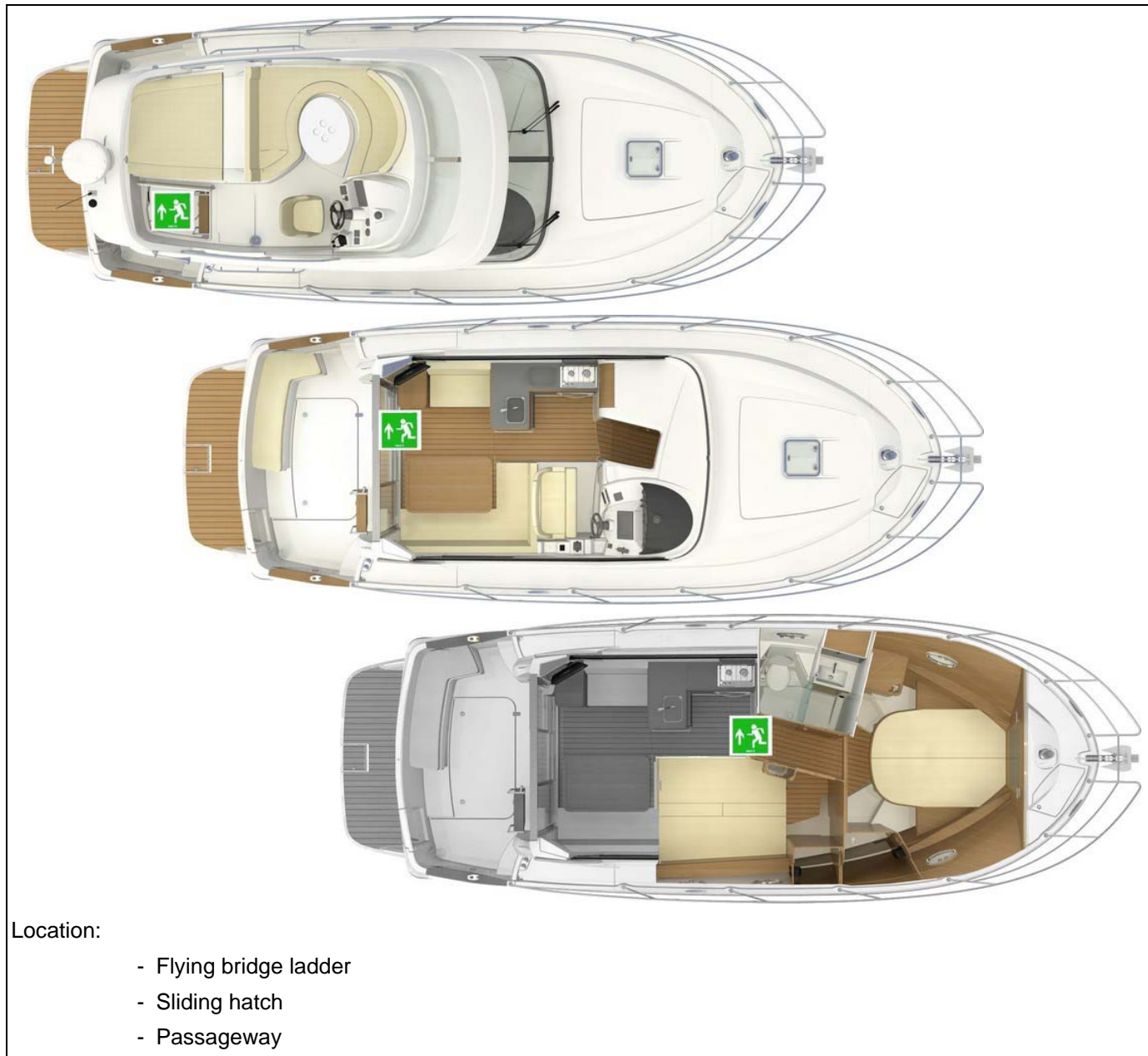

### NEVER:

- Obstruct the passages leading to the emergency exits and the hatches;
- Obstruct or block safety controls, for instance fuel shut off valves, gas taps, electrical system circuit-breakers;
- Obstruct the access to the portable extinguishers stored in lockers;
- Leave the boat unsupervised when cooking equipment and/or heating equipment is in use;
- Modify any of the boat's installations (especially the electrical, fuel or gas installations) or allow unqualified personnel to proceed with modifying these installations;
- Fill the fuel tanks or replace gas bottles while the engine is running or while cooking or heating equipment is in use;
- Use gas lamps in the boat;
- Smoke when handling fuel or gas.



## ELECTRICAL SYSTEM

■ General information about the electrical system .....	52
■ DC installation (12V or 24V).....	53
■ AC system (110V or 220V) .....	67
■ Protection against electrolysis / Earth plate.....	72



## 7.1 GENERAL INFORMATION ABOUT THE ELECTRICAL SYSTEM

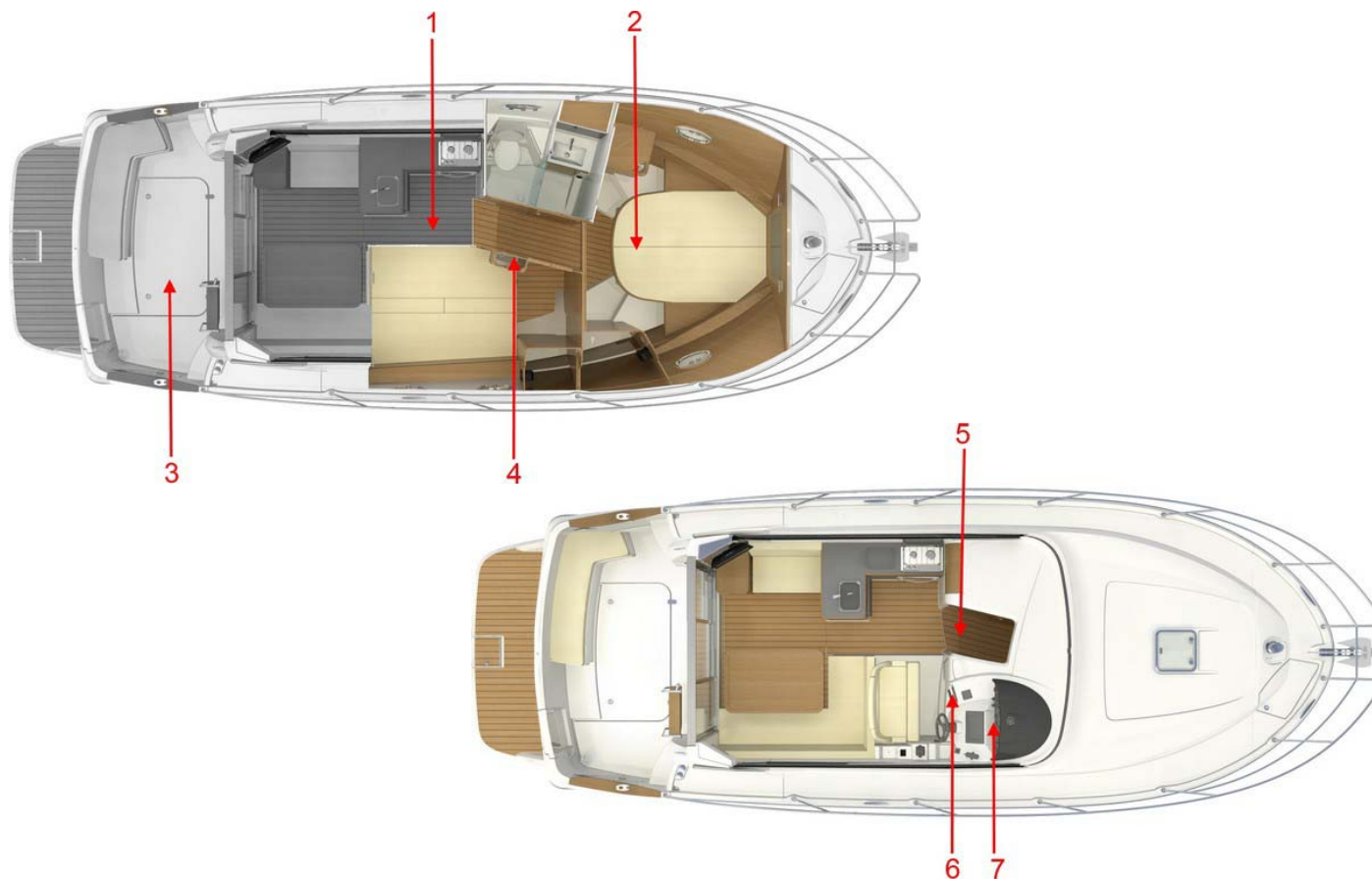

Reference	Designation
1	Technical locker (Service batteries, Engine batteries, DC breakers, Battery charger, Load distributors, Relay box)
2	Bow thruster batteries
3	Generator battery
4	Electric cupboard (Fuses)
5	Battery switch
6	Steering station switches
7	Fuses (Behind the wheelhouse)

**⚠**

- The risks of fire or explosion may result from careless use of the DC and AC systems.
- The risks of electrocution may result from careless use of the AC system.

**!**

**NEVER:**

- work on a live electrical system;
- modify the electrical system of the vessel or the relevant diagrams: It is important that the installation, maintenance and any modifications be carried out by a technician qualified in marine electricity;
- change or modify the strength of the safety devices protecting against power surges;
- install or replace electrical equipment or materials with components which exceed the system's nominal electrical power capacity;
- leave the boat unsupervised when the electrical system is live, apart from when the automatic bilge pump and the boat's fire protection and security systems are in use (if the boat has one).

**!**

Electrical connections change in time. It is therefore necessary to have the electrical installation of the boat checked regularly and at least once every two years by a professional. Special attention should be paid to the tightening of the electrical connections.



## 7.2 DC INSTALLATION (12V OR 24V)

### 7.2.1 Battery use and distribution

#### General points

The boat is equipped with a direct current electrical system.

The boat's electrical system comprises service batteries and the engine battery or batteries. The service batteries serve as the power supply for all the boat's electrical components. The "engine" battery is used only for powering the electric starter of the propulsion engine.

The boat may also be equipped with:

- a generator powered by its own battery;
- a bow thruster, powered by its own battery bank.

the batteries are charged either by a load distributor or:

- by the alternator linked to the engine when the engine is running,
- by the battery charger (if the boat has one).

It is imperative that when the boat is first launched, a professional engineer connects the batteries.

Always check the condition of the batteries and charge system before putting to sea.

The battery banks are isolated from one another by a charge divider (see below).

#### Battery set

Generator battery: 110A

Engine battery: 2 x 110A



Service batteries: 115A



Spare service batteries: 115A



Propeller battery: 2 x 50A



Voltmeter  
Location: Passageway



#### Maintenance

- Avoid charging batteries to a voltage greater than 14,6 V.
- Keep the batteries clean and dry.
- Regularly check that the terminals and connection cables are clean. If necessary, apply a thin coating of paraffin on the terminals, to prevent corrosion.
- Regularly recharge all of the batteries onboard.
- Continuously maintain the charged batteries: this determines their length of life.
- Avoid long periods of electrical inactivity (for example when wintering the boat).

#### Maintenance of lead batteries

- Every year check the water levels in the batteries, and if they are low top them up with distilled water.
- Keep all metallic objects away from the batteries.
- Lead batteries contain sulphuric acid: Be careful not to knock them over whenever handling them.



- All work carried out on a battery must only be carried out by someone qualified to do so. Whenever working on a battery, wear safety goggles and protective clothing.
  - Never smoke or produce a spark near a battery: risk of an explosion.
  - If any acid accidentally splashes on your skin or in your eyes thoroughly rinse it off immediately with fresh water. See a doctor immediately.
  - Never touch the battery terminals: danger of electric shock.
  - Refer to the manufacturer's instructions for use and maintenance.
- **IT IS IMPERATIVE TO DISCONNECT THE BATTERY CHARGER BEFORE DISCONNECTING THE BATTERY TERMINALS FOR MAINTENANCE.**

### Maintenance of watertight batteries

- This type of battery needs no maintenance and does not produce any gas during normal use. No ventilation is needed.
- The optimum temperature for use is between 10 degree C and 30 degrees C. Lower temperatures will reduce the available capacity. Higher temperatures will increase the batteries' self-discharge rate.
- Never open watertight batteries.
- Never add acid or distilled water.
- The pressure valves are used to seal the batteries and cannot be opened without being destroyed.
- If the batteries overheat, a build-up of gas may develop: Keep away from the batteries.

### 7.2.2 Battery switch

- Manual battery switches: to make the system live, manually turn the positive and negative battery isolator switches.

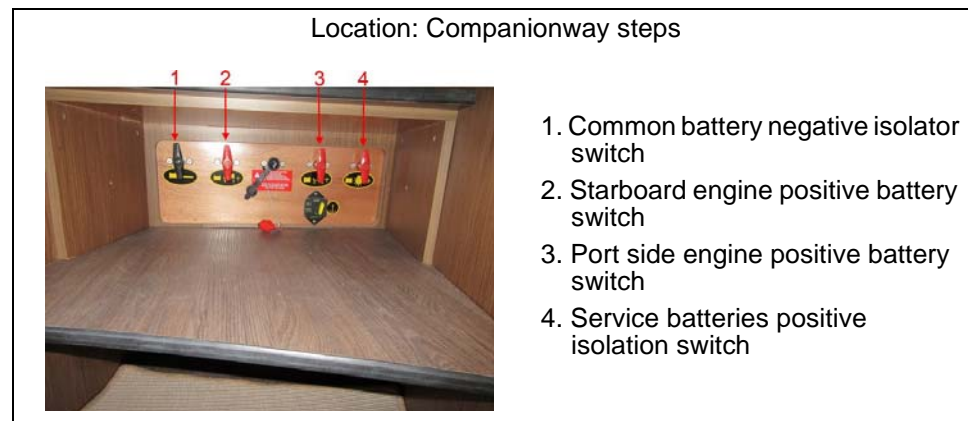

- Electrically controlled battery breakers: In the event of electrical failure, it is possible to press down the button on top of the battery breaker manually to activate it. The electrically-controlled battery breakers use very little electricity when they are on: **It is imperative to turn off all the battery breakers during lengthy absences, to prevent the batteries from slowly and irreversibly discharging.** The engine's positive battery isolator automatically comes on and goes off when the engine is started/stopped. The negative of the circuit is connected to the general negative.



### 7.2.3 Power distributor

- The electronic charge dividers isolate the battery banks from each other and allow the charge to be directed automatically to the battery with the lowest charge. They give the advantage of preventing a drop in voltage.
- The charge divider is electronic. It is designed to distribute the charging current with a low voltage drop between the battery banks (engine and service batteries). It prevents the current from circulating from one battery to another. When the voltage of the charger or alternator is available, the charge divider's green indicator comes on.

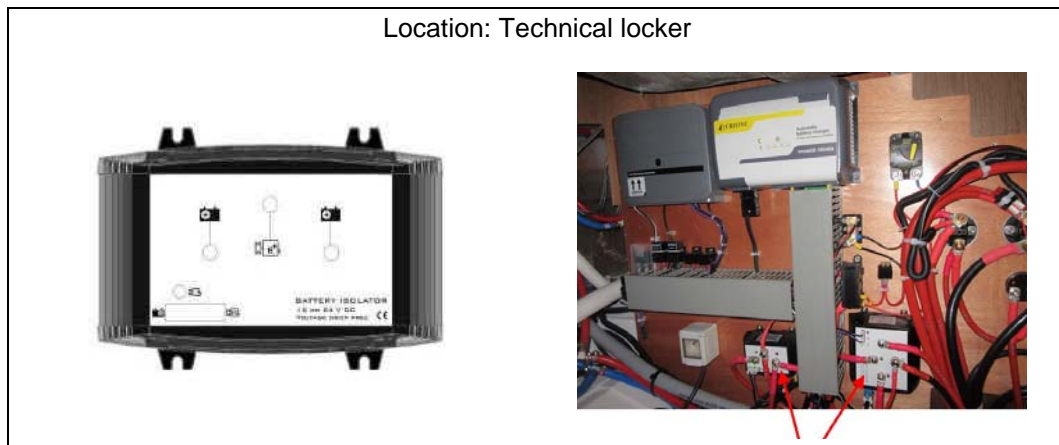

### 7.2.4 Connection of battery set

If one of the engine batteries is low on power, use the battery link function by actuating the linking system.

#### Coupling handle

Put the handle in the place provided for it. Turn the handle to connect the coupling circuit when starting the engine. Remove the handle once the engine is running.



## 7.2.5 Battery charger

### General points

- The battery charger runs on AC power.
- A breaker protects the electrical circuit.
- The battery charger charges all of the batteries onboard, while keeping the service battery bank isolated from the engine's battery bank.
- Within its power limits, the DC equipment can be supplied directly.

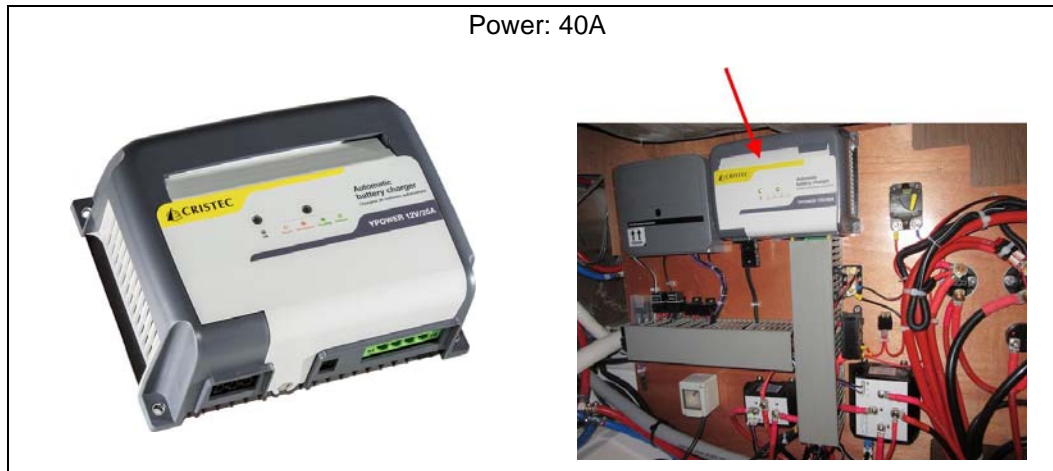

### Operation

- The charger runs fully automatically. It can remain permanently connected to the batteries and does not need to be disconnected when starting the engine.
- In some electrical circuits, there may be battery chargers coupled in parallel.

### Maintenance

- Before doing any maintenance, cut the AC supply.
- Regularly vacuum out any dust particles which may accumulate in the charger. An annual check of the tightness of the nuts and bolts is necessary to ensure the correct operation of the charger.

**! IT IS IMPERATIVE TO DISCONNECT THE BATTERY CHARGER BEFORE DISCONNECTING THE BATTERY TERMINALS FOR MAINTENANCE.**

# LAYOUT DIAGRAM - BATTERY CABLES

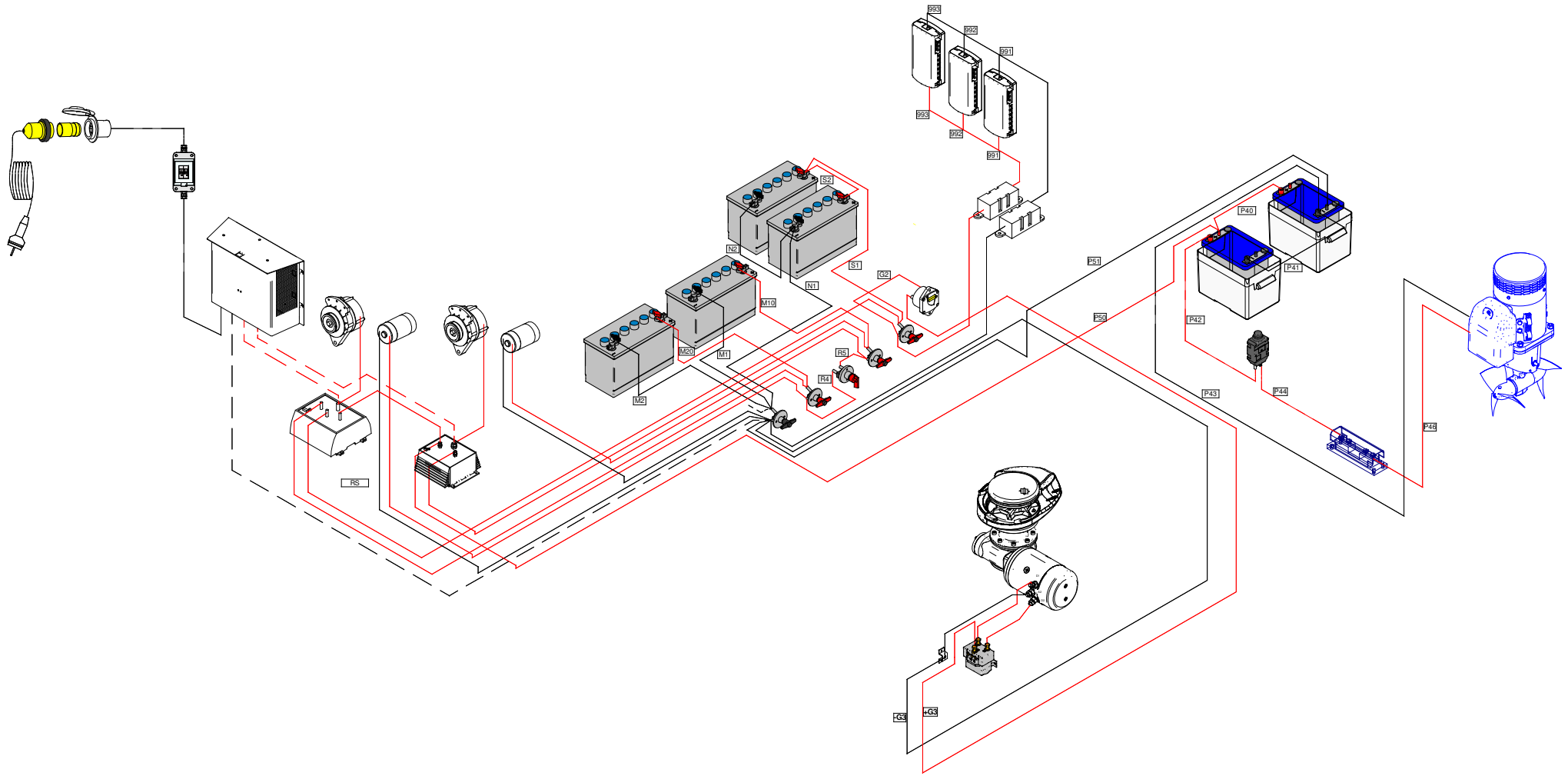



## 7.2.6 Layout of the wiring looms in the hull - DC circuit

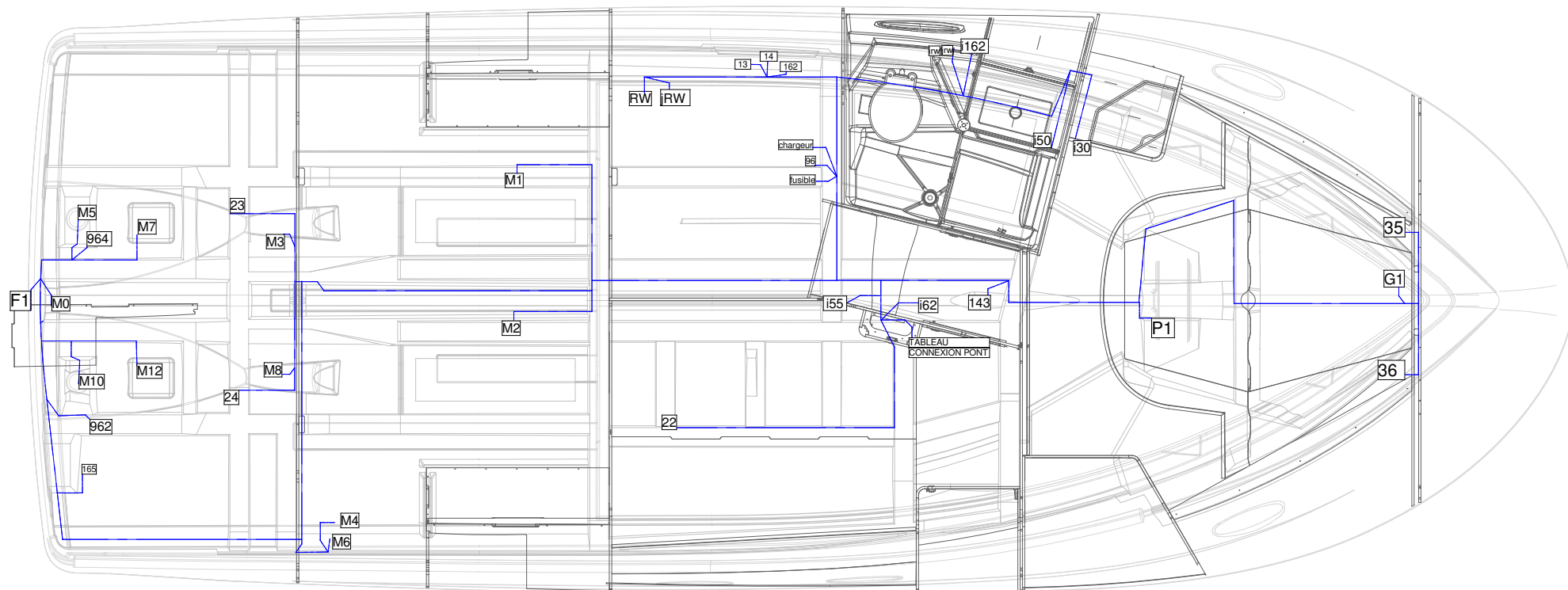



7.2.7 Layout of the deck wiring looms - DC circuit

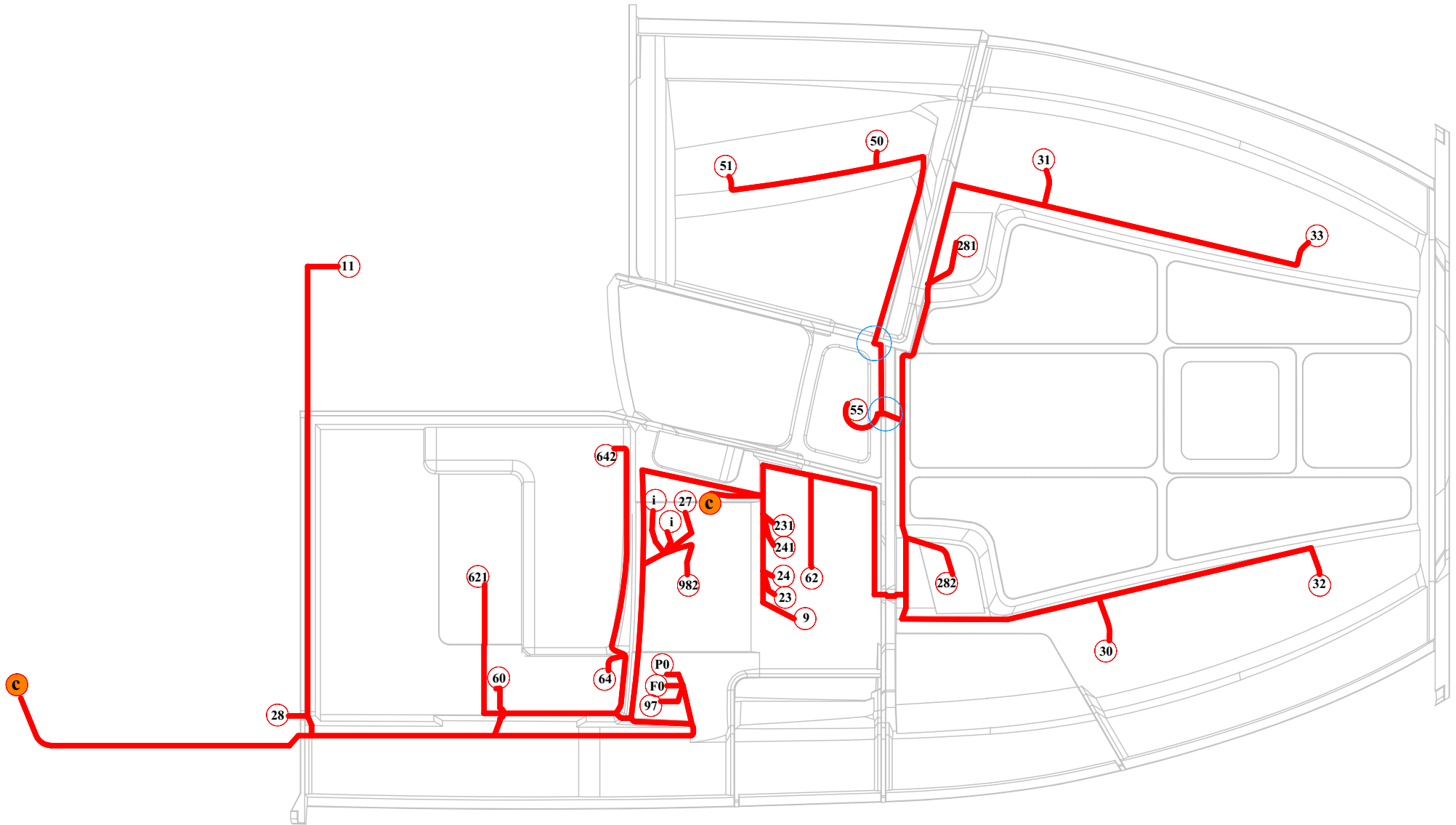

### 7.2.8 Layout of the wiring looms in the deck counter-moulding - DC circuit

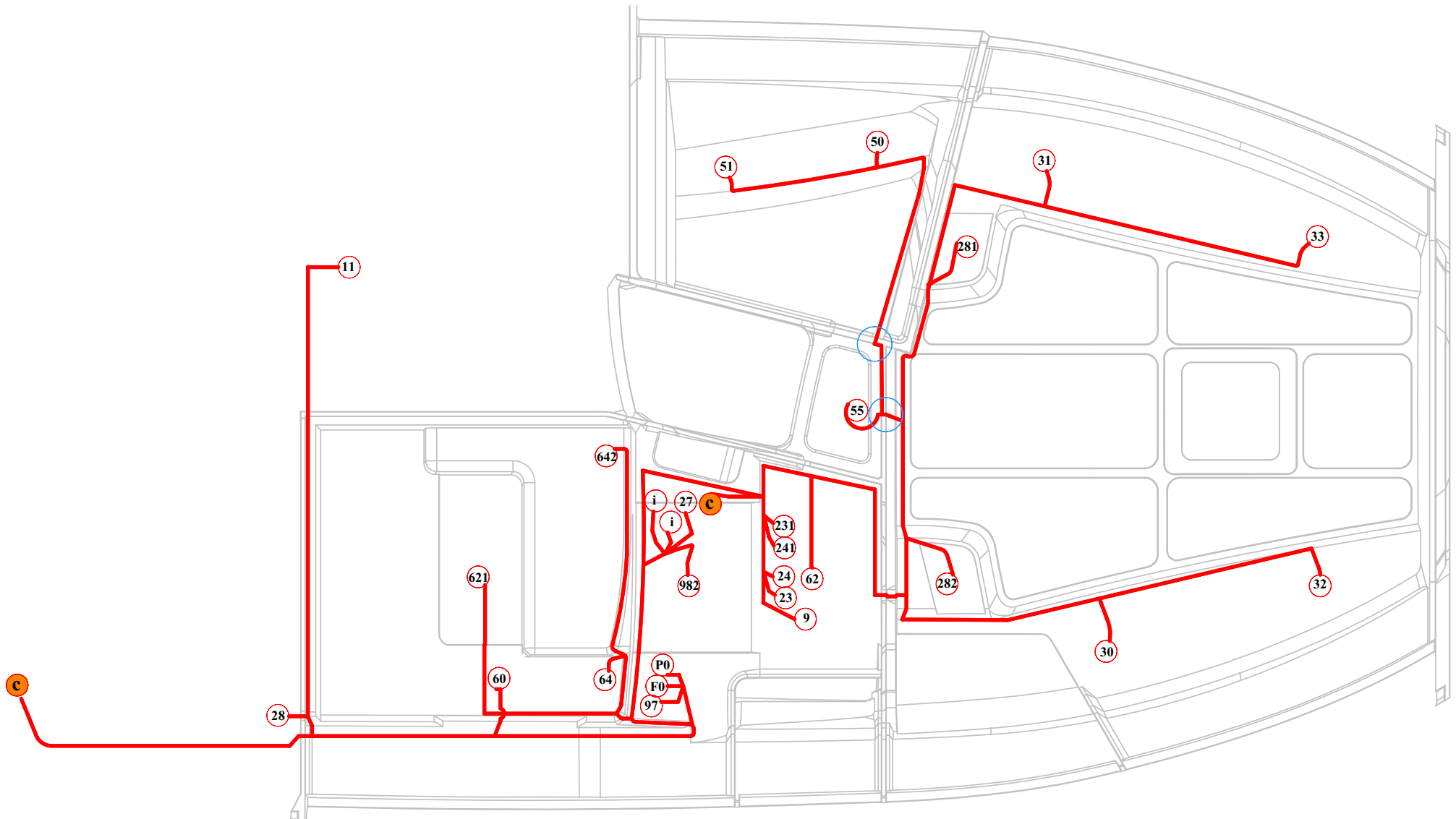

7.2.9 Flybridge backing mould wiring loom plan - DC circuit

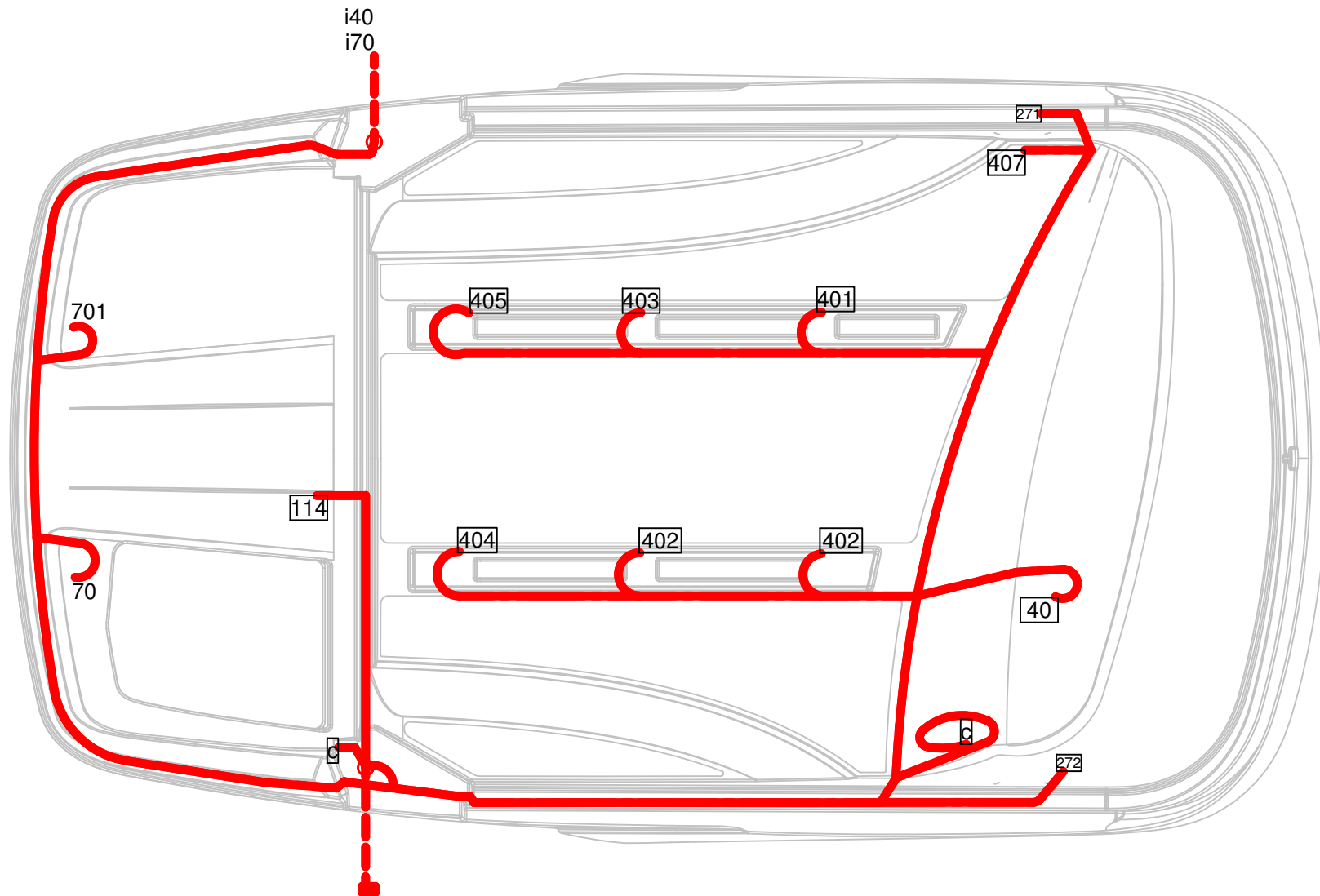

## 7.2.10 Steering station switches



Location: Saloon

from left to right - Downward:

Electronic

Horn

Windscreen washer

Port windscreen wiper

Starboard windscreen wiper

Navigation lights / Mooring light

Water unit

Electric bilge pump - Technical locker

Electric bilge pump - Passageway

Electric windlass

### 7.2.11 Fuses

- A fuse protects an electrical circuit from a power surge. If it blows, you must replace it with another fuse of the same rating.

General fuse 12V - 100A



Location: Aft cabin

Please refer to the key on the following page



 When replacing fuses/circuit-breakers, always ensure replacements are of the right capacity (see the colour-codes)

20A	15A	10A	5A	3A
-----	-----	-----	----	----

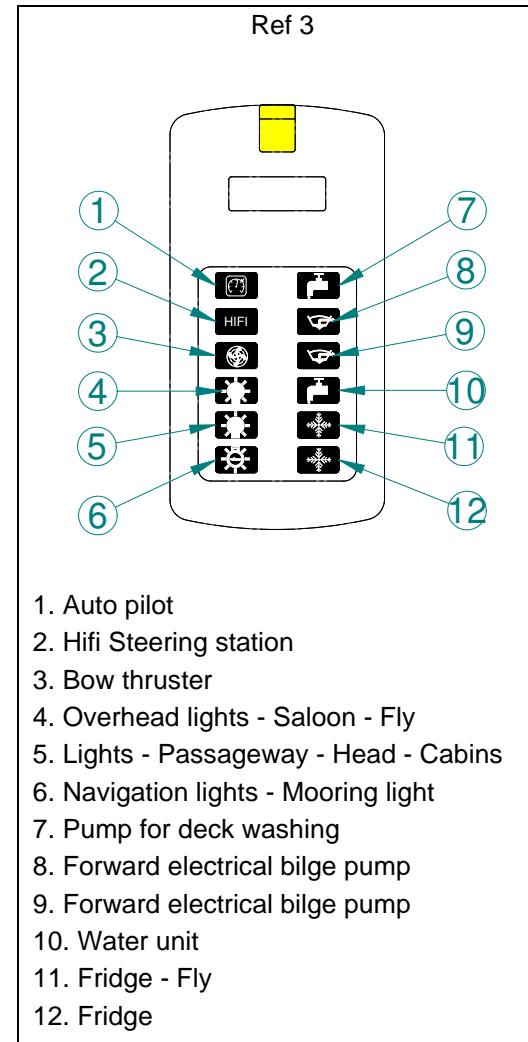
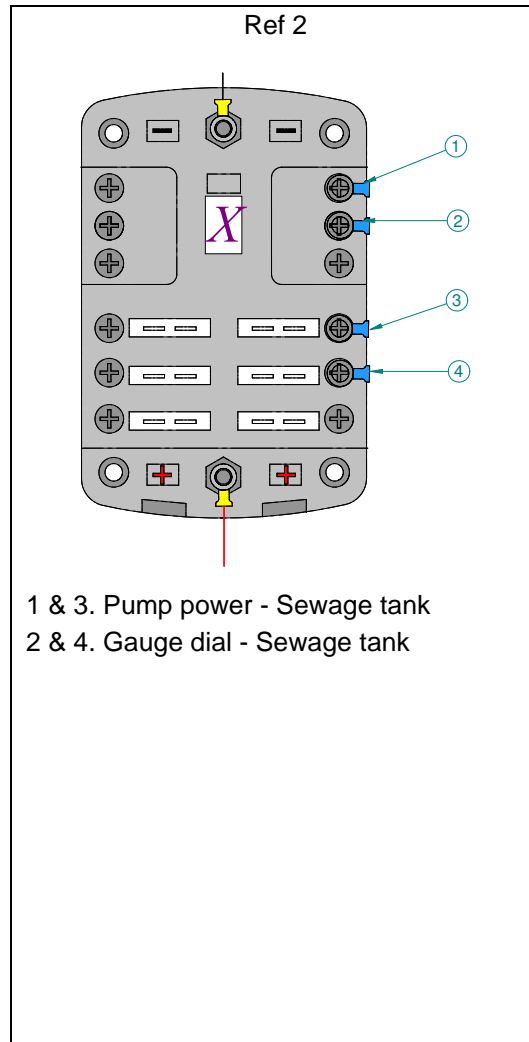
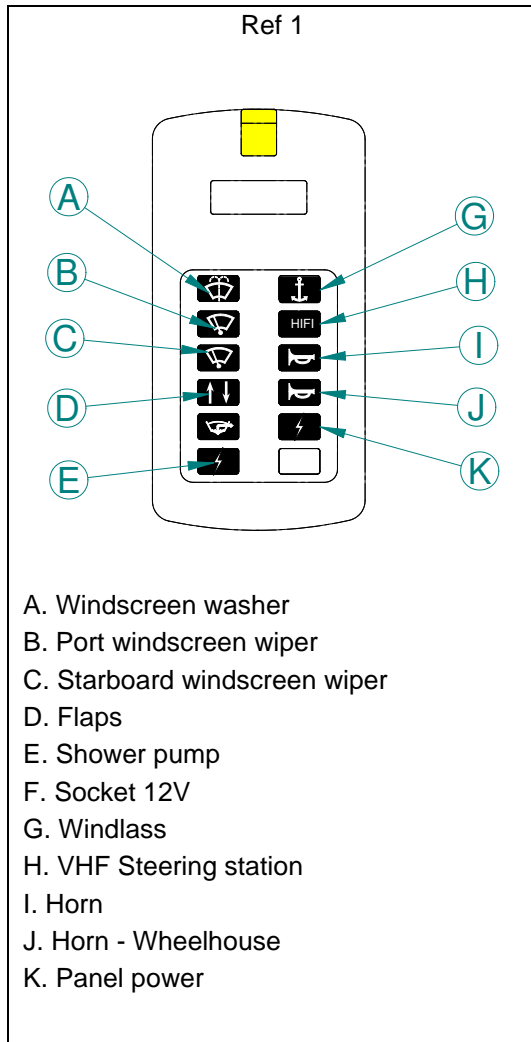

## 7.3 AC SYSTEM (110V OR 220V)

### 7.3.1 General points

- The boat is equipped with an alternating current electrical system.
- The electrical system of the boat consists of an AC shore socket and if appropriate:
  - 1 Generator.
- The AC electrical system is used to power the following components (if the boat has one):
  - Air conditioning,
  - Household appliances,
  - Water heater,
  - Interior AC sockets,
  - Battery charger(s).

#### Recommendations for using the AC electrical system correctly

- Do not modify the vessel's electrical installation nor its relating diagrams. The installation, maintenance and any modifications must be carried out by an electrician qualified in marine electricity. Have all electrical installations checked (tightening and connections) every year.
- Disconnect the boat's shore power when the system is not in use.
- Connect the relay cans or metal casing of the electrical equipment installed to the boat's protective conductor (green or green with yellow stripe conductor).
- Use double insulated or earthed appliances.
- If the reverse polarity indicator is activated, do not use the electrical installation. Rectify the polarity fault before using the vessel's electrical installation (this applies only to polarised circuits with a polarity indicator).



- Never let the end of the boat/shore supply cable hang in the water: The result may be an electric field liable to hurt or kill the swimmers nearby.
- There may be danger of electrocution if alternating current systems are incorrectly used.
- Do not work on a live AC system.



Electrical connections change in time. It is therefore necessary to have the electrical installation of the boat checked regularly and at least once every two years by a professional. Special attention should be paid to the tightening of the electrical connections.



To reduce the risks of electric shock and of fire:

- Turn off the shore supply with the onboard cut-off switch before connecting or disconnecting the vessel/shore supply line.
  - Connect the ship/shore power cable on the boat before plugging it into the socket onshore.
  - Disconnect the ship/shore power cable at the shore socket first.
  - If the reverse polarity indicator is activated immediately disconnect the cable.
  - After using the socket onshore, close its protective cover tightly.
  - Do not modify the connections of the ship/shore power cable: only use compatible connections.
- DO NOT MODIFY THE CONNECTIONS ON THE SHIP/ SHORE POWER CABLE.**



Every month, you are advised to test the circuit breaker or residual current differential switch that can be recognised by its "test" button.

### 7.3.2 AC shore socket

#### location of components

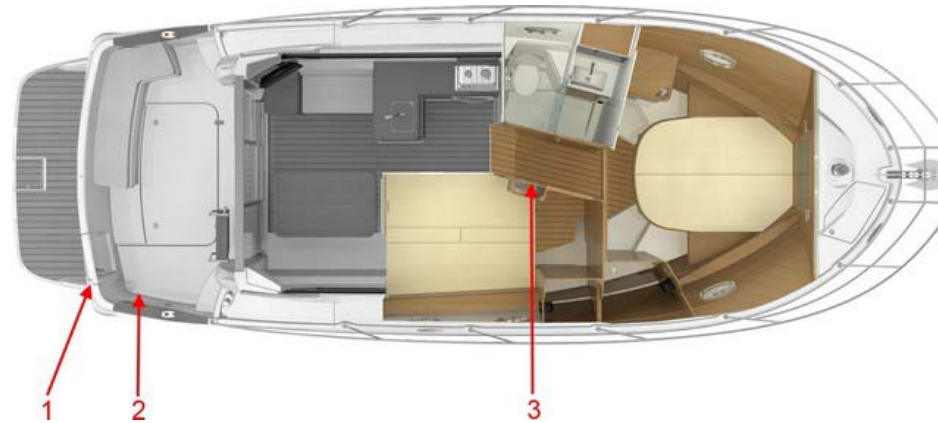

Ref 1: AC shore socket



Ref 2: Breaker (Protection)



Ref 3: Breaker (Operation)



#### Operation

- First plug the extension cable into the AC socket on the boat, then into the socket onshore.
- First unplug the extension cable from the socket onshore, then from the AC socket on the boat.



### 7.3.3 Layout diagram

#### AC ELECTRICAL SYSTEM

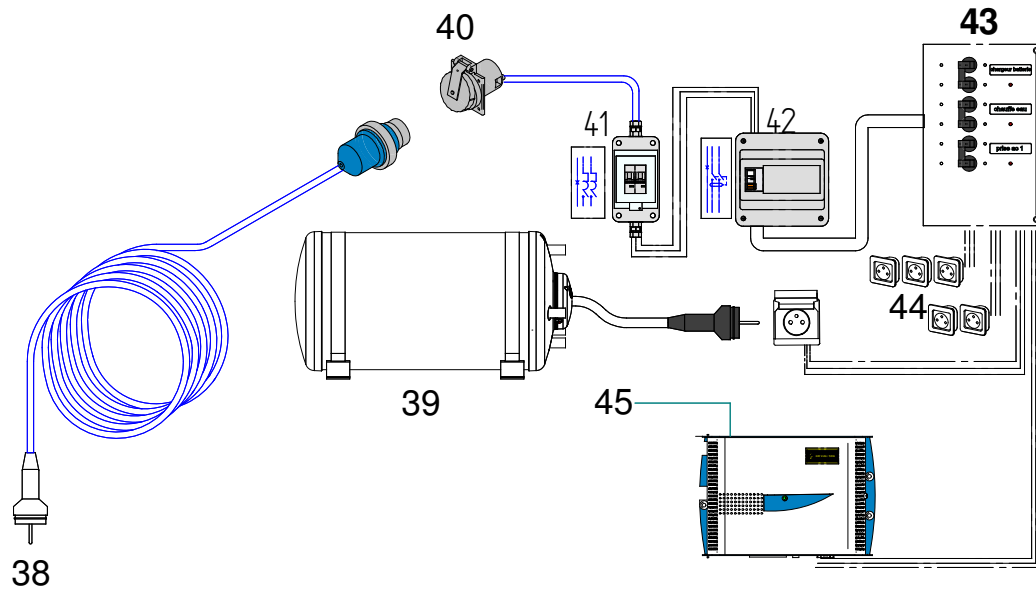

Reference	Designation
38	Socket (16A)
39	Water heater (220 V)
40	Shore power socket (30A)
41	Breaker (32A)
42	Differential (40A)
43	Electrical panel (220 V)
44	220V Sockets
45	Battery charger (40A)

### 7.3.4 Installation of hull wiring harnesses - AC circuit

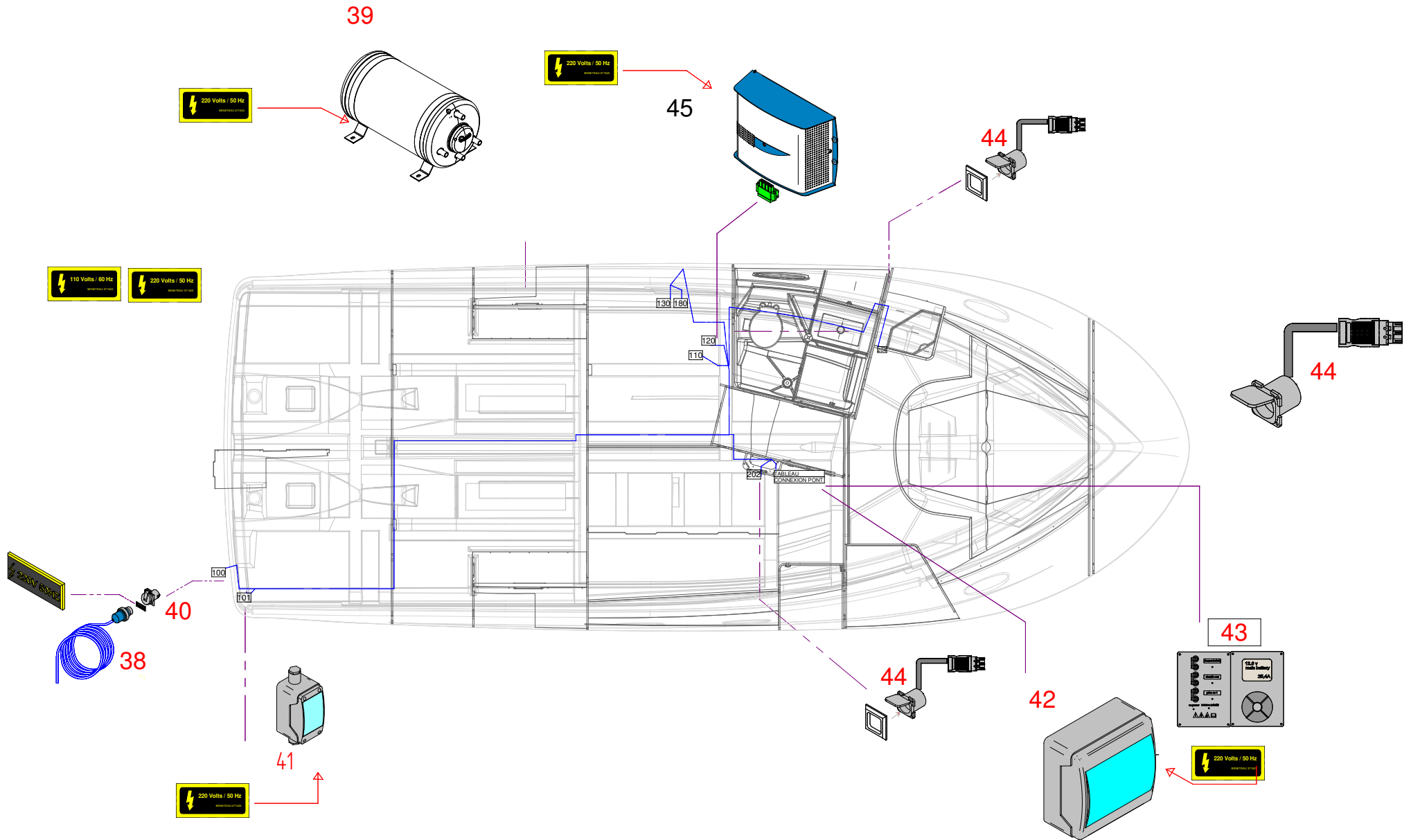

Reference	Designation
38	Socket (16A)
39	Water heater (220 V)
40	Shore power socket (30A)
41	Breaker (32A)
42	Differential (40A)
43	Electrical panel (220 V)
44	220V Sockets
45	Battery charger (40A)

## 7.4 PROTECTION AGAINST ELECTROLYSIS / EARTH PLATE

### 7.4.1 Anodes

#### General points

- The sacrificial anodes protect the boat's metal components from electrolysis.
- A sacrificial anode is a consumable part that protects submerged metal parts by its dissolution (oxidation). The anodes used are made of a metal that is more readily reductive than the metal they are protecting.
- On a new boat, all the underwater metallic components try to be at the same electric potential, which leads to the rapid deterioration of the anodes in the first few weeks in the water.
- You can put several anodes on the hull.

#### Maintenance

- At least 2 times a year, check the corrosion on all of the anodes. Change the anode if necessary (Before it lost 50% of its weight).
- Use the appropriate anodes for the cruising area: fresh water/magnesium anodes; Sea water/zinc anodes.
- If the motor mountings are raised, the anodes are out of the water: in this case the anodes can no longer protect the sterndrive: take note of the skipper's recommendations.
- When the boat is kept in a dry dock, a light deposit of dust will settle on the anodes: Before returning the boat into the water, clean the anodes.



- Never cover the anodes in antifoul.
- During the first few weeks that the boat is in the water, check the anodes and if necessary replace them: they erode very rapidly during this period.

### Cleaning anodes

- Use sandpaper. Do not use metal brushes or steel tools to clean the boat, it may damage the galvanic protection.

### Replacing the anodes

- The anodes are fastened with screws and nuts. First, remove the screws and nuts that hold the anode, then clean the contact surface. Press the new anode to obtain a good electrical contact.

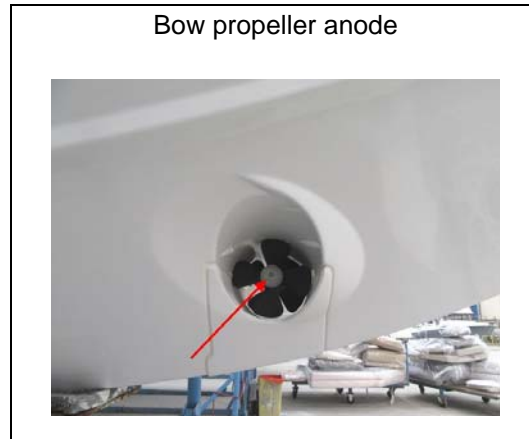
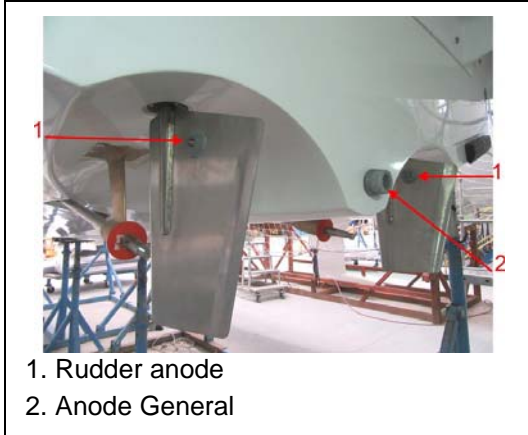

### 7.4.2 Earthing plates

- An earthing plate is a shot-peened plate mounted on the hull to recreate an earth neutral point on the electrical circuit of the equipment supplying AC power (generator and AC/DC convertor). The earthing plate earths this equipment.

**The earthing plate is not an anode: it must not be allowed to deteriorate.**

- If it deteriorates, consult a professional immediately to determine the cause. As the earthing plate is mounted across the hull below the waterline, if the earthing plate deteriorates the boat is at risk of sinking.



Never antifoul over the earthing plates.

## LIQUEFIED PETROLEUM GAS SYSTEM (LPG)

■ General points .....	76
■ Operation of the LPG system .....	78
■ Verification of the LPG system .....	78
■ Layout diagram.....	81

## 8.1 GENERAL POINTS

- The working pressure of the LPG unit is 28 millibars.
- Recommended cylinder capacity:
  - Europe Version: 2,75 kg of butane.
  - US Version: 5 lb of propane.
- Have the hoses, the entire LPG system and the flue pipes in the LPG system inspected professionally and regularly (or at intervals determined by the national requirements of the country in which the boat sails), and have them replaced if damage is detected.
- Taps attached to empty cylinders must be closed and disconnected. Protective covers, lids or caps must be held in place. Spare bottles must be stored outside on the boat, protected from weather and mechanical damage. Any gas leaks must be only towards the outside of the boat.
- Do not impede access to the components of the LPG system.
- Do not use the housings or the LPG bottle lockers to store other equipment.
- Check the vent pipes at least once a year. Replace them if they have deteriorated or split.



**location of components**

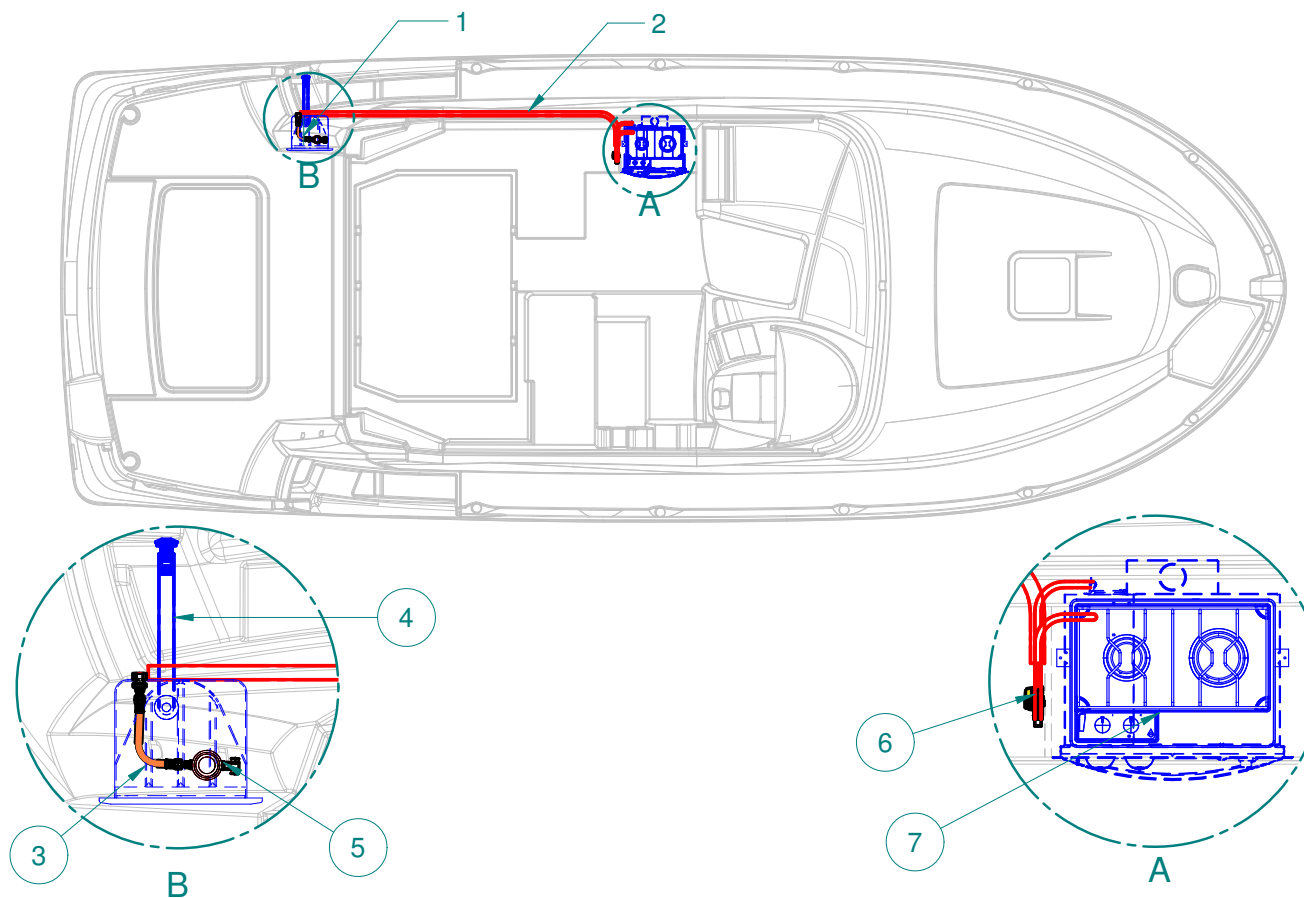

Reference	Designation
1	Gas bottle locker
2	Gas supply
3	Gas bottle connection kit
4	Gas locker drain
5	Regulator valve
6	Gas supply valve
7	Hob / Oven

## 8.2 OPERATION OF THE LPG SYSTEM

- Valves for supply lines and cylinder valves must be closed when appliances are not in use, before changing a cylinder and immediately in case of emergency.
- Appliance valves must be closed before opening the cylinder valve.
- It is necessary to ventilate when appliances that consume oxygen from inside the boat are used.
- If the stove is not suspended by gimbals, it should not be used when wide roll angles or continuous listing are likely.
- Please refer to the manufacturer's notes for the use and maintenance of the LPG cooker.

## 8.3 VERIFICATION OF THE LPG SYSTEM

The LP system should be tested for leakage before each use in any of the following ways:

- If the LPG circuit is equipped with a pressure gauge:

Before each use, close the appliance valve, open the LPG cylinder valve, allow the pressure gauge to stabilize, close the LPG cylinder valve, observe the pressure indicated by the pressure gauge near the LPG cylinder for 3 minutes. The pressure indicated by the manometer should be constant if there is no leak in the system.

The pressure indicated by the manometer should be constant if there is no leak in the system. If bubbles are observed in the detector liquid, there is a leak.

**NOTE: the pressure gauge gives no indication of the amount of LPG remaining in the cylinder, but only its vapour pressure, which is a constant at a given temperature.**

- If the LPG circuit is equipped with a bubble leak detector, use it as follows:

Regularly observe the bubble leak detector.

OR

Once the installation is under pressure and stabilised, press the detector push button. The installation is not leaking if bubbles do not appear in the detector liquid. If bubbles are observed in the detector liquid, there is a leak.

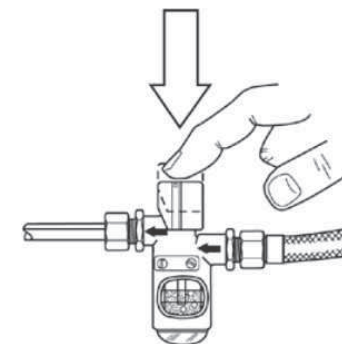

- Carry out a manual search by applying a foaming solution, or soapy water or a detergent (with the taps of the burners closed and those of the installation and of the gas bottle staying open). The foaming solutions for detecting leaks in the gas installations conforming to the EN 14291 meet these requirements.

- If an LPG leak is detected or suspected, immediately take the following measures:
  - Do not use LPG appliances;
  - Disconnect the LPG supply from the supply valve(s);
  - Extinguish all naked flames and other sources of ignition (heaters, cooking appliances, pilot lights, etc...);
  - Do not operate electrical switches;
  - Evacuate the area if possible.

**NOTE: The leak tests carried out by the boat user do not replace a regular and complete checking of the LPG circuit by a competent professional.**

#### To change an LPG bottle

1. Close the tap on the LPG bottle
2. Detach the LPG bottle
3. Replace the LPG bottle
4. Attach the new LPG bottle
5. Open the tap on the LPG bottle



- When the cooker is on, ventilate well to prevent any risk of asphyxiation.
- Do not use the cooker as a means of heating.



- If a leak or fire from an LPG tank is detected, close the main LPG supply valve and do not use LPG appliances.
  - Do not use an installation with a leak before it has been inspected and repaired by a competent person.
  - Do not modify the boat's LPG system. The installation, modification and maintenance should be carried out by a competent person. Have the system checked at regular intervals or as fixed by national requirements.
  - Never use a naked flame to check for leaks.
  - Do not use a hotplate or an oven to heat the living areas.
  - Equipment with a naked flame burning fuel consumes the oxygen in the cabin and gives out combustion residue in the boat. Ventilation is necessary when this equipment is used. Open the vents provided for this when using this equipment. Do not use a hotplate or an oven to heat the living areas. Never obstruct the vents provided for ventilation.
    - Ventilation requirements have been calculated for LPG appliances as installed. Additional ventilation openings may be required if other appliances are installed simultaneously (please consult a professional).
    - Never leave the boat unsupervised when equipment using LPG with a naked flame is on.
  - Do not smoke or use a naked flame when replacing LPG bottles. Close the tap on the empty bottle before detaching it to replace it.
  - To ensure sufficient ventilation, make sure that you open the hatches or ports near the hotplate when using it.



- Do not use solutions containing ammonium when testing for leaks manually (ammonia, which is present in certain soaps and detergents, attacks brass connections). Although the damage may at first be impossible to detect, the cracks and leaks may appear several months after the contact with the ammonia).

## LAYOUT OF COMPONENTS

Gas cylinder locker



Hob / Oven



Gas supply valve



System Piezzo



## 8.4 LAYOUT DIAGRAM

Europe Version

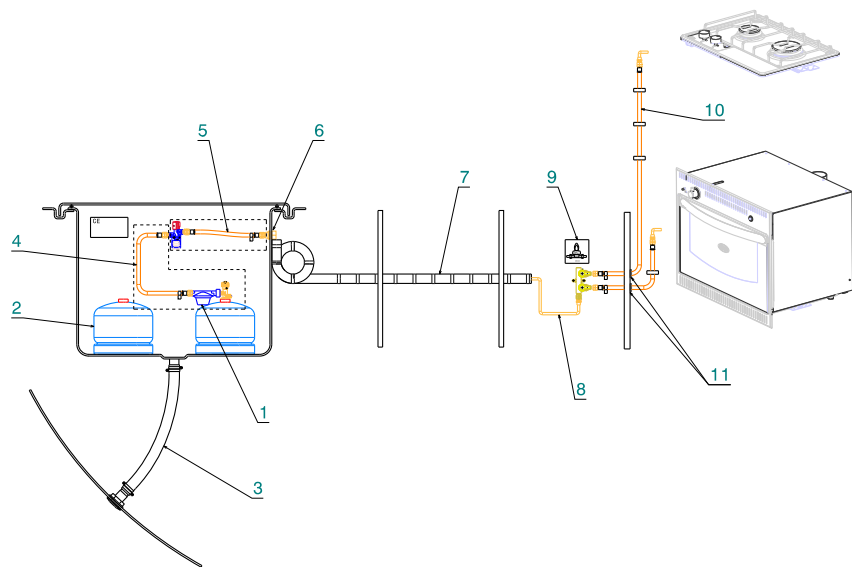

Reference	Designation
1	Regulator valve
2	Gas cylinder
3	Drain
4	Gas bottle connection kit
5	Bubble tester kit
6	Rubber washers
7	PVC girdled sleeve
8	Copper gas connection kit
9	Label
10	Gas appliance connection kit
11	Thru-wall fitting

US Version

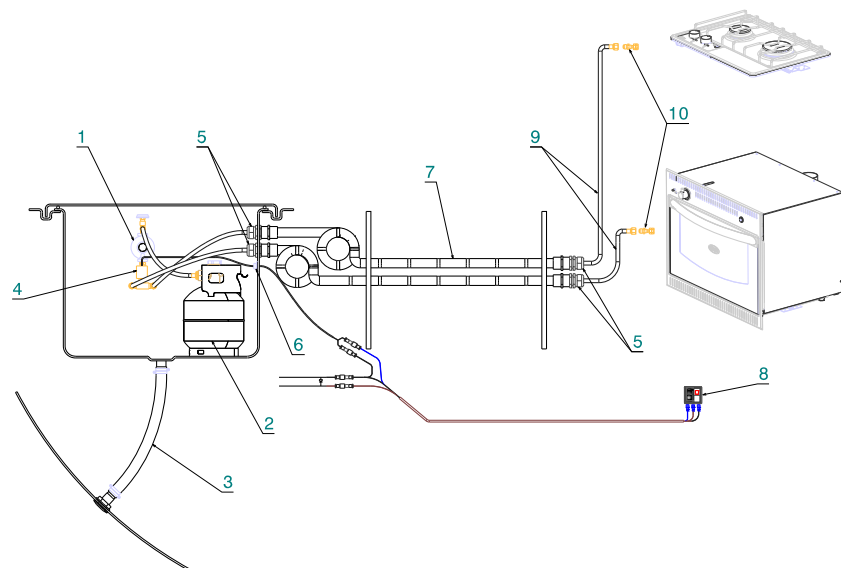

Reference	Designation
1	Regulator valve
2	Gas cylinder
3	Drain
4	Electromagnetic valve (12V)
5	Thru-wall fitting
6	Wire passage
7	PVC girdled sleeve
8	Solenoid switch
9	Plastic propane pipe
10	Gas appliance connection kit



## DOMESTIC APPLIANCES

■ Fridge / Cooler .....	84
■ Hot plate .....	86

## 9.1 FRIDGE / COOLER

### General points

- The fridge is composed of 3 components: the compressor, the evaporator and the condenser. These components are connected by a closed circuit refrigerant gas circuit. The fridge is air-cooled.
- The fridge is DC powered. It is designed to chill food and drink. Any other use is dangerous and forbidden.
- A breaker protects the electrical circuit.
- The icebox without an evaporator keeps the food and drink chilled.
- The ON/OFF start button is located on the fridge.
- The thermostat is in the inside compartment of the fridge. It enables the selection of the desired temperature setting for the inside of the fridge.
- The refrigeration power can be affected by:
  - The ambient temperature,
  - The quantity of food to chill,
  - The frequency of opening the door.

### Maintenance

- Clean the evaporator with a damp cloth at least once a year. Never use cleaners which are abrasive, acid or which contain solvents for cleaning the evaporator.
- Regularly clean the fridge/icebox door seal with a damp cloth.
- Regularly defrost the fridge.
- When winterising the boat, leave the fridge door/icebox cover open to prevent mould and smells from developing.



- Refer to the manufacturer's instructions for use and maintenance.
- Never heat or use tools to defrost the inside of the fridge more quickly (risk of damaging the interior surface).
- Never obstruct the heat exchanger of the fridge.



Fridge (Galley)



Control / Thermostat  
located in the unit



Fridge (Flying bridge)



Thermostat  
located in the unit



## 9.2 HOT PLATE

### General points

- The hob runs on an AC power supply.
- A breaker protects the electrical circuit.

### Starting up

- On the switch select the chosen source of current (shore power or generator).
- Turn the hob circuit breaker to ON.

## AUDIO-VISUAL EQUIPMENT

■ Television.....	88
■ Hifi.....	89

## 10.1 TELEVISION

### General points

- The television is powered by AC provided by the DC/AC inverter which is powered by the service batteries. The inverter has an ON / OFF button.
- A circuit-breaker protects the circuit.
- Pre-cabling for the aerial is already installed on the boat.

### Starting up

- First turn on the circuit breaker, then switch on the TV.
- The transformer is switched on and off automatically when you turn on or off the breaker.

Location: Saloon



Inverter  
Location: Aft cabin



## 10.2 HIFI

- The sound system is DC powered.
- The sound from the TV or from the DVD player is amplified by the boom box and the speakers.
- The sound from the TV comes out of the integral speakers.
- The sound from the TV can come from the speakers if AUX is selected on the DVD player.
- The sound from the DVD player comes from the speakers.
- The sound from the radio comes from the inside and outside speakers. It is possible to select either outside or inside speakers by adjusting the balance control.



Refer to the manufacturer's instructions for use and maintenance.



## ONBOARD COMFORT

■ Air conditioning .....	92
■ Electronic equipment .....	97
■ Equipment other than for propulsion, which burns fuel (Generator, Heating) .....	99

## 11.1 AIR CONDITIONING

### General points

- The air-conditioning is powered by alternating current.
- The air-conditioning cools the air temperature inside the boat (only when the boat is floating in water).
- The cooling circuit consists of one or more compressors that operate independently. A compressor is called "reversible" because it can heat the boat if the sea water temperature exceeds 13°C.
- In winter, you can programme the dehumidifier function on the airconditioning controls.
- The refrigeration compressors are made by one or two seawater pumps. These pumps are run on AC voltage and are master controlled by one or two can relays.
- Sea water is evacuated through a through-hull fitting equipped with a valve, located above the waterline. Each compressor has its own through-hull evacuation fitting. It is advisable to check the flow of water visually once the air conditioning starts running.

### Operation

Before starting the engine:

- Open the raw water intake valves and evacuation valves;
- Make sure that the control panel is in the STOP position;
- Use the switch on the chart table to select the power source (shore power or generator).
  - If using shore power: plug into the shore power socket;
  - If using the generator: before turning on the air conditioning, leave the generator running for about 3 minutes.

If the seawater pump is deprived (eg. in case of running aground), follow the following procedure:

- Disconnect the discharge hose from the seawater pump by loosening the 2 stainless steel collars;
- Blow air through the pipe using a compressor;
- Re-connect the discharge hose with 2 stainless steel collars.

The air conditioning is running:

- Switch the air-conditioning circuit-breakers ON.
- Select the temperature of each compressor using the control units.



## DIAGRAMMATIC VIEW - AIR CONDITIONING

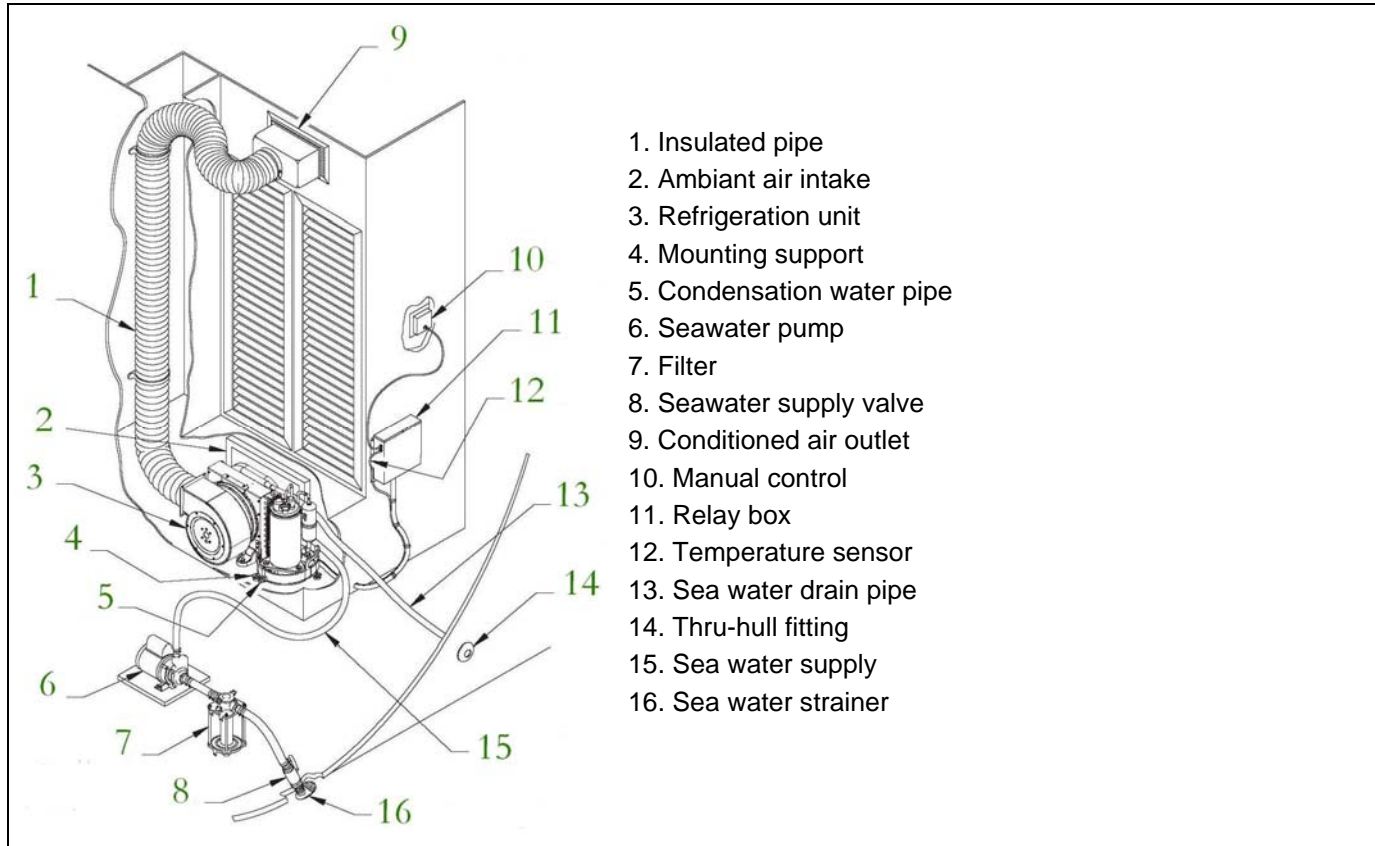

- !**
- Refer to the manufacturer's instructions for use and maintenance.
  - When the air-conditioning is running, check visually that the sea water has been fully drained.
  - Never start the generator when the climate function is already on.
  - Always turn off the air conditioning before turning off the generator.
  - Regularly check and clean the sea water filter placed on the sea water intake through-hull fitting:
    - Close the sea water intake valve;
    - Unscrew the top of the filter;
    - Clean the strainer;
    - Put everything back in place.
  - Clean the air filter (located in the compressor) regularly for maximum performance of the installation.
  - Clean the cooling coil at least once a year.
  - To prevent the air-conditioning circuit from freezing: never run the system when the seawater temperature drops below 5 degrees C.
    - Winter Storage: drain the whole sea water system.
    - The cooling gas circuit needs no maintenance.

Air-conditioning controls

Please refer to the key on the following page

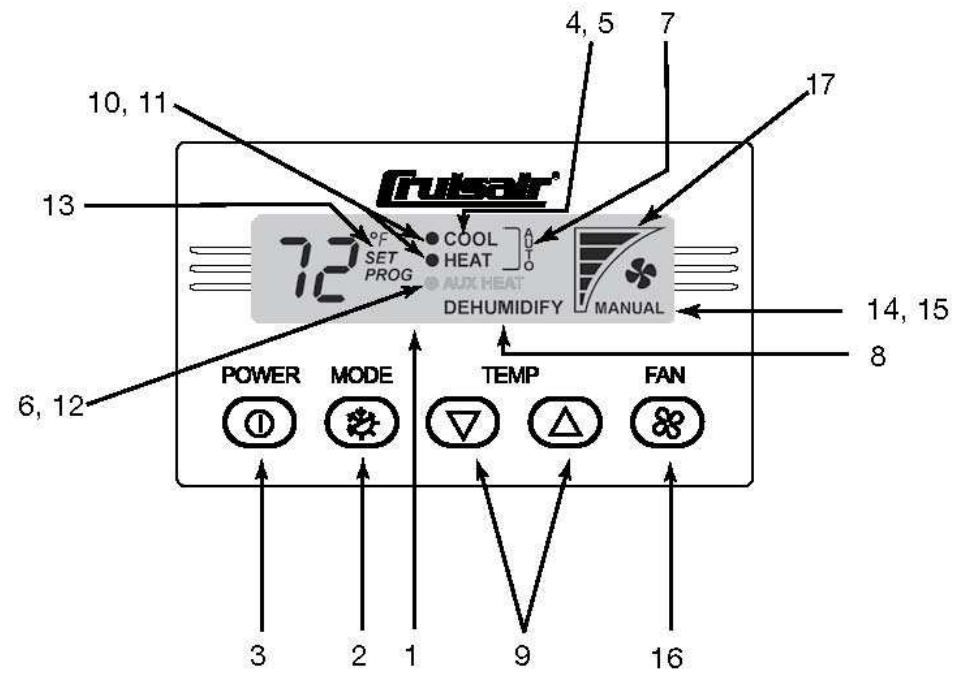

## Manual control of the air-conditioning

### 1. Data display

Screen which displays the desired temperature, the programmed values and the error messages.

### 2. MODE

Enables you to navigate between the different operating modes.

### 3. POWER/OFF

Comes on when the system is switched off. The manual ventilator may continue to run.

### 4. COOL

Indicates that the compressor is activated when cooling.

### 5. HEAT

Indicates that the compressor is activated when heating.

### 6. Option (Auxiliary heating).

### 7. AUTOMATIC

Comes on when the system is in AUTO mode.

### 8. DEHUMIDIFY

Comes on when the system is in dehumidifying mode.

### 9. Keys + and -

Allow you to raise or lower the desired temperature.

### 10. Cooling indicator

This indicates that the compressor is in COOLING mode.

### 11. Heating indicator

This indicates that the compressor is in HEATING mode.

### 12. Option (Auxiliary heating).

### 13. temperature control indicator

This indicates the temperature control adjustment (the desired ambient temperature).

### 14. Indicator for the manual ventilator

This comes on when the manual ventilator is running.

### 15. Indicator for the automatic ventilator

This comes on when the ventilator is running in automatic mode.

### 16. Ventilator key

Allows you to select manual or automatic mode for the ventilator.

### 17. Ventilator speed indicator

Shows the ventilator speed.

## NOTES

- When the system is programmed in dehumidifying mode, the system's safety devices remain active: if there is an interruption in the flow of sea water or a drop in AC voltage, the system automatically stops.
- In cooling mode, the system works efficiently when the sea water temperature is below 30 degree C.
- In heating mode, the system works efficiently when the sea water temperature is above 13 degree C.
- It is important to switch the system to HEATING mode at least once a month, to prevent the crossover cock becoming stuck in COOLING mode.

## **LOCKING METHOD**

- It is possible to lock the control buttons to avoid any accidental handling: Press the three buttons at once: MODE, UP (arrow pointing up), FAN. LC appears on the screen, which signifies "LOCK".

- To unlock and resume use of the buttons, press the three buttons at the same time: MODE, UP (arrow pointing up), FAN. UL appears on the screen, which signifies "UNLOCK".

## **SCREEN LIGHTING**

- If the control box is switched off by a fault (in the cabins for example), just touching a button automatically lights up the screen in a blue colour instantly.

To alter the light intensity of the screen, press the two buttons simultaneously: MODE, UP (arrow pointing up) until the required intensity is reached.

- It is possible to programme whether or not a box is illuminated by default: In this case mode ON must be selected for a permanently illuminated box or mode SLEEP for a permanently unilluminated box.

Procedure:

- Simultaneously press the 2 buttons: MODE and DOWN (arrow pointing down).
- With the arrows select n°18 on the menu, then confirm by pressing MODE.
- With the arrows select either ON for illumination by default or SL (SLEEP) to turn the box off.
- The press 2 times on FAN to confirm the selection.

## 11.2 ELECTRONIC EQUIPMENT

The onboard electronics are powered by direct current.

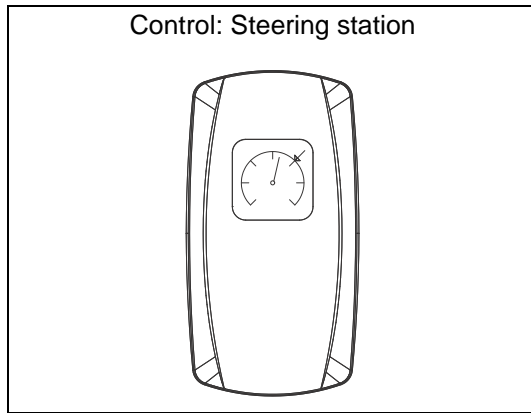

### LEAD LINES

- Do not store material on top of the sensors.
- Do not cover the sensors in antifouling when antifouling the hull.
- Regularly clean the sensors.

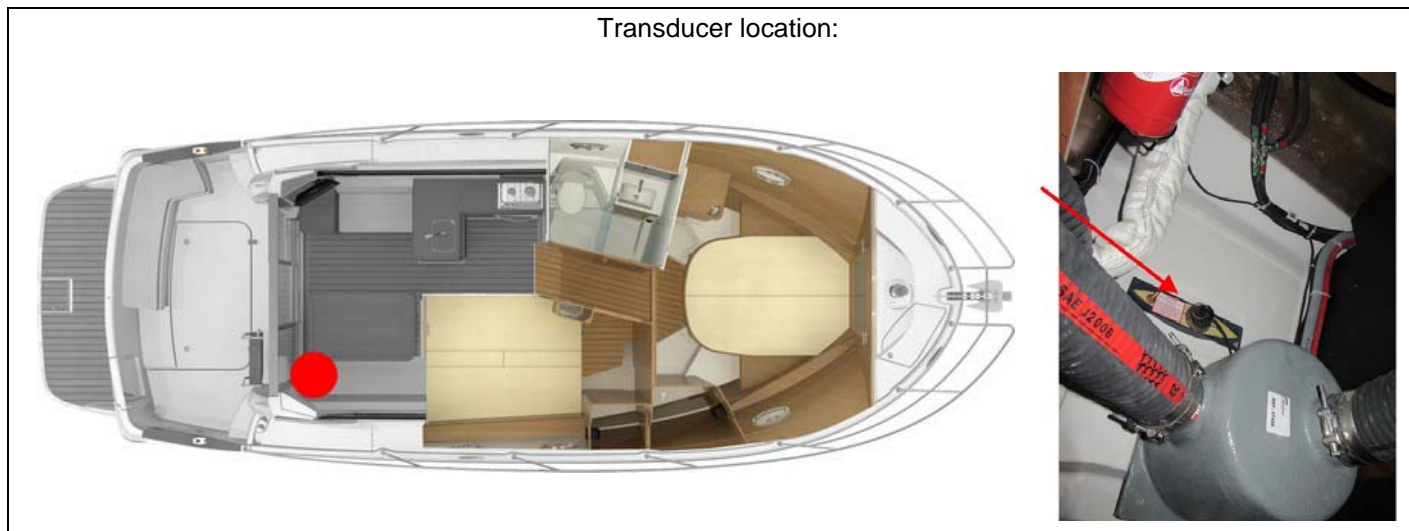

## Auto pilot

- To ensure optimum performance, keep all metallic objects away from the gyrocompass.
- Do not store material close to the calculator and electrical connections.

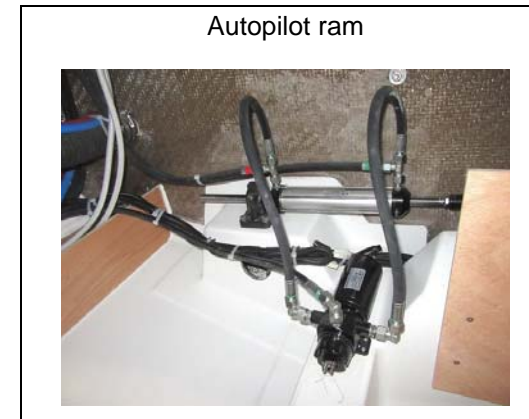
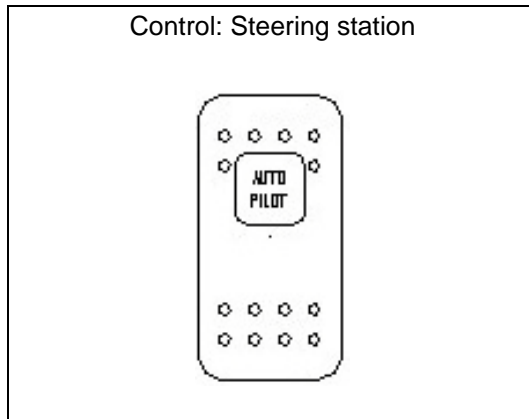

## VHF

### Layout of components:

Interior steering station



Flying bridge steering station



- Place the protective covers on the repeaters when unused for long periods.
- When sailing store the protective covers inside the boat to avoid losing them.
- The various repeater displays are back-lit.
- Regularly clean the fascias of the repeaters with fresh water.
- Refer to the manufacturer's instructions for use and maintenance.

### 11.3 EQUIPMENT OTHER THAN FOR PROPULSION, WHICH BURNS FUEL (GENERATOR, HEATING)

#### 11.3.1 General points

- Make sure that the ventilation openings in the engine (and generator, if installed) compartment are well cleared.
- Stop the engine and refrain from smoking during fuel tank filling.
- Get your fuel circuit checked regularly by a professional engineer.
- Avoid any contact between inflammable materials and the hot sections of the engine.
- Take all necessary precautions to avoid contact with naked flames and other hot areas.
- Do not obstruct or modify the ventilation system.
- Fuel stored outside the tanks (jerrycans, portable fuel tanks, etc.) must be stowed on deck, protected from bad weather and mechanical damage.



- Never store fuel tanks or tanks containing petrol in any area not specifically designed for storing petrol.

### 11.3.2 Generator

LAYOUT DIAGRAM

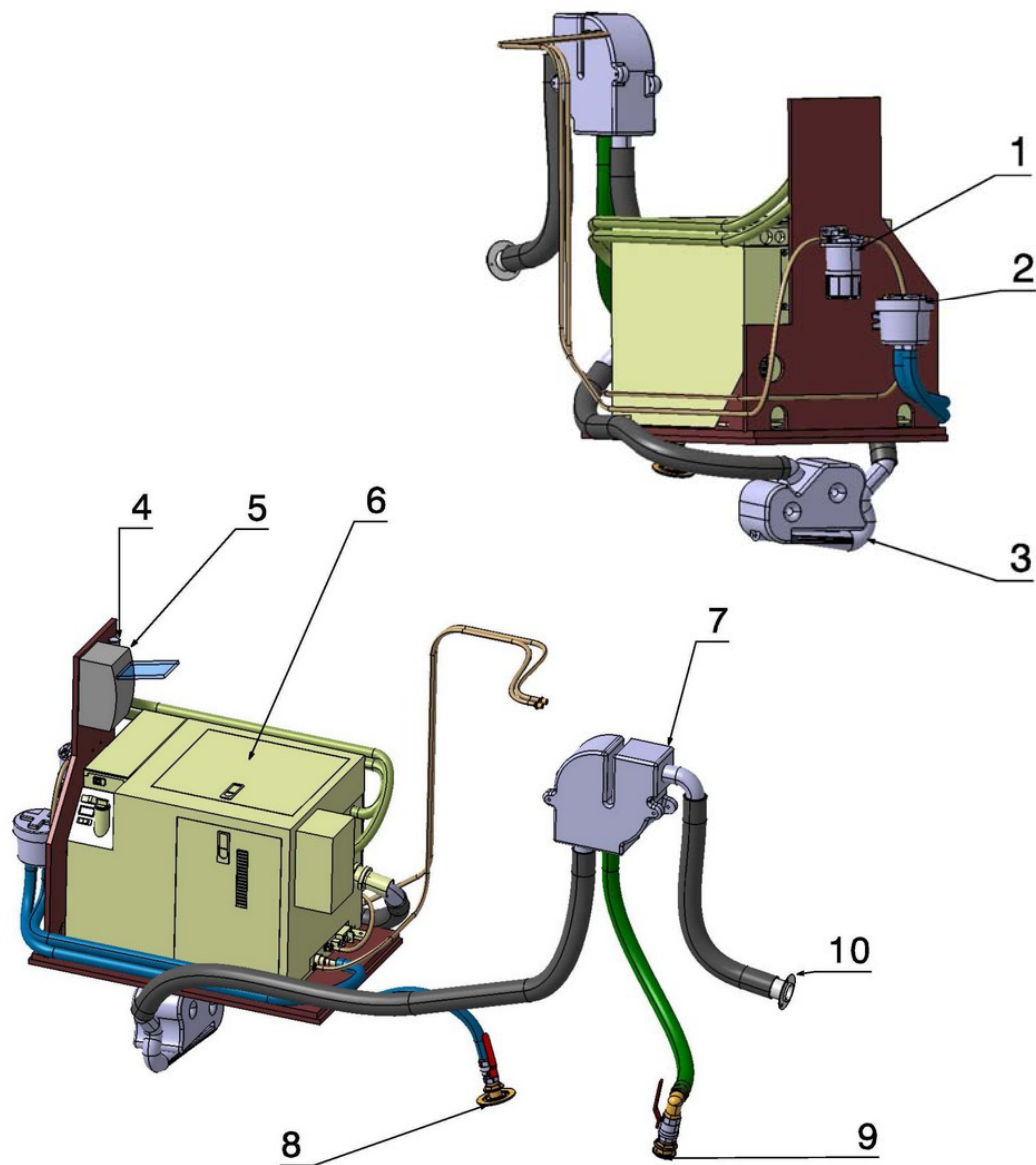

Reference	Designation
1	Fuel filter
2	Sea water filter
3	Water trap
4	Anti-siphon valve
5	Differential circuit breaker
6	Generator
7	Water - Gas separator
8	Seawater inlet
9	Seawater discharge
10	Outlet



### General points

- The generator is a machine which can produce AC electrical power using mechanical power (fuel). The generator will feed the onboard equipment operating at 220V or 110V, moored or sailing.
- The generator starts with its own battery (12 V circuit).
- Make sure that there is enough fuel in the fuel tank before using the generator. The generator is fed by fuel through the fuel tank port.
- The cooling water and exhaust gases are separated in the separator to avoid noise pollution. The seawater is discharged below the waterline. The exhaust- pipe is located above the waterline. Check visually that the exhaust gases are being expelled properly. Make sure that the ventilator in the generator compartment is working.
- Check to see if any leaks appear (sea water, coolant, fuel, exhaust gases). If there is a leak, stop the generator at once and get the leak repaired.
- The generator is earthed by an earthing plate which is located under the hull (see earthing plate chapter).
- Maintenance of the generator must only be done by qualified and proficient personnel. Before working on the generator, it is imperative to isolate the generator's battery power, to prevent it from starting accidentally.
- The generator can be started by the switch on the generator or by the switch on the control panel.

### Starting up

- Open the raw water intake valves and evacuation valves.
- Open the fuel supply valve.
- Turn the generator's battery switch to the ON position.
- Switch the generator's circuit-breaker to the ON position.
- Turn on the generator using the remote control (located near the main switch panel).  
or on the generator itself.
- Make sure that no AC equipment is running. Then set the shore power/ generator switch.

In the event of the generator catching fire

- Don't open it.
- Cut the supply (electrical and fuel) to the boat's engines, to the generator and to the ventilators.
- Use the extinguisher access port on the generator to discharge the contents of the portable extinguisher.



- Please refer to the manufacturer's instructions for using the generator.
  - Never start the generator when the climate function is already on. Always turn off the air conditioning before turning off the generator.
  - Never connect the shore power to the generator: danger of electric shock.
  - An extinguisher access port is provided on the generator to put out a fire starting in the generator.

### 11.3.3 Warm air heating system

#### General points

- The heating is powered by DC supply. The electrical supply is provided by the onboard battery bank.
- A fuse protects the circuit.
- You are advised to run the heating system for about 15 minutes every month (to prevent the operating components from becoming blocked/to refresh the fuel in the pipeline).
- The warm air heating system, installed at the back of the boat draws in the air outside via an integrated ventilator.
- The air warmed in the heating system is blown through the warm air ducts to the living area of the boat.
- The fuel is supplied via a feed pump by the fuel tank.
- The combustion system is separate from the heating system: The air intake for combustion is separate from the warm air heating system.
- The exhaust gases are expelled outside by an exhaust pipe with a silencer.
- The heating system compares the actual temperature with the desired temperature and automatically adjusts the heating power required.

#### Annual maintenance

- Clean or replace the fuel filter.
- Check that the heating ducts are in good condition.

### Manual control

Location: Saloon

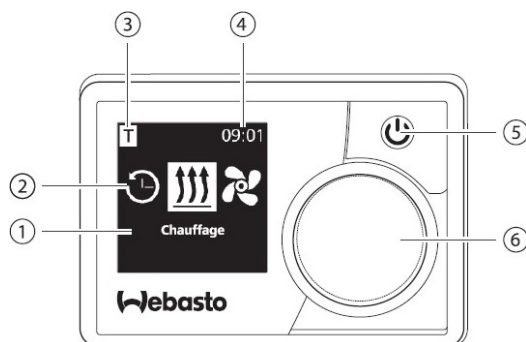

1. Name of menu element
2. Menu symbol
3. Preset duration activated
4. Clock
5. ON / OFF control button
6. Control button (rotating and push button) to choose and confirm the desired function

The colour of the ON / OFF start button indicated the heating appliance status:

- continuous green: Heating
- continuous blue: Ventilation
- continuous white: Boiler off
- flashing red: Faults / no heating
- flashing green: Pre-programmed heating
- flashing blue: Pre-programmed ventilation



































- Please refer to the manufacturer's instructions for the use and maintenance of the heating system.

- A sudden cut in the electrical supply risks damaging the heater: **REMEMBER TO SWITCH OFF THE HEATER BEFORE ISOLATING THE BATTERIES.**

- It is imperative to disconnect the electrical supply and to allow the hot components to cool before doing any maintenance or work on the heater.

## DESCRIPTION OF PICTOGRAMS

	Timer menu		Ventilation menu
	Heating menu		Settings menu
	Normal heating mode		Eco heating mode
	Boost heating mode		Ventilation speed (speeds 1 to 4)
	Add the time programmer		Activate the time programmer
	Deactivate the time programmer		Delete the time programmer
	Delete all time programmers		Time programmer activated
	Instant starting		Day of the week
	Hour		Language
	Unit of temperature		Day / Night
	System information		Error information
	Reset (reset / return)		Repair - Please contact the repair and maintenance centre
	Left		Warning
	Return		Right
	12-hour display		OK
	Switched on		ADR

## LAYOUT DIAGRAM

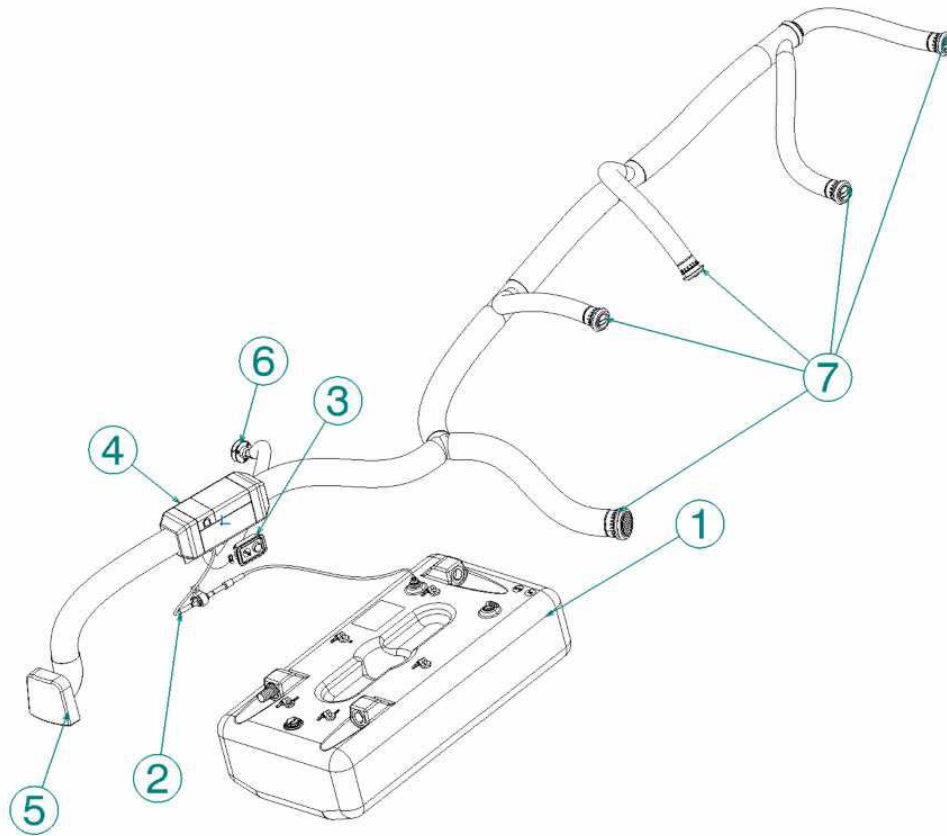

Reference	Designation
1	Diesel tank
2	Metering pump
3	Control box
4	Heater
5	Fresh air intake
6	Heating exhaust
7	Hot air openings



- The heater must be switched off when refilling the fuel tank.
- The heater's exhaust gases are very hot: they risk burning the shock mounts or the cables running too close to the exhaust outlet skin fitting.

## LAYOUT OF COMPONENTS

Sensor



Heater  
Location: Engine compartment



Fuel supply valve  
(Starboard tank)







## WATER SYSTEMS

■ General points .....	110
■ Using a valve.....	111
■ Fresh water filling system .....	112
■ Fresh water distribution system .....	114
■ Main plumbing equipment.....	115
■ Black water system (WC).....	119
■ Waste water system .....	124

## 12.1 GENERAL POINTS

- It is essential to rinse the entire on-board water system the first time the boat is used (The water system is protected in the factory by a dietary anti-freeze).
- The water tanks may have had an anti-algae treatment using a copper sulphate based product. It is advisable to renew the treatment according to the area in which the boat is sailing.
- Drain all the water systems during winterisation (in particular the cockpit shower and water heater) to avoid damage from freezing.
- Clean/change the filters regularly.



- Regularly check water-tightness of joints in the water system installations. Check that screws and bolts are well tightened and replace them if they are worn or corroded.
- Disconnect shore water supply before leaving the boat (if fitted).
- If the boat is sailing in temperatures below freezing, it is possible to use anti-freeze in the water systems: use a non-toxic anti-freeze marked for dietary use.

**NEVER USE AUTOMOBILE ANTI-FREEZE:  
RISK OF POISONING.**

## 12.2 USING A VALVE

The valve is shut when the valve handle is at right angles to the pipe, the valve is open when the valve handle is in line with the pipe.

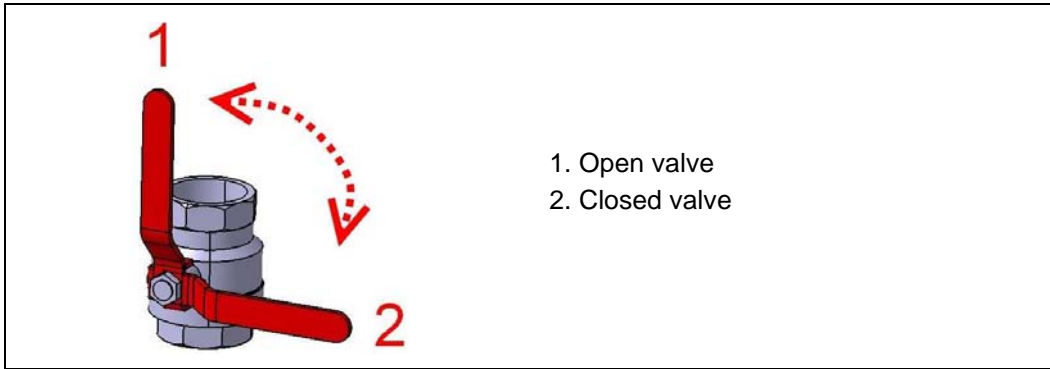

### Using the drainage valve

- The direct drainage to the sea valve can be plumbed by means of the drilled hole on the handle.
- Blockage of the drainage valve in closed position: Pass the tightening collar around the drainage valve and in the hole in the handle.

Plastic valve



Bronze valve



 The valves, through-hull and other brass accessories last for about 5 years. Have all valves, hull orifices and other brass accessories of the vessel professionally checked every 5 years and replace them as necessary.

 - Beware of any draining by inadvertence.

### 12.3 FRESH WATER FILLING SYSTEM

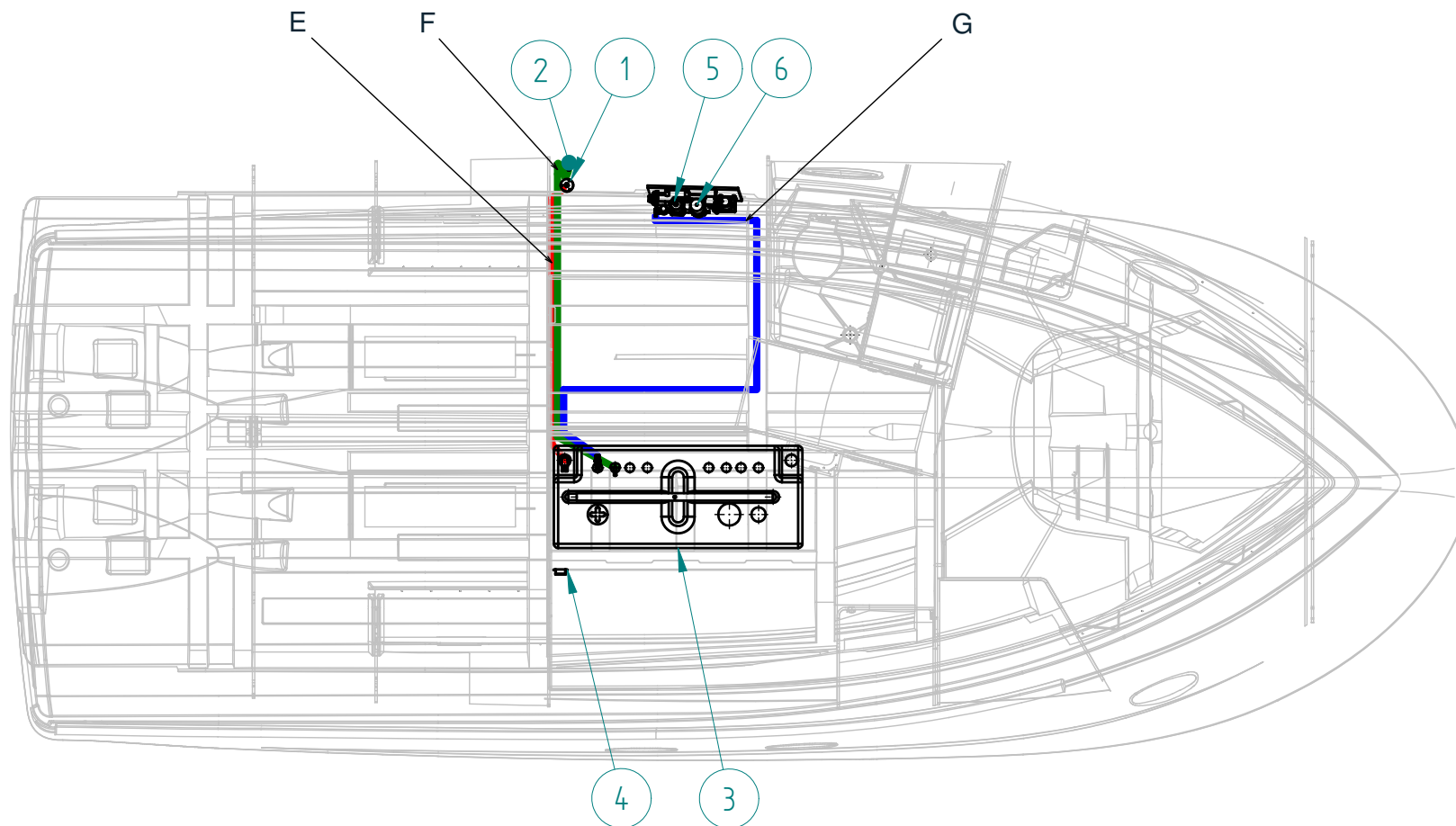

Reference	Designation
1	Water tank filler
2	Water tank vent
3	Water tank
4	Gauge electrical unit
5	Fresh water filter
6	Water unit

Reference	Designation
E	Tank filling
F	Vent hole
G	Hot water/cold water distribution bundle

Water tank  
Location: Aft cabin



Gauge  
Location: Passageway



## 12.4 FRESH WATER DISTRIBUTION SYSTEM

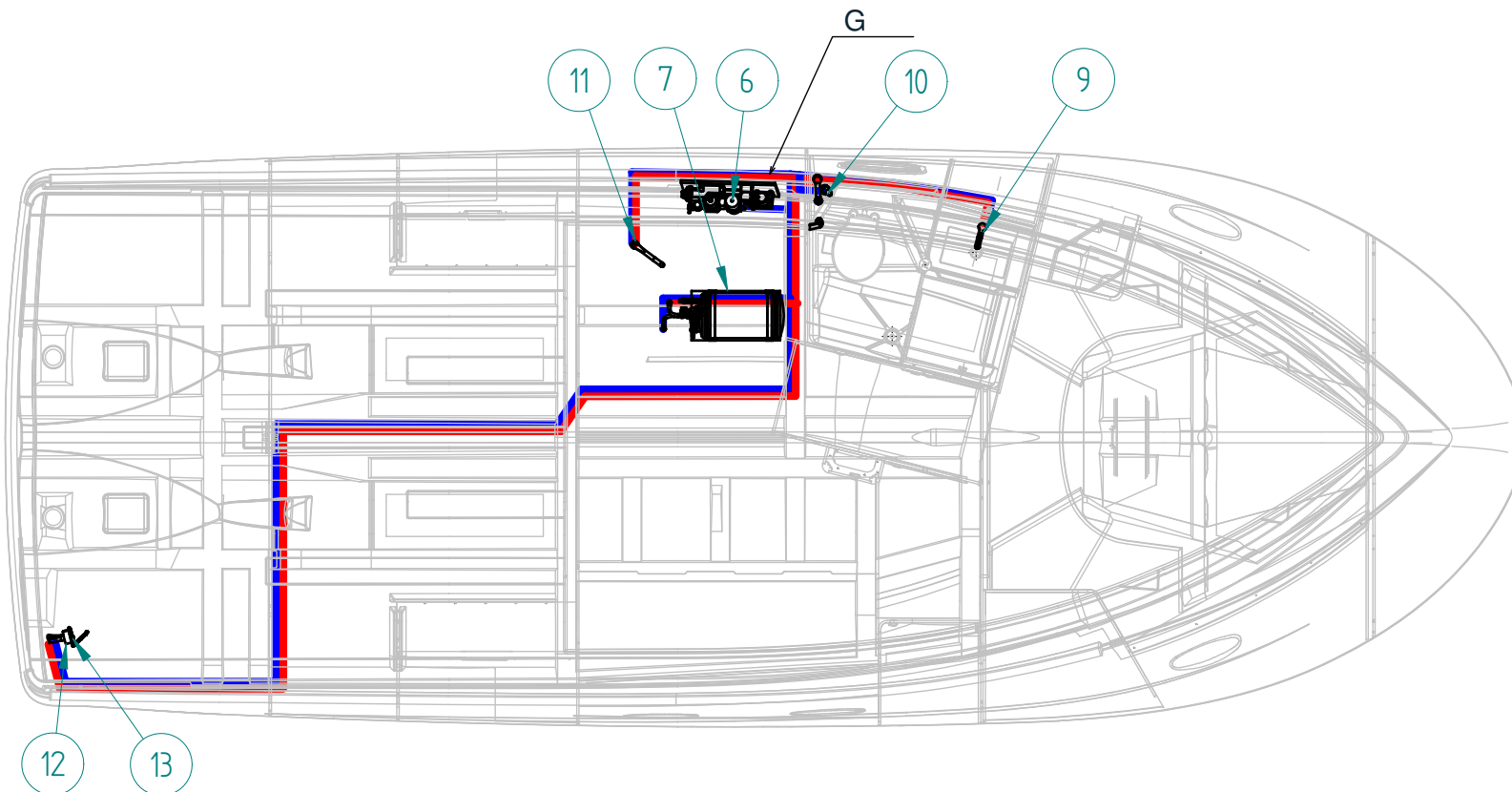

Reference	Designation
6	Water unit
7	Water heater
9	Washbasin mixer tap
10	Mixer shower
11	Sink mixer tap
12	Cockpit shower
13	Cockpit shower mixer tap

Reference	Designation
G	Hot water/cold water distribution bundle

## 12.5 MAIN PLUMBING EQUIPMENT

### 12.5.1 Water unit

- The water unit is supplied by direct current.
- It serves to feed all the boat's plumbing equipment with fresh water. It is fitted with a pressure switch that activates the flow when the pressure in the water system falls.
- The water unit must only be used with the fresh water supply. All other use (with sea water or bilge water, with oil products) is prohibited.
- The water pump is switched on at the helm station.
- Make sure that the water unit is never run dry.
- The pressure and capacity of the water unit depend on the temperature of the stored fresh water supply.

Control: Steering station

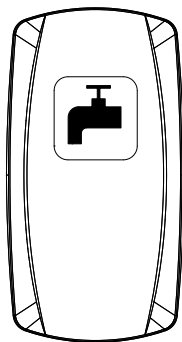

Location: Aft cabin



1. Filter
2. Water unit
3. Expansion tank

### 12.5.2 Cockpit shower

- The cockpit shower allows the use of fresh water for rinsing off.
- The shower is fitted with a mixer tap.
- The tap has a dual function:
  - It allows the water to be turned on/off,
  - It allows a choice of water temperature (hot water / Cold water).

#### Operation

- To use the shower, turn on the water by tipping the tap on its axis.
- Then press the button on the top of the shower to allow the flow of water.
- Choose the required temperature by turning the tap clockwise or anti-clockwise.
- After using the shower, it is important to turn off the water by tipping the tap on its axis.

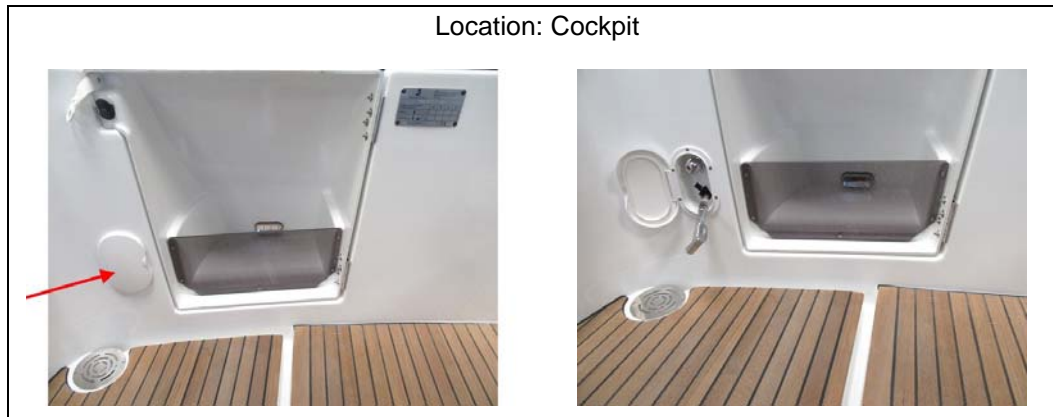



### 12.5.3 Deck wash pump

- The deck wash pump is supplied by direct current.
- The deck wash pump allows the deck or the boat's tender to be washed.
- The deck wash pump is switched on at the helm station.

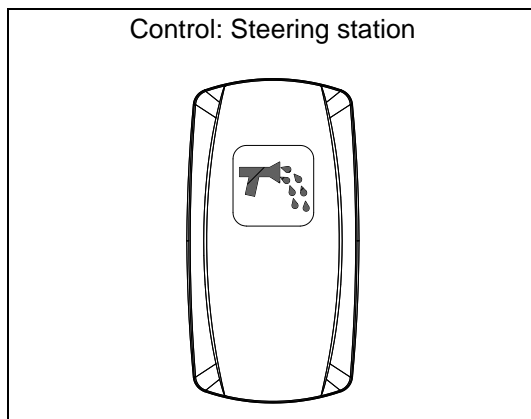

#### Operation



- Open the sea water intake valve.
- Select sea water/fresh water supply.
- Attach a hose to the connector provided in the cockpit.
- Start the pump.

#### 12.5.4 Water heater

- The water heater allows the use of hot water on board the boat.
- The water heater operates by recovering heat from the port/starboard engine cooling system or via the onboard AC electrical system.
- The water heater thermostat regulates the water temperature only when it is operating with electrical resistance. The thermostat is pre-set in the factory.
- The mixer tap allows the temperature leaving the water heater to be adjusted.
- Never switch on the water heater if it is not filled with water.
- A valve allows the water heater to be connected to the heat exchanger. This valve allows you to isolate a faulty circuit.

Location: Aft cabin



1. Water heater (25 L)
2. Mixer tap

Location: Aft cabin



## 12.6 BLACK WATER SYSTEM (WC)

### General points

- Black water is human waste including the flushing water from the toilets.
- Close the valves after each use and above all when the boat is unattended.
- Regularly check the valves and thru-hull seacocks for proper operation and watertightness.
- Regularly check the tightness of the flexible pipe clamps and connections.

### **YOUR BOAT IS FITTED WITH A BLACK WATER TANK**

To minimise the smells coming from this tank, we advise the following use and maintenance:

#### 1) Holding tank

- A black water tank is used solely for the temporary collection of water coming from the toilets.
- The tank can be emptied in 2 ways:
  - By connection to a pumping system that empties the tank by suction. This system uses the "WASTE" deck connection.
  - Via the thru-hull fitting emptying directly into the sea (under the conditions permitted by the laws of the country in which the vessel sails, if they permit dumping into the sea).
- Only use water soluble toilet paper to avoid any blockage.

*Note: Sanitary towels and other items (paper handkerchiefs, dressings etc) in the toilets and black water tank will inevitably lead to blockages.*

- Faecal matter causes formation of unpleasant odours in the black water tanks, to which the use of salt water for flushing the toilets also contributes. Algae present in salt water also give off unpleasant odours.
- Completely empty the black water system before leaving the vessel unattended in temperatures below freezing.
- Ask for information about the laws in force in your country or your marina about discharging your waste waters into the sea.

#### 2) Use of toilets

- Every time the toilets are used, flush afterwards with copious amounts of water in the bowl using the toilet pump (manual or electric).
- When you are leaving the boat for several days, flush with fresh water, using for example the head's shower. Sea water that stagnates in the bowl gives off bad smells.

### 3) Maintenance of black water tank

- The risk of unpleasant odours forming increases when the waste water remains in the tank for a long time.
- Whenever possible empty the tank regularly even before it is full.
- Every time the tank is emptied put in about 5 litres of fresh water and add an appropriate detergent additive (available from chandleries). A very simple method is soda salts, which clean and disinfect at the same time.
- Before winterising, flush the tank with copious amounts of fresh water filling it through the 'WASTE' deck connection. Leave at least 5 litres of fresh water mixed with a detergent additive.
- Disinfecting: Disinfect the tank once a year by filling it with a solution of Javel water (1 to 1000).

### 4) Using the drainage valve

- The direct drainage to the sea valve can be plumbed by means of the drilled hole on the handle.
- Blockage of the drainage valve in closed position: Pass the tightening collar around the drainage valve and in the hole in the handle.

Bronze valve



Location: Head (under the washbasin)

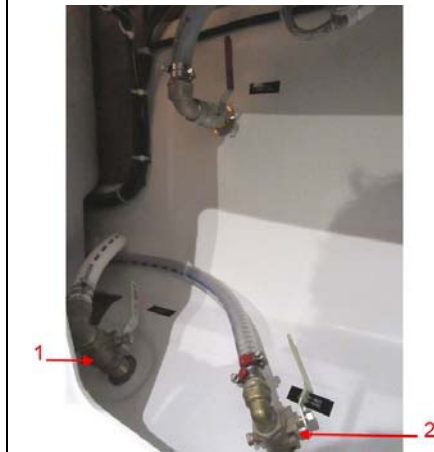

1. Black water drainage tank
2. WC seawater intake



Never use automobile anti-freeze in the black water system: risk of poisoning.



Respect local regulations regarding the emptying of black water tanks.



- Beware of any draining by inadvertence.

Layout diagram of black water system  
 Drainage by electric pump DC (Masher)

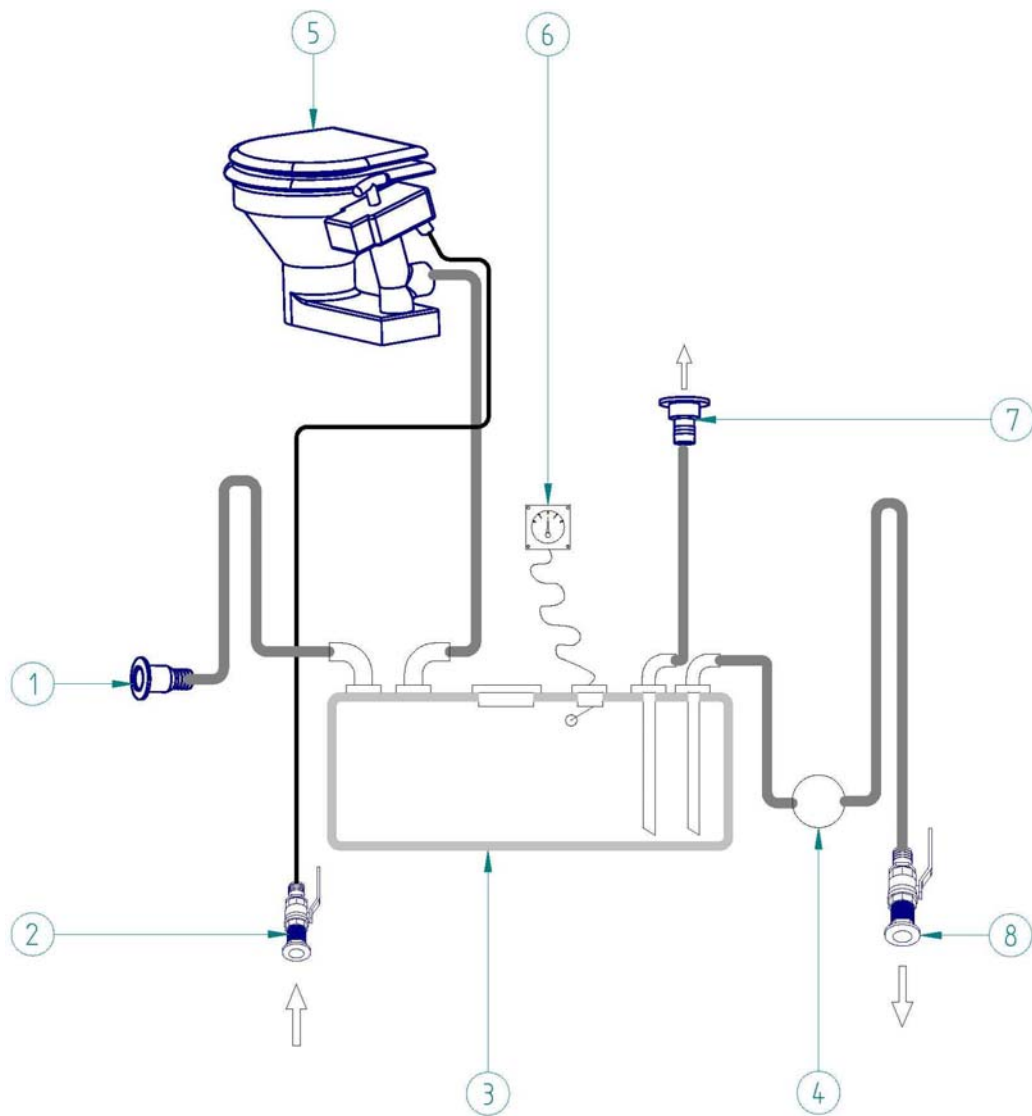

Reference	Designation
1	Vent hole
2	Seawater intake valve
3	Black water tank
4	Masher (WC drainage pump)
5	WC
6	Gauge
7	"WASTE" deck connection
8	Sea discharge valve

### **Using a marine toilet with a tank drain by macerator**

- I. Open the sea water intake valve (Ref 2).
- II. Fill the bowl by using the manual toilet pump.
- III. Using the toilet (Ref 5).
- IV.a. To empty the organic waste in the tank:
  - Make sure the thru-hull seacock (Ref 8) is closed.
  - Empty the bowl using the manual toilet pump.
- IV.b. In the case of a direct discharge into the sea:
  - Open the thru-hull seacock (Ref 8).
  - Empty the bowl using the manual toilet pump.
  - Empty the tank by switching the electric pump (Ref 4).
- IV.c. To discharge through the deck:
  - Open the deck connection marked "WASTE" (Ref 7).
  - Use the pump-out system where fitted at a port.

### **Use of a DC electric toilet has a tank-discharge macerator**

- I. Open the sea water intake valve (Ref 2).
- II. Fill the bowl by pressing the fill button.
- III. Using the toilet (Ref 5).
- IV.a. To empty the organic waste in the tank:
  - Make sure the thru-hull seacock (Ref 8) is closed.
  - Empty the bowl by pressing the empty button.
- IV.b. In the case of a direct discharge into the sea:
  - Open the thru-hull seacock (Ref 8).
  - Empty the bowl by pressing the empty button.
  - Empty the tank by switching the electric pump (Ref 4).
- IV.c. To discharge through the deck:
  - Open the deck connection marked "WASTE" (Ref 7).
  - Use the pump-out system where fitted at a port.



Refer to the manufacturer's instructions for use and maintenance.

## LAYOUT OF COMPONENTS

Black water tank  
Location: Aft cabin



Black water tank gauge  
Location: Head



Masher (WC drainage pump)  
located directly on the tank



Masher control



**NOTE: It is essential to open the toilet discharge valve at sea BEFORE activating the discharge pump.**

Electric toilet control



Pump sea water - Electric toilet  
Location: Aft cabin



1. Pump sea water
2. Sea water filter

## 12.7 WASTE WATER SYSTEM

### General points

- The waste water system is the water coming from the sink, showers, air conditioning drains and washbasins.
- Close the valves after each use and above all when the boat is unattended.
- Regularly check the valves and thru-hull seacocks for proper operation and watertightness.
- Regularly check the tightness of the flexible pipe clamps and connections.

### Use of the waste water tank

- A sensor with automatic pump activation enables the tank contents to be emptied. If the house electricity system is off the tank will not empty.
- When the DC supply light shows, a 3 -minute drainage cycle automatically starts up.



Observe local regulations regarding the emptying of grey water tanks.



### 12.7.1 Diagram of waste water circuit installation

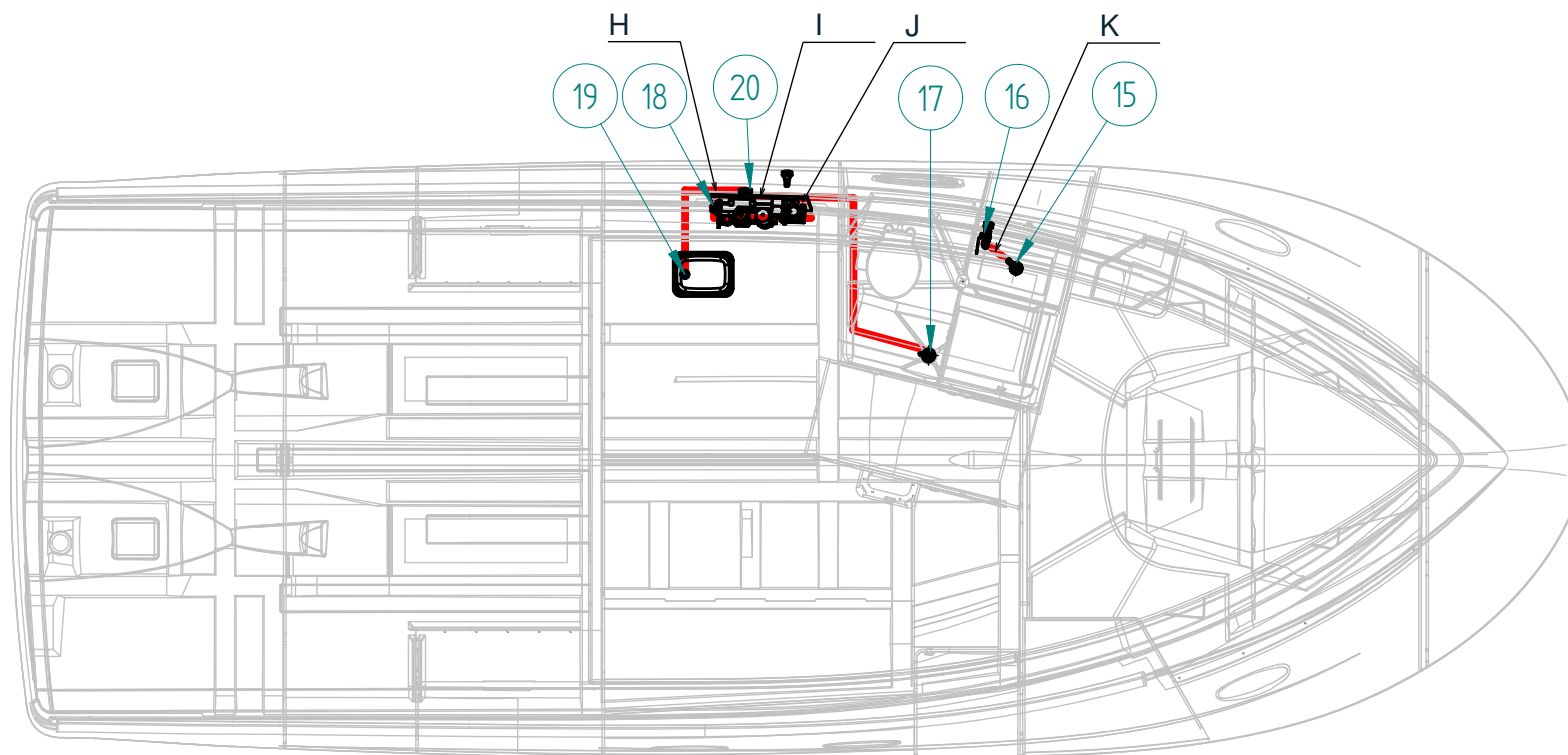

Reference	Designation
15	Washbasin drain plug
16	Washbasin drain valve
17	Shower plug hole
18	Shower pump
19	Sink plug hole
20	Sink drainage valve

Reference	Designation
H	Sink drain to through-hull
I	Shower tray draining (Electric pump)
J	Shower pump drain to Y
K	Through-hull washbasin drain

## 12.7.2 Waste water tank installation diagram

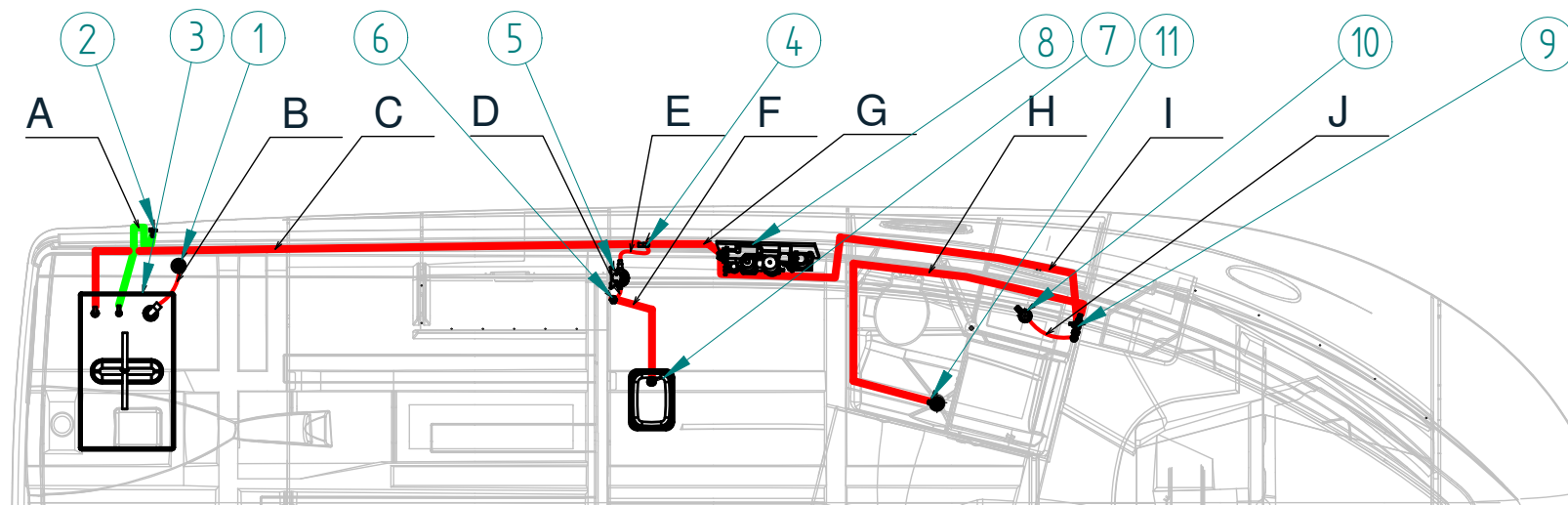

Reference	Designation
1	Water tank filler
2	Water tank vent
3	Water tank
4	Gauge electrical unit
5	Fresh water filter
6	Water unit
7	Water heater
8	Boiler draining
9	Washbasin mixer tap
10	Mixer shower
11	Sink mixer tap

Reference	Designation
A	Plunger
B	Vent hole
C	Inspection hatch
D	Water level loom - 5 points
E	Tank filling
F	Vent hole
G	Hot water/cold water distribution bundle
H	Sink drain to through-hull
I	Shower tray draining (Electric pump)
J	Shower pump drain to Y

## LAYOUT OF COMPONENTS

Shower plug hole



The shower pump control



Shower pump  
Location: Aft cabin



Shower screen



***NOTE: Must be secured while sailing.***



## ENGINE

■ Information about the risks of fire and of explosion of engines	130
■ Danger from moving mechanical parts .....	131
■ General points .....	131
■ Starting the engine .....	134
■ Engine water intake valve.....	135
■ Fuel filter .....	136
■ Engine installation.....	137
■ Engine control .....	140
■ Access to the engine.....	141
■ Flaps .....	141
■ Propeller shaft .....	144
■ Stuffing box.....	145
■ Propeller .....	145

### 13.1 INFORMATION ABOUT THE RISKS OF FIRE AND OF EXPLOSION OF ENGINES

- Make sure that the coolant is circulating properly.
- Ensure that the engine compartment ventilation air inlets are kept clear.
- Stop the engine and refrain from smoking during fuel tank filling.
- Get your fuel circuit checked regularly by a professional engineer.
- Avoid any contact between inflammable materials and the hot sections of the engine.
- Never switch off or de-energise the electric system when the engine is running.
- Never block the access of the fuel supply valve.
- Do not obstruct or modify the ventilation system.
- Never turn the engine over when the boat is on land.
- Fuel stored outside the tanks (jerrycans, portable fuel tanks, etc.) must be stowed on deck, protected from bad weather and mechanical damage.
- Regularly check that the engine compartment is clean and dry.

Engine water intake valve:  
Location: Cockpit locker



Fuel supply valve  
located directly on the tank



### 13.2 DANGER FROM MOVING MECHANICAL PARTS

- Keep away from the moving parts of the engine (belts and moving parts or hot components) and the drive shafts etc..
- Be careful if you have long hair, bulky clothing, rings etc (at risk of being caught).

### 13.3 GENERAL POINTS

- Don't install an engine more powerful or heavier than recommended on this boat, this risks compromising the boat's stability.
- Make sure you have enough fuel before sailing.
- Stop the engine before opening the engine compartment.
- Don't close the fuel supply valve between each use of the engine (unless for a lengthy absence).
- Get the whole propulsion system checked at least once a year by a professional engineer.

See the chapter on "Manoeuvrability".

**Always start the engine with the control lever in neutral.**



- Regularly check that the O ring on the filler cap is in good condition, to prevent any water ingress.
- Keep the fuel tank as full as possible to prevent condensation.
- Be careful with any possible risk of oil and fuel spillage.
- Follow the engine manufacturer's instructions exactly.
- **Never switch off the battery breakers when the boat's engine is running (risk of serious damage to the charging circuit).**

### Type of motorisation

Your boat is fitted with two in-board diesel engines.

The transmission is of a shaftline type.

### Filling up with fuel

- Fill the fuel tank using the "PETROL"/"DIESEL" deck filler provided for this.
- Regularly check that the O ring on the filler cap is in good condition, to prevent any water ingress.
- Each fuel supply valve supplies one engine.
- The generator has its own fuel supply valve.

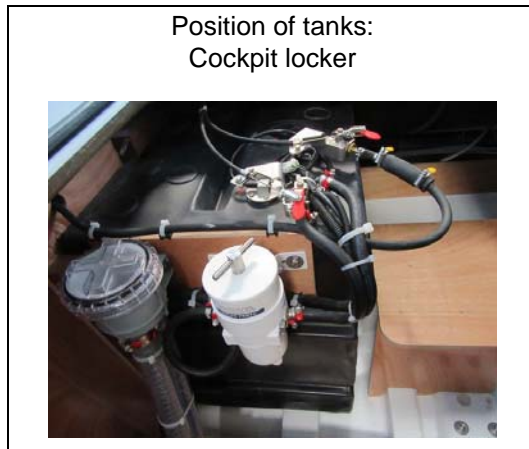

### Tank interconnecting valve

- A valve enables the two tanks to be interconnected.
- Keep the 2 interconnection valves closed at all times to avoid the transfer of fuel from one tank to the other (risk of emptying one tank and disabling one engine).
- Open the interconnection valves only to balance the tanks or if there is a problem with the fuel supply.



## Gauge

- The fuel level is given by the gauge to the indicator on the steering station.
- Some of the gauges must be calibrated when you first fill the tanks: please consult your dealer.

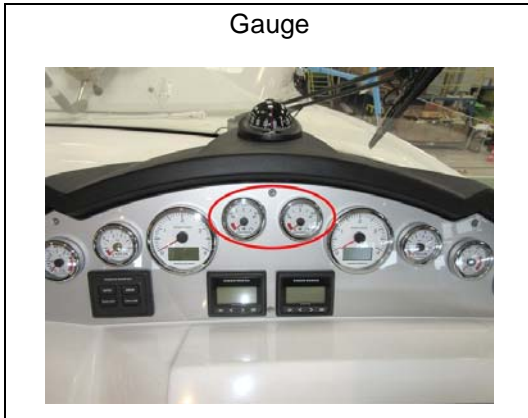

 The tanks' nominal capacity cannot be fully used due to the load and the need to maintain the correct trim. A 20% reserve should be kept.

### 13.4 STARTING THE ENGINE

Before starting the engine, it is imperative:

- to open the fuel supply valve;
- to open the sea water intake valve of the engine;
- to open the sea water intake seacock for the stern gland;
- to switch on the battery supply by using the battery isolator switches;
- to put the control lever in neutral.

Make a habit of looking to see if sea water is pumped out with the exhaust gases as soon as you start the engine. If no water runs out, stop the engine immediately. Check the coolant flow.

As soon as the engine starts, the engine compartment bilge fan operates.



Before using the engine, make sure you carefully read the handbook provided by the engine manufacturer.



- Always start the engine with the control lever in neutral.
- Learn how to judge the necessary distance of deceleration for the vessel to come to a complete stop (The reverse gear is not a brake).

### 13.5 ENGINE WATER INTAKE VALVE

The sea water intake valve plays a crucial role in ensuring that the engine runs well.

- Keep the strainer under the hull as clean as possible;
- brush the strainer whenever the boat is lifted out.

This valve must absolutely always be opened before starting the engine.

A sea water filter filters the water before it goes through the heat exchanger.

Regularly inspect the sea water filter and clean it if necessary. Screw/unscrew the cover of the filter by hand (never use tools for this).

For lengthy absences, close the engine's sea water intake valve.

Sea water intake



Sea water filter



### 13.6 FUEL FILTER

Engine running problems may have different origins, including dirty fuel. The injection pump may wear out if there is water in the system. The water results either from the condensation resulting from an insufficiently filled tank, or from a filler cap either not closed properly or with a damaged seal.

In order to prevent any water infiltration, the fuel runs through two filters:

- One filter is an integral part of the engine, its role is to filter fuel very finely. Please refer to the engine manufacturer's notes for any maintenance and for the frequency of filter changes.
- The second filter is on the pipe that links the tank to the engine, it plays the role of a water decanter and prefilter.

#### Maintenance

- Purge the impurities by unscrewing the screw located at the base of the decanting bowl (without removing it). Let the liquid run into a receptacle until the fuel runs clear. Do this several times a year.
- Change the pre-filter at least once a year.



### 13.7 ENGINE INSTALLATION

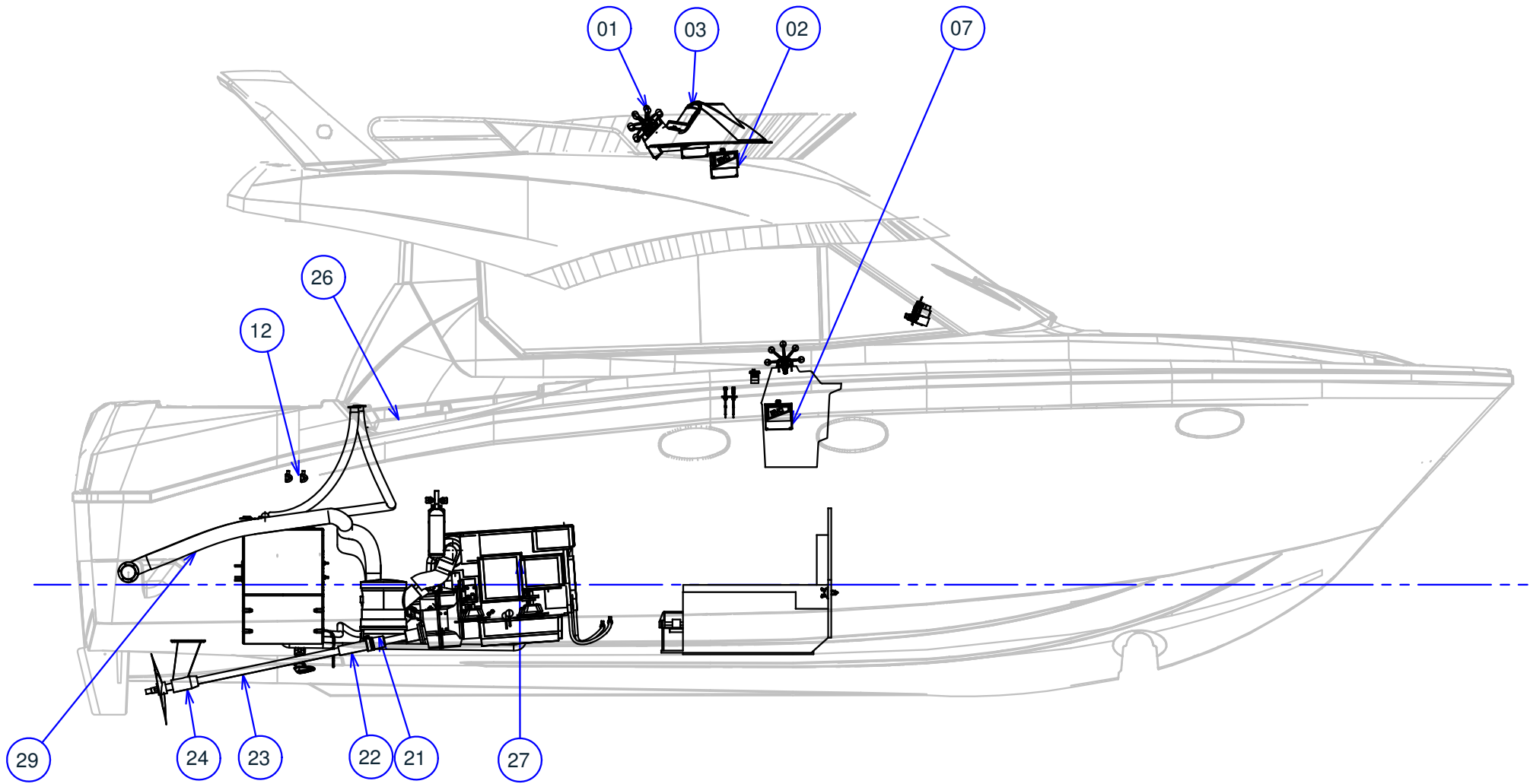

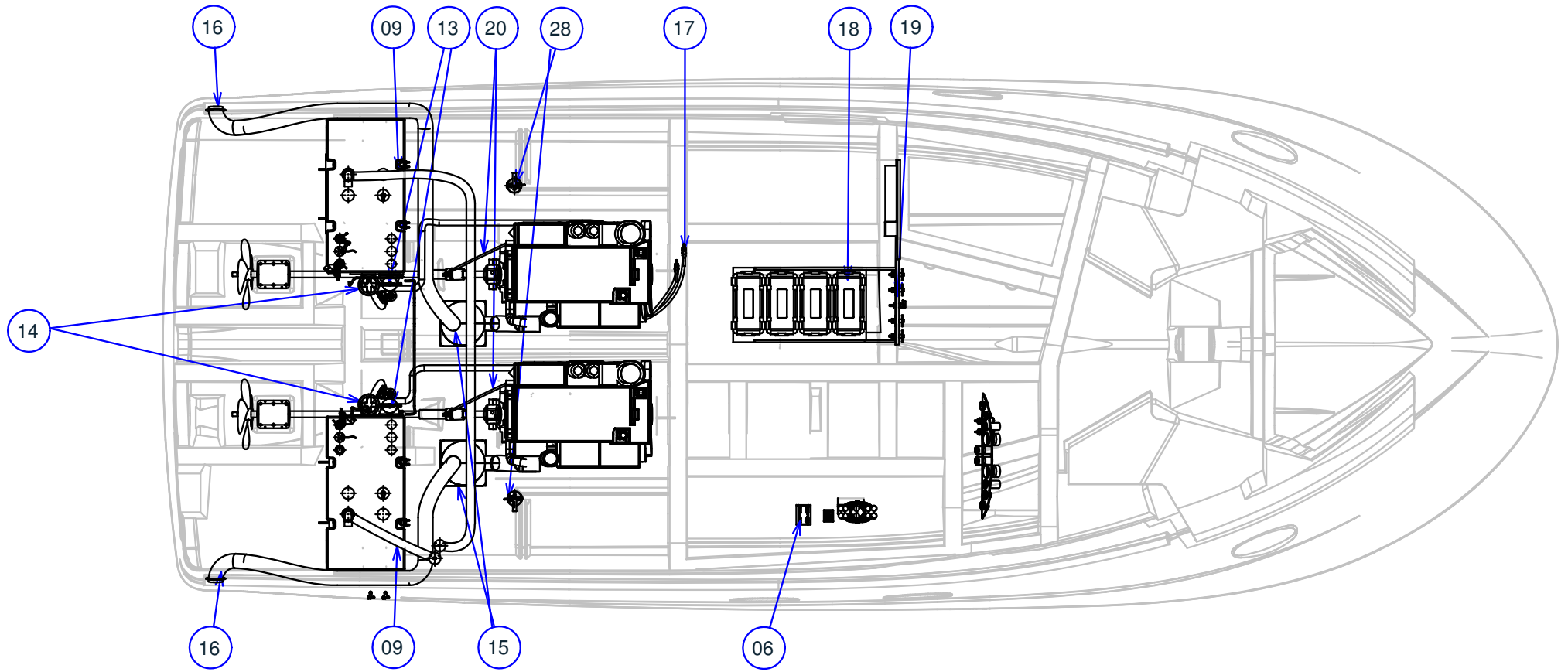

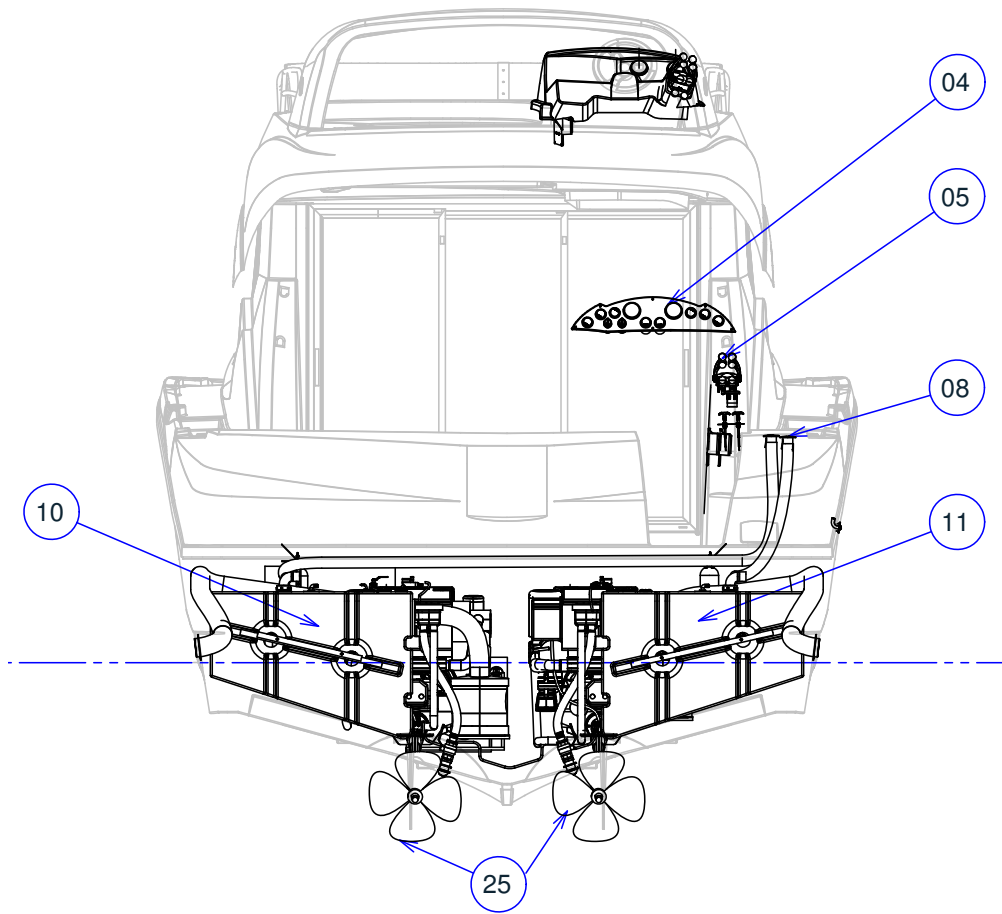

Reference	Designation
1	Engine control lever - Flying bridge steering station
2	Box Electronics Engine - Flying bridge steering station
3	Flying bridge steering station
4	Interior steering station
5	Engine control lever - Interior steering station
6	Extinguisher remote control + Remote control - Supply valve: Fuel
7	Box Electronics Engine - Interior steering station
8	Filler cap
9	Pipe Filling
10	Fuel tank Port side
11	Fuel tank Starboard
12	Vents
13	Decanter filters
14	Sea water filter + Seawater inlet
15	Water trap
16	Exhaust outlet
17	Valve By-pass - System Water heater
18	Engine battery 110A
19	Engine battery switch
20	Joining Stern frame
21	Stuffing box 45mm
22	Stern frame
23	Propeller shaft
24	Bearing
25	Propeller
26	Fan
27	Motor
28	Fixed extinguisher
29	Exhaust pipe

## INSTALLATION OF SHAFT ENGINE WITH BRACKET

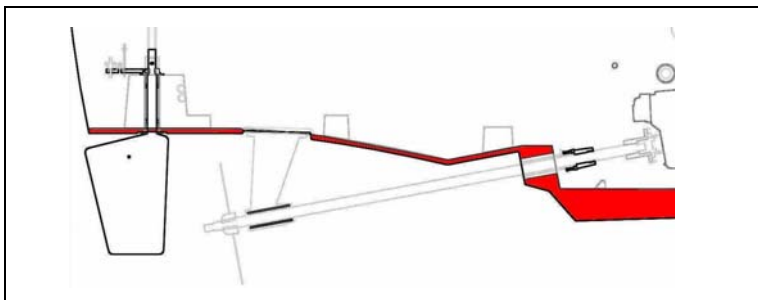

### 13.8 ENGINE CONTROL

- The engine manufacturer's notes provide detailed explanations on how to operate the engine and keep it running well.
- Read the manufacturer's notes on use and maintenance of the engine.

#### Control lever





### 13.9 ACCESS TO THE ENGINE

The access to the engine is via:

- The cockpit,
- Side hatches.

All access hatches to the engine absolutely must be kept shut when at sea.

### 13.10 FLAPS

#### General points

- The flaps (trim control system) allow the pilot to adjust the boat's trim under way and thus to reduce fuel consumption.
- The flaps run on DC power.
- A fuse protects the electrical circuit.
- They are operated by means of a push button situated on the wheelhouse and their position is adjustable.
- The flaps only work when the boat's engines are running.



- Refer to the manufacturer's instructions for use and maintenance.
- Adjust the flaps gradually to avoid abrupt hull movements. At high speeds, take care when adjusting the flaps.
- Lift the flaps completely in case of swell from abaft of the boat.

DIAGRAM OF THE LAYOUT

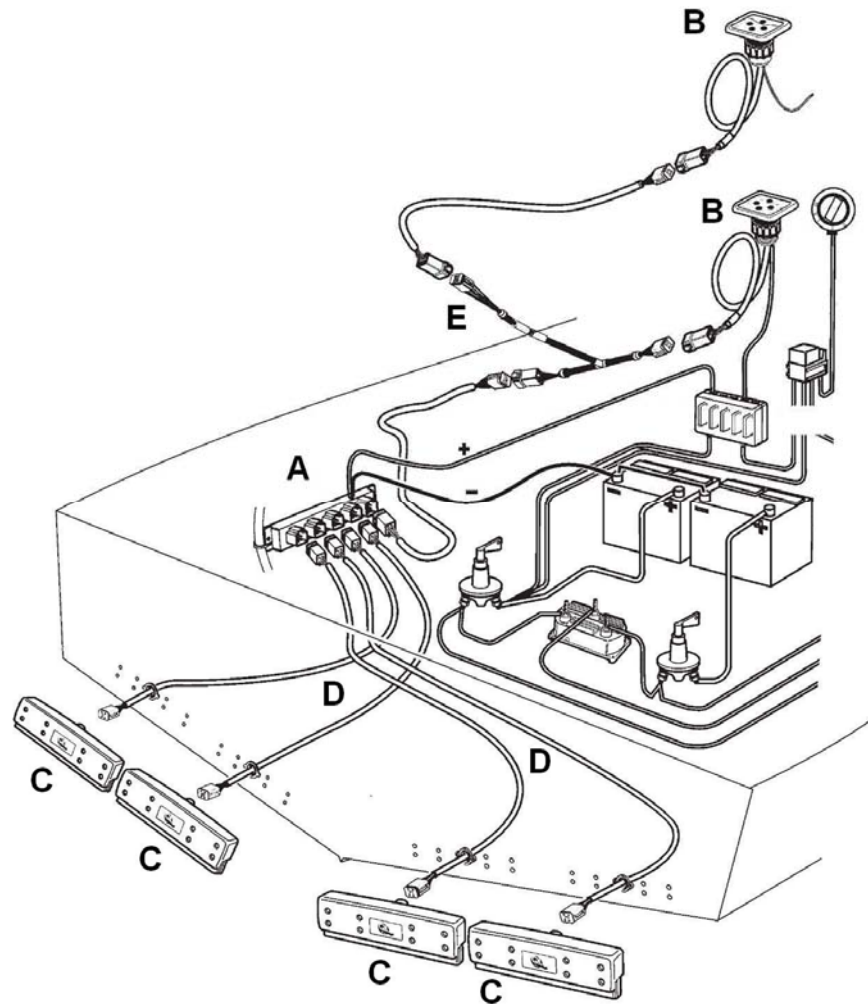

## Description of elements

A. The control unit represents the system's brain. It is located in the engine compartment.

B. The control panel for the flaps is located in the wheelhouse.

C. Interception units. Each interception unit includes an integral watertight joint.

D. E. Control cables

Control unit (A)

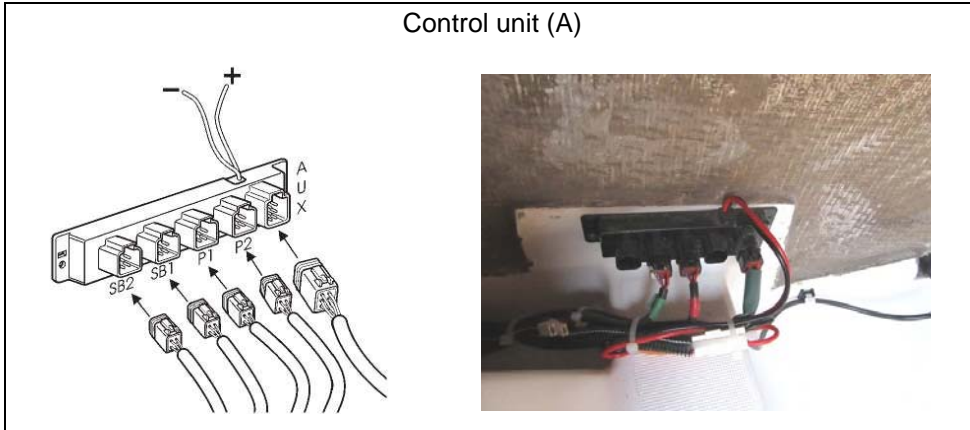

Flaps control panel (B)

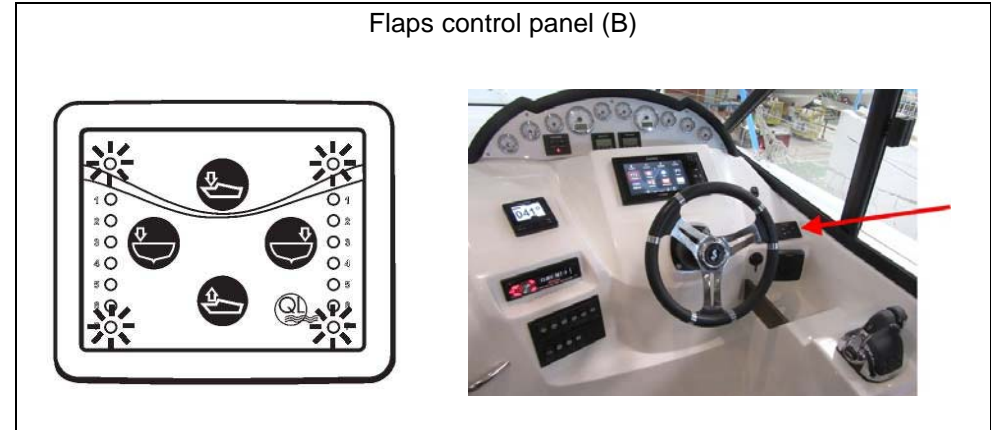

Interception unit (C)

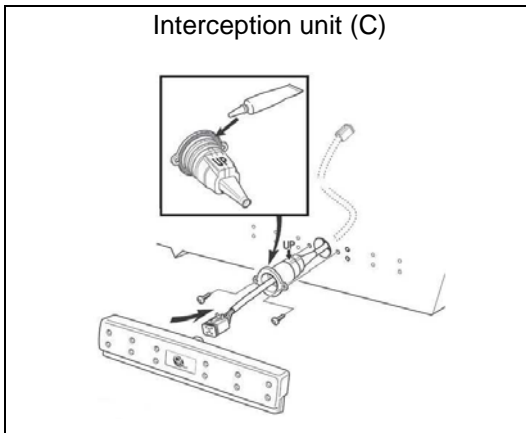

Blades (Interception units) (C)

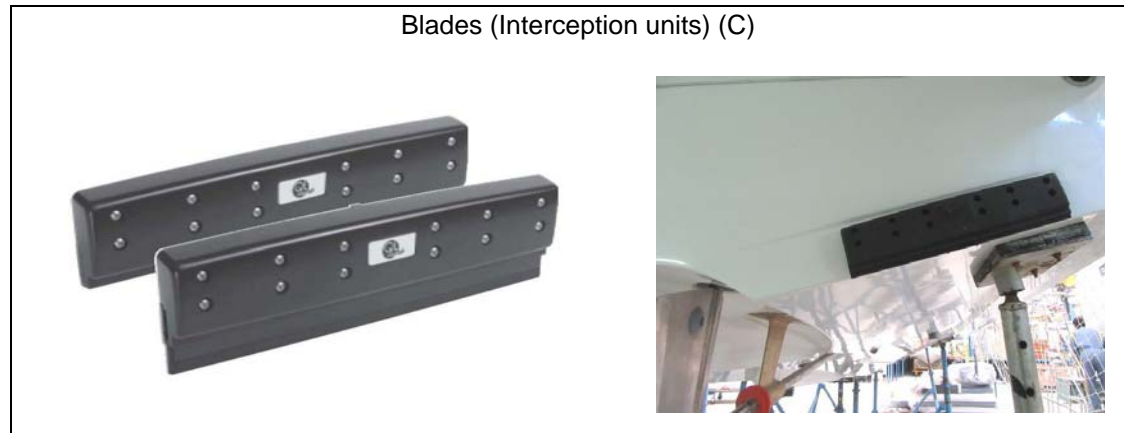

### 13.11 PROPELLER SHAFT

- The shaft is stainless steel.
- The shaft is aligned in the factory. When the boat is launched, its re-adjustment must be carried out by a professional.
- A hydrolube bush holds the shaft in the bracket.

This is a wearing ring. Check the hydrolube bush every time the boat is slipped. Change the hydrolube bush if necessary.

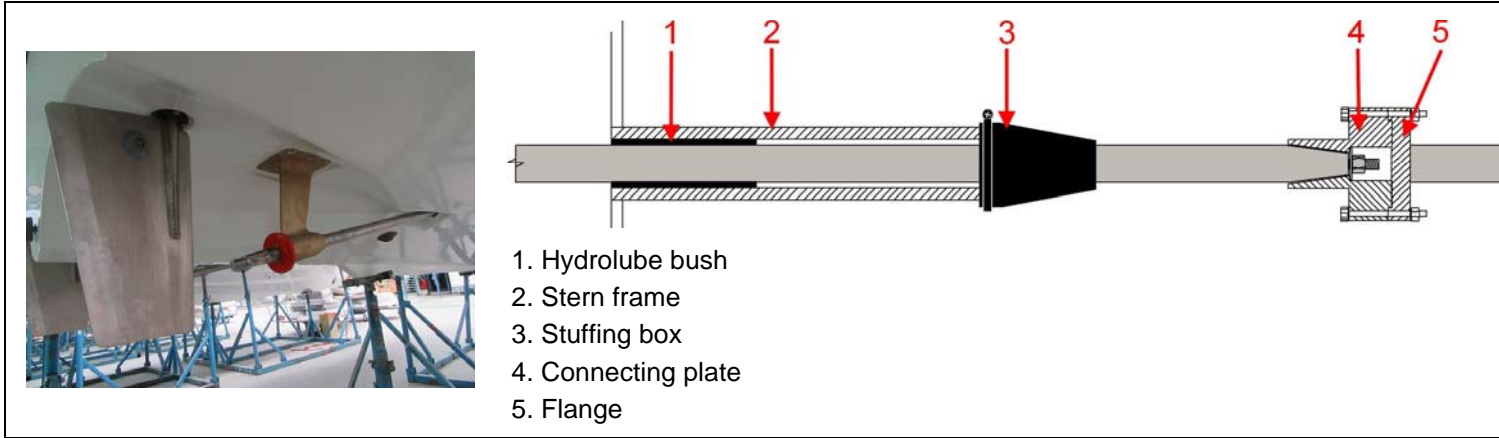

### 13.12 STUFFING BOX

- The stern gland keeps the propeller shaft watertight.
- The stern gland is accessible through the engine compartment.
- Grease the watertight joint every 200 engine hours (or at least once a year). Apply grease as recommended by the mechanic.
- The stern gland is lubricated directly by the engine cooling water/by a sea water supply valve.
- After launching the boat, drive the air out from the sleeve pinching it with your fingers.

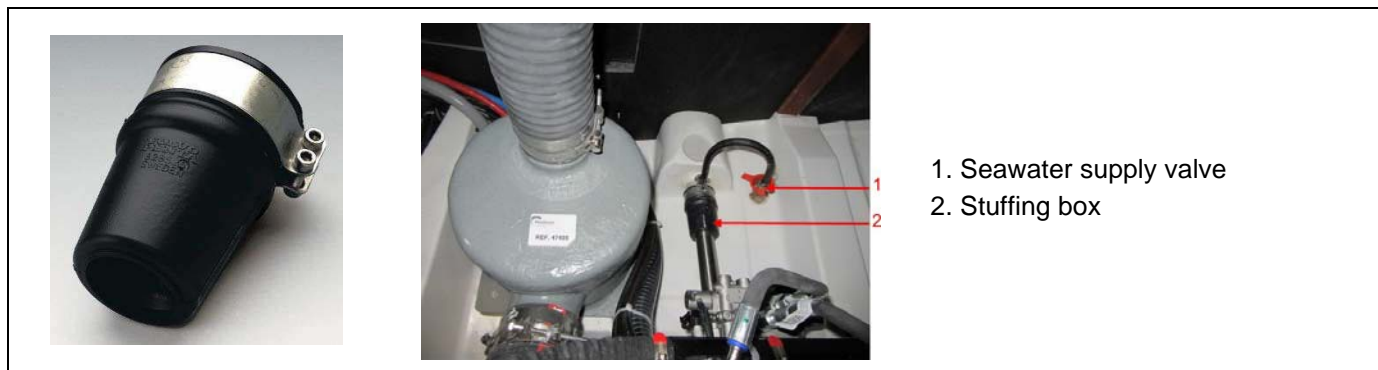

1. Seawater supply valve
2. Stuffing box

### 13.13 PROPELLER

- The propeller delivered with the boat represents the end result of trials carried out in collaboration with the engine manufacturer. Never change the propeller without first consulting a professional engineer.
- Propeller efficiency will drop if the propeller blades are damaged in any way or dirty: regularly clean the blades carefully.
- During a lift-out, check the propeller: it should turn freely on its axis and there should be no play.
- Boats with twin engines are equipped with counter-rotating propellers.



- Respect speed limits..



## STEERING SYSTEM

■ General points .....	148
■ Layout diagram.....	149
■ Hydraulic steering .....	151
■ Bow thruster .....	152

#### 14.1 GENERAL POINTS

- The steering is hydraulic.
- The steering system is an important safety feature. For this reason, the annual inspection of the whole system must be carried out by a professional engineer.

Two helm stations are fitted on the boat:

- main helm station in the saloon,
- secondary helm station on the flying bridge.

**NOTE:** *Some functions or commands are only accessible from the main helm station.*



## 14.2 LAYOUT DIAGRAM

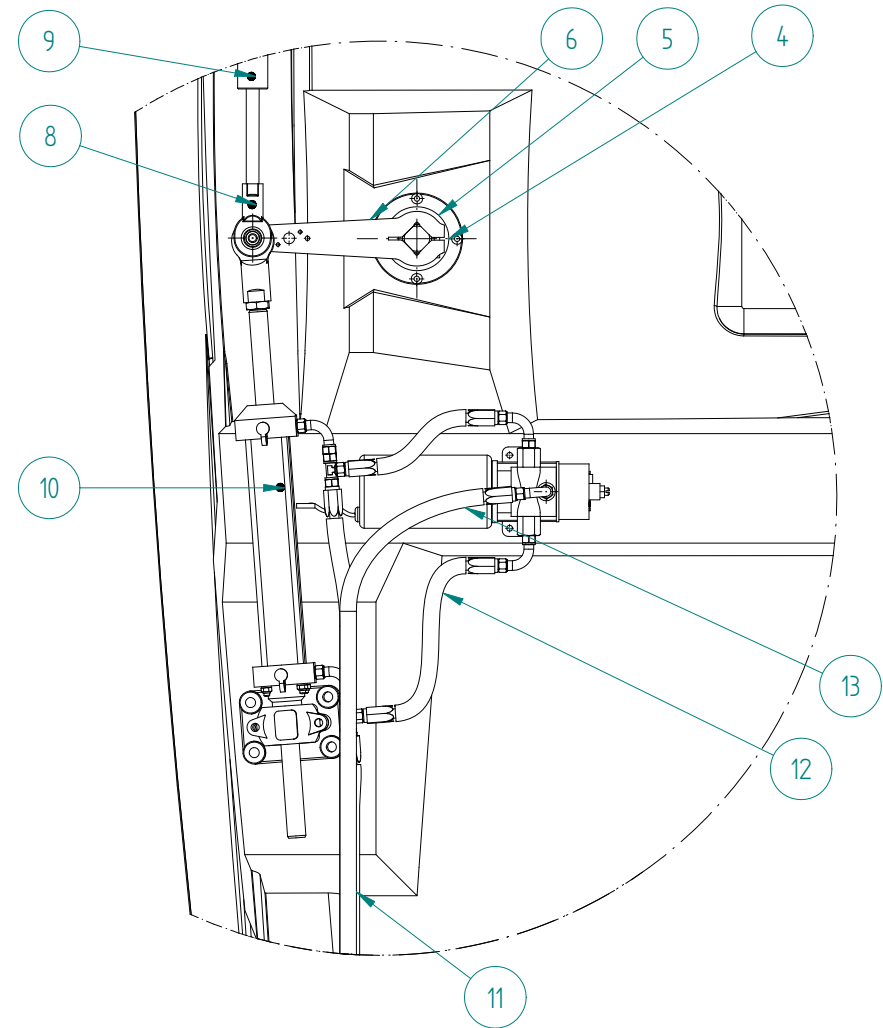
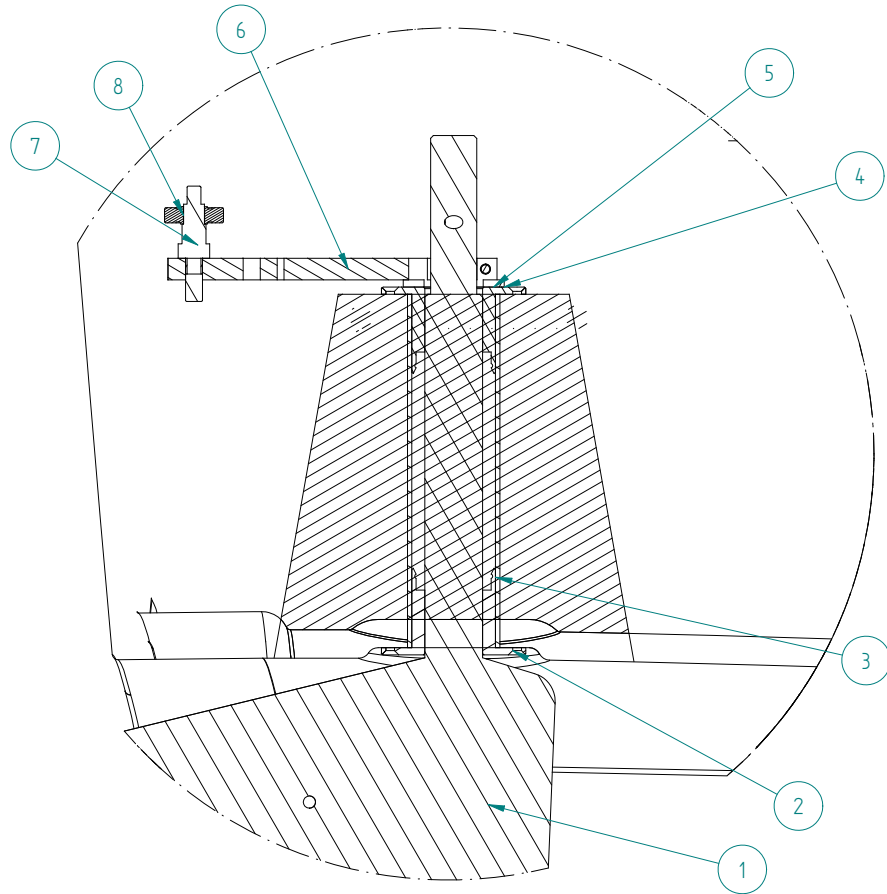

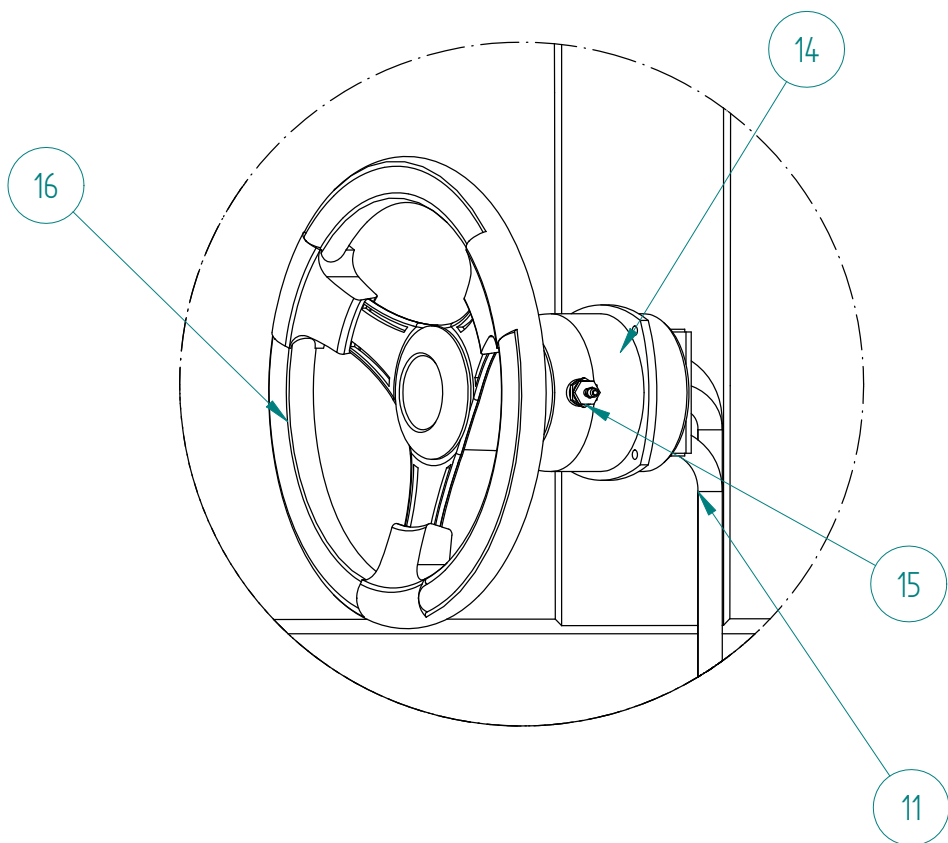

Reference	Designation	Quantity
1	Rudder stainless steel	2
2	Black flanged bush	2
3	Rudder port tube	2
4	White flanged bush	2
5	Balance bush	2
6	Steering connecting rod	2
7	Rocker bar pin	2
8	Ball yoke	2
9	Tie bar	1
10	Piston + 2 Bleeds	1
11	Hydraulic transmission kit	1
12	Hydraulic transmission kit - Auto pilot	1
13	Reversible unit - Pilot	1
14	Hydraulic pump	2
15	Bleed caps	2
16	Steering wheel	2

### 14.3 HYDRAULIC STEERING

#### General points

- The hydraulic pump allows the boat's steering to be controlled.
- It is essential that dismantling the wheel should be carried out with the aid of a 'hub puller' type tool. Never tap or lever the wheel to access the pump.

#### Replenishing and bleeding the circuit

- This task must be carried out by a professional engineer: please consult your dealer.
- Use only oil ISO 22.
- The whole of the hydraulic circuit must be kept scrupulously clean: any impurity risks causing the deterioration of the steering gear.

#### After each winter, check

that rotating the wheel to starboard turns the boat to starboard;

that the circuit is properly bled;

that there are no leaks in the connections, the pumps, the ram or the flexible hydraulic hoses;

that the pump is filled with oil to the correct level(25 mm of air must be left in the pump : this space is vital for the hydraulic circuit to work properly, it allows the oil to expand);

that the nuts and screws are fully tightened to the correct torque as shown in the manufacturer's instructions;

that the hydraulic hoses have not been flattened or deformed.



Refer to the manufacturer's instructions for use and maintenance.

## 14.4 BOW THRUSTER

### General points

- The bow-thruster's motor is DC powered.
- The bow-thruster assists with steering the boat when manoeuvring at low speed (picking up a mooring buoy or berthing on a pontoon for instance).
- An operating relay is installed in the circuit.
- A fuse protects the electrical circuit.
- The bow-thruster motor has its own battery bank.

### Operation

- Turn on the bow thruster battery switches.
- The engine's positive battery isolator automatically comes on and goes off when the engine is started/stopped. The thruster circuit negative is connected to the boat's general negative.
- The bow-thruster motor must operate with the boat's engine running.
- A control panel is located in the wheelhouse/on the flybridge.
- To turn the bowthruster on or off, press the red button while holding the joystick pushed to the right for a few seconds.
- When the bow-thruster motor is not in use, switch off the electrical supply both:
  - to the control panel,
  - and to the switches of the motor's batteries.

### Maintenance

- The bow-thruster's motor:
  - is lubricated for life and the oil does not require draining;
  - must not be dismantled, even partially.
- Regularly check the charge state of the motor's batteries: a loss of voltage will cause premature wearing of the motor's relay contacts and brushes.

### During lift-out

- Check that the propellers turn properly, with neither play nor stiffness.
- Clean the blades carefully.
- Remove the propeller, clean the shaft support, smear the shaft with silicone-based grease before refitting the propeller.
- After cleaning and applying a primer, antifoul the housing and the propellers.

Access to elements: under the bed in the forward cabin



1. Positive battery isolator switch
2. Fuse (275A)
3. Battery (50A)
4. Bow thruster



Control



Nozzle + Anode



- Refer to the manufacturer's instructions for use and maintenance.
- Never run the motor when the propeller is out of the water.
- In the case of dual control, be careful to use just one control at a time.
- The motor must not run for longer than 3 minutes (risk of overheating).



## DECK FITTINGS

■ General points .....	156
■ Equipment .....	158
■ Berthing, anchoring, towing.....	160
■ Main elements of the chain locker .....	162
■ Electric windlass .....	163

## 15.1 GENERAL POINTS

Alcohol, solvent or acetone based solutions to clean / maintain the outer surfaces of the boat are not to be used. A warm soapy water based solution is preferred.

### 15.1.1 GRP

- Regularly brush the deck using a gentle de-greasing agent then rinse the deck with fresh water.
- Use as few cleaning agents as possible.
- Don't use solvents or aggressive detergent agents.
- Don't discharge cleaning agents into the water: Consult the harbourmaster's office to find out the conditions of water use and the maintenance area for cleaning your vessel.
- Don't use a pressure washer.

### 15.1.2 Plexiglas (PMMA)

- Rinse plexiglas with fresh water.
- Use a polish paste for thin scratches.
- Consult your dealer concerning deep scratches.

### 15.1.3 Stainless steel

Stainless steel is an alloy of iron and carbon (steel) with the addition of chromium. This chromium provokes the formation of a protective film which separates the steel from the atmosphere outside. This coating is usually invisible as it's so thin. So in spite of its name this steel is not stainless and requires a minimum of maintenance:

- The use of chrome tools is preferable whenever handling stainless steel;
- Re-nourish the protective film regularly with passivation paste.



Never use solvents, alcohol, acetone or detergents on the plexiglass.



#### 15.1.4 Solid wood on exterior wooden panelling

- Wood exposed to harsh conditions, such as salty air and UV rays tends to become whiter and to lose its natural colour. This phenomenon has no effect on the intrinsic qualities of the wood, but can spoil its aesthetic appeal.
- To maintain the colour of the wood, regularly wash the woodwork in fresh water using a sponge (if necessary, use a mild soap).
- It is recommended to oil the external woodwork regularly using teak oil to protect them from the harsh conditions.

#### 15.1.5 Exterior upholstery

- Bring the removable cushions inside (washed with soapy water then dried) when the vessel is unoccupied.
- Put canvas sheets/protective covering over the fixed upholstery.

##### Maintenance

To maintain the quality of the fabric, you are advised to spray it regularly with clarified water and to brush it with a soft brush (brush for clothes). It is advisable to clean thoroughly every 2 years.

##### Stain removal

Follow these steps for routine cleaning:

- Remove as much debris as possible using a soft brush;
- Spray the fabric with water;
- Prepare a cleaning solution using mild soap and water (Do not use detergent);
- Wash with a soft brush;
- Wait for soapy solution to act;
- Rinse thoroughly in fresh water;
- Dry in the open air.



Never use detergents, acetone or other harsh products on the wood.



Beyond 20 knots of Wind, you are advised to stow all removable protection sheets (Bimini, Covers...).



Never:

- Use a heat source (hairdryer/clothes dryer);
- Use detergent, silicone, acetone, chlorine-based products or hot water;
- Use a high pressure cleaner.

## 15.2 EQUIPMENT

### 15.2.1 Gangway

#### Description

- The gangway allows you to embark/disembark easily when the boat is moored stern on to the pontoon.
- The gangway is hydraulic; telescopic (adjustable length); fixed.
- The gangway control is situated in the cockpit.
- The gangway is comprised of the external part and a hydraulic unit situated in the engine compartment.
- A control box situated on the hydraulic unit prevents accidental operation of the control panel. As a precaution it is advised to leave it on the "AUTO" setting.
- The hydraulic pump controlled by the electric motor is situated under the hydraulic unit reservoir. The motor has a speed regulator: it controls the speed at which the gangway moves.
- The gangway can also serve as a davit for lifting out the tender.

#### Operation

- The gangway runs on DC power.
- A breaker protects the electrical circuit.
- The gangway motor is designed to run continuously for a maximum of 4 minutes. After this the motor will cut out automatically (risk of overheating).

#### Maintenance

- Wash the gangway off regularly with clean water.
- Its location at the stern of the boat makes the gangway particularly prone to fouling due to the exhaust gases: clean the fouled areas regularly with a non-abrasive detergent.
- Check the oil level in the hydraulic unit once a year.
- Regularly check the connections which could loosen with vibration.



- Do not use the gangway when at sea.
- Never manoeuvre the gangway with anyone on it, below it or within its arc of movement.
- Do not use the gangway as a diving board.



- Refer to the manufacturer's instructions for use and maintenance.
- Maximum load permitted on gangway: 110 kg.
- Telescopic gangway: Ensure that the stanchions are correctly seated in their sockets before recovering the gangway.
- Manual operation prevents the position sensors from working: the electronics are no longer able to correct the alignment of the gangway if it is not retracting correctly into its housing. Use this procedure with caution.

Hydraulic unit

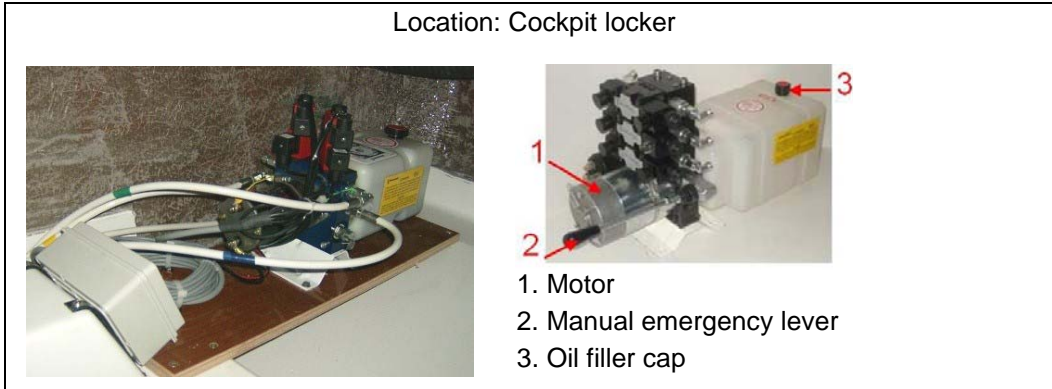

Emergency procedure

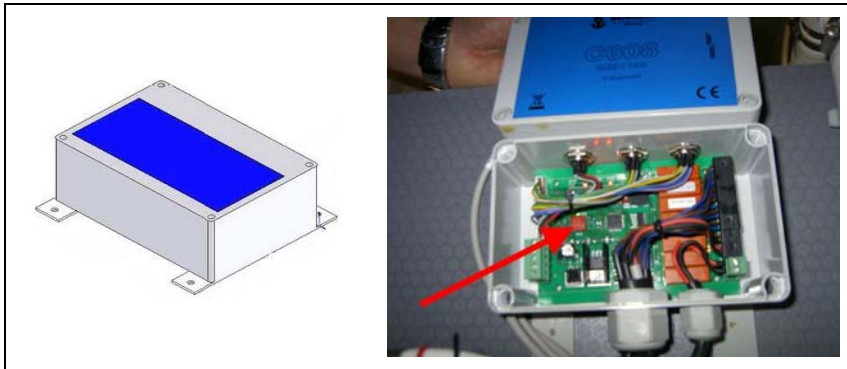

- A key allows the user to open the electronics box to put the emergency switch to ON.
- Operate the manual lever to stow the gangway.
- Put the switch back into its original position after the manoeuvre.

Control

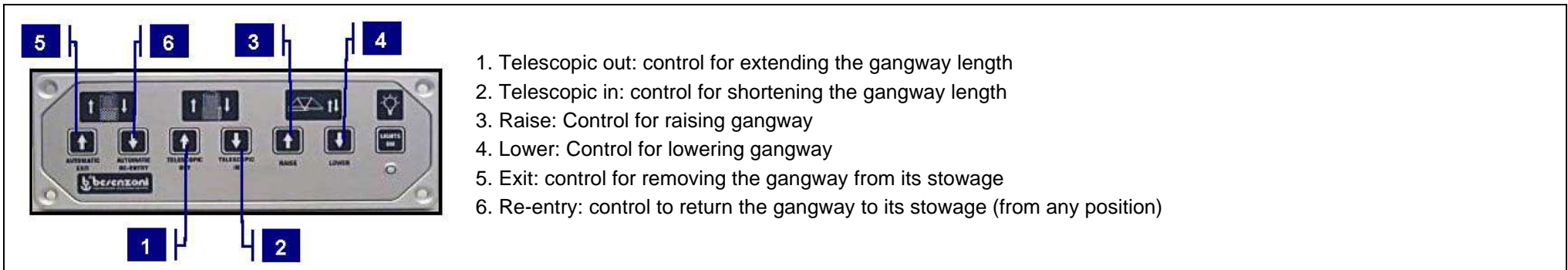

## 15.3 BERTHING, ANCHORING, TOWING

### 15.3.1 Anchor points

#### Responsibility

It is the responsibility of the owner/user of the boat to ensure that the berthing lines, towing cables, chains and mooring lines and the anchors are adequate for the intended use of the boat, i.e. that the lines or chains do not exceed 80 % of the breaking strength of the corresponding anchor point.

If the boat is towed, it is essential that the PODs are in line with the boat (see Chapter "Instructions in the event of steering gear failure").

	MOORING LINES	MOORING	TOWING
Reference (Diagram on next page)	A	A / B	A / B
Anchor Point Breaking Strength	24,2 kN	34,7 kN	34,7 kN
Mooring Line/Chain Breaking Strength	19,3 kN	27,8 kN	27,8 kN

Pass warps through the fairleads provided for this purpose.



 The anchoring points or those showing visible signs of deterioration must be replaced.

### 15.3.2 Towing

Responsibility: It is important that the owner thinks through the actions required when securing a towing cable onboard.

#### Location of attachment points



- Generally the breaking strength of lines/ chains must not exceed 80% of the breaking strength of the anchor points.
- Always tow or be towed at low speed. Never exceed the maximum speed of a displacement hull during a tow.
- Be particularly vigilant when the end of a towing cable is being thrown or received (risk of the end becoming caught in the propeller).
- A towing cable must always be secured in such a way that it can be released under load.
- Do not try to stop the boat by using a boathook or your foot, hand or any other part of your body.

## 15.4 MAIN ELEMENTS OF THE CHAIN LOCKER



- ! - Refer to the manufacturer's instructions for use and maintenance.
- Windlass operations are dangerous:
  - Always keep the anchor chain or rode free and unfouled;
  - Carry out manoeuvres carefully and always wear shoes;
  - Avoid wearing baggy clothing, long hair that's loose and jewellery that could get caught in the engine when it is running.

## 15.5 ELECTRIC WINDLASS

### General points

- The windlass is DC powered.
- The windlass is designed for anchoring purposes: Any other use is dangerous and forbidden.
- An operation relay is fitted to the electrical circuit.
- A circuit-breaker protects the power supply to the windlass.
- The windlass operation is activated by an operational interlock relay which is powered by the engine's alternator: the windlass only works when the boat's engine is running.
- The controls to raise/lower the windlass are protected by a circuit-breaker positioned between the batteries and the windlass relay.
- Your boat may be equipped with a chain meter: this shows the length of chain let out.

### Operation

- Before lowering the anchor, make sure that the chain or anchor rode is securely attached to the clinch.
- Activate the circuit-breaker then use the control to start the windlass.

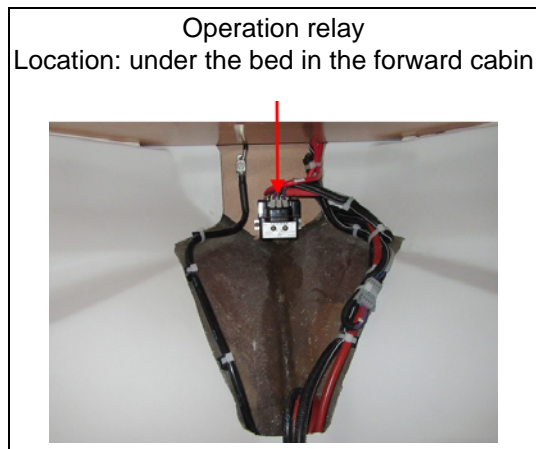
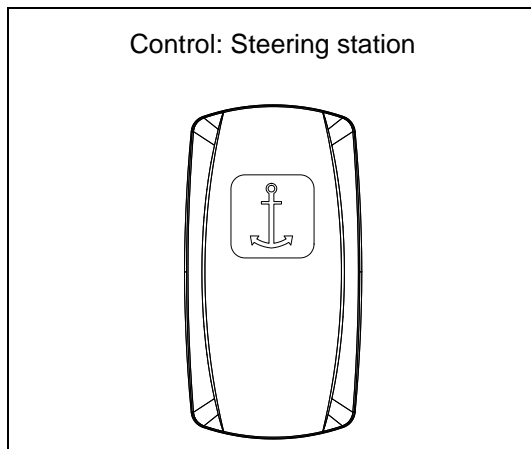

- **When at sea, secure the chain or anchor rode to secure points such as the chain stopper or the anchor rode to the belaying cleat (the windlass must not be used as the only method of securing the chain or rode).**
- In the case of dual control, be careful to use just one control at a time.
- When raising the anchor, use the boat's engine to move towards the position of the anchor, until the boat is just over it: never use the windlass as a winch to move the boat forward.
- When out at sea, cut the electrical supply to the windlass.
- Cut the electrical supply when using the windlass manually.

## Maintenance

- once a year, dismantle, carefully wash and grease all the moving parts of the windlass.
- Regularly grease the supply terminals of the electric motor of the windlass and of the relay control box.

## Emergency anchoring procedure

In the event of an electrical fault, it is possible to lower the anchor manually: Put the handle in the space provided for this to release the chain grab. Then let the chain run out using the handle to control its speed as it runs.



The handle serves only to release the chain grab in order to lower the anchor manually should the electric windlass break down.

The handle cannot be used to raise the anchor manually.



- Before anchoring check the depth of water, the power of the current and the nature of the sea bed.

- Check the swinging area once the boat is at anchor.

- After each trip rinse the windlass and anchor chain or rode with fresh water.



### LAYOUT DIAGRAM - CHAIN METER

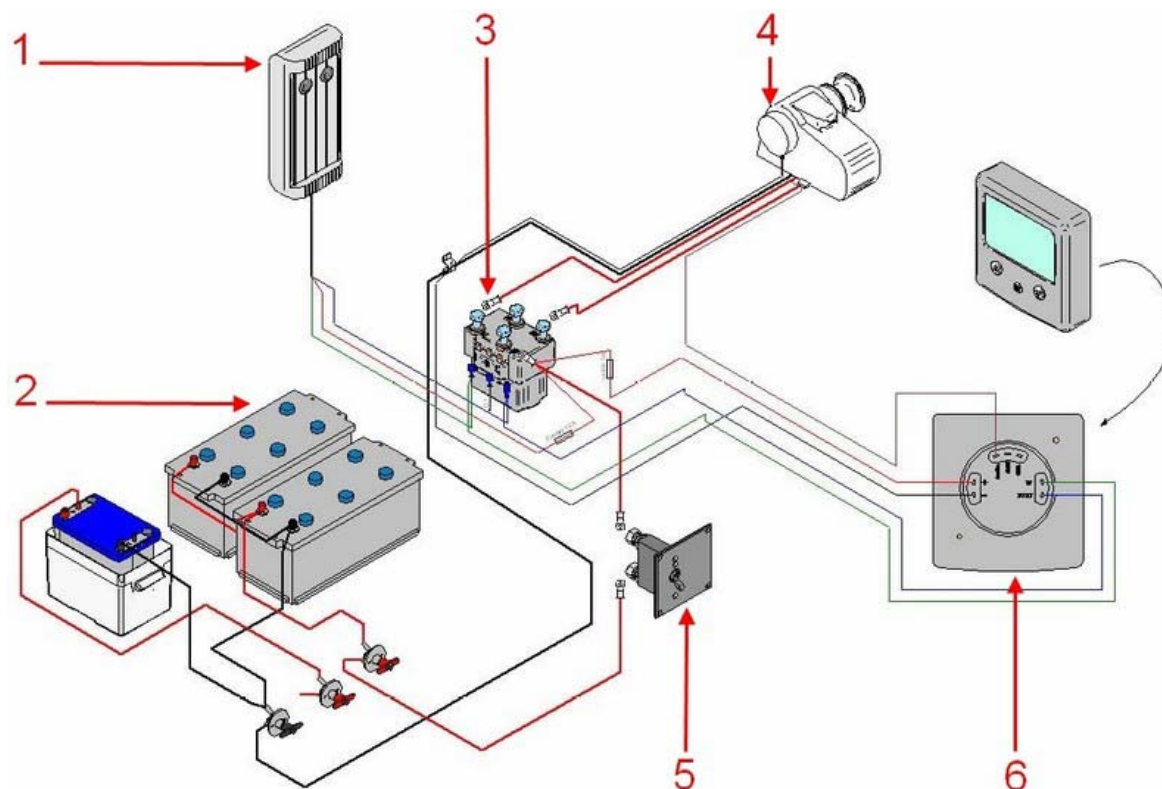

Reference	Designation
1	Remote control for the windlass
2	Service batteries
3	Operation relay
4	Windlass
5	Breaker
6	Chain meter



## HULL FITTINGS

■ Upholstery.....	168
■ Interior woodwork .....	171
■ Interior maintenance .....	171

## 16.1 UPHOLSTERY

### LEATHER

#### Maintenance

Leather must be regularly cleaned and waxed.

To do so, clean the leather surface with a damp rag. This operation will remove dust.

Every 6 months to a year depending on use, apply a leather shampoo on the leather then use a hydrating cream which will also protect it.

#### Stain removal

If the leather surface gets stained, clean immediately using an absorbent piece of paper. Do not scour. Clean inwards to prevent the stain from spreading.

- Buffer applying denatured alcohol with a piece of cotton (ink and food stains).
- Apply absorbent powder (talcum) on grease stains.

Wait a couple of hours, then brush the excess of powder.

- Other: Apply white vinegar or acetic acid diluted in water.



- Test the product on a small hidden area of the surface before cleaning.
- Avoid excessive moisture.
- Do not scrub on leather surfaces.
- If you notice leather colour on the rag, immediately stop cleaning.

## **ALCANTARA (microfibre)**

### Stain removal

The fabric must be free from dust before removing. To do so, use a vacuum cleaner to achieve optimal cleanness.

Rub with a duster soaked in a solution containing ammonia diluted by 10%. Dilute to the strength appropriate for this fabric. Try it out first on a hidden corner, the hem for instance, if the appearance of the fabric changes, dilute accordingly.

Scrub the Alcantara fabric in all directions, particularly on the stains.

Rinse off the cleaning solution using a damp cloth.

Dry in the open air.

After taking the Alcantara fabric off, it's a good idea to use a soft brush on it to bring back its supersoft quality.

For difficult stains, dry-cleaning is recommended.

## **SYNTHETIC FABRIC**

### Stain removal

If you can remove the fabric:

- Clean in the washing machine (use the program for delicate fabric) at 30°.
- Do not iron.
- Never use Javel water.
- Do not dry-clean.
- Do not use a clothes drier.

If you cannot remove the fabric:

- Clean with the vacuum cleaner,
- Clean with a foam for synthetic fabrics (see foam use instructions).

## **COATED FABRIC (PVC)**

### Maintenance

- The PVC must be regularly cleaned with soapy water to maintain its appearance and avoid accumulation of debris. Try to avoid using the following products: lacqueurs, aggressive cleaning products, detergents, xylene or acetone-based products which can cause permanent damage or make the fabric deteriorate. The use of such products is at the owner's risk.

### Stain removal

- All stains must be quickly removed to avoid formation of permanent stains.
- Use mild water to remove the stains found on the fabric surface. Use only clean, white, damp pieces of cloth.
- Difficult stains can be removed using a mixture of water (25%) and white spirit.
- Rinse with clean water.
- Dry with a soft piece of cloth.

## **ACRYLIC (bimini fabric type)**

### Maintenance

To maintain the quality of the fabric, you are advised to spray it regularly with clarified water and to brush it with a soft brush (brush for clothes). It is advisable to clean thoroughly every 2 years.

### Stain removal

Follow these steps for routine cleaning:

- Remove as much debris as possible using a soft brush;
- Spray the fabric with water;
- Prepare a cleaning solution using mild soap and water (Do not use detergent);
- Wash with a soft brush;
- Wait for soapy solution to act;
- Rinse thoroughly in fresh water;
- Dry in the open air.

## 16.2 INTERIOR WOODWORK

- Clean the interior varnish using a de-greasing shampoo on a damp cloth.
- Polish the interior varnishing with a chamois leather.
- If there are any stains or light scratches, it is possible to polish the varnish. Doing this can give the polished area more of a shine than the rest of the varnishing onboard.
- If there are deeper scratches, it is possible to sand the scratched area lightly and then re-varnish it (consult your dealer).

## 16.3 INTERIOR MAINTENANCE

- Take advantage of fine weather to air the interior upholstery.
- Remove the cushions during lengthy periods of absence.
- Make sure the bilges are clean and dry.
- For lengthy periods of absence, leave the icebox and fridge doors open to prevent mould from developing.
- Use a dehumidifier in the saloon and ensure cabin and storage doors are left open (cupboards, iceboxes...).

Forward door open / close



- If the stains persist or if in doubt, consult a cleaning specialist.
- When winterising the boat, make sure the curtains are pulled to prevent the fabrics from being exposed to the sun's rays for a lengthy period (risk of fading).
- NEVER:
  - Use a heat source (hairdryer/clothes dryer);
  - Use detergent, silicone, acetone, chlorine-based products or hot water;
  - Use a high pressure cleaner.





## HANDLING, TRANSPORT

■ Lifting plan .....	174
■ Lifting.....	175
■ Upper limit of antifoul .....	175
■ Launch/Lift out.....	176
■ Winter Storage .....	177
■ Transport.....	178

## 17.1 LIFTING PLAN

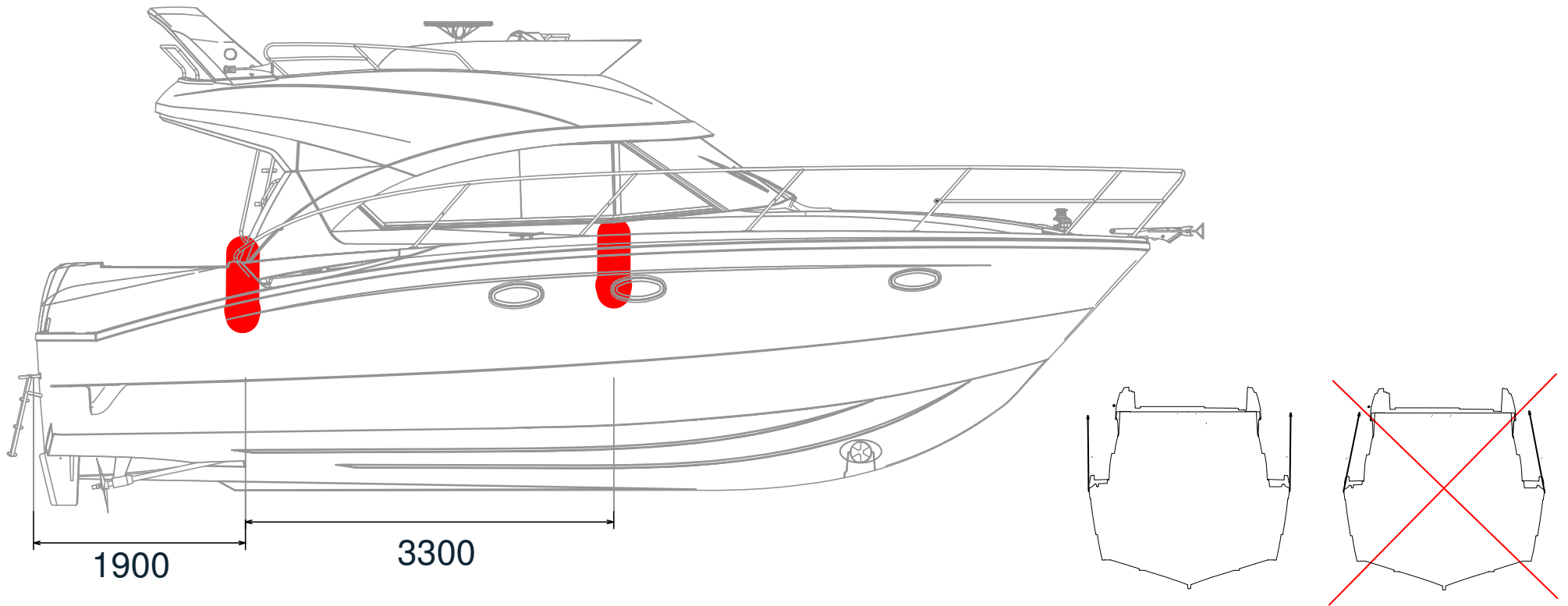

*Note: Measurements are expressed in mm.*

The position of the lifting slings is shown in the pictogram below:



## 17.2 LIFTING

- Before the first application of antifouling to the hull, you can lightly sand the hull using 400 µm or more wet and dry sandpaper.
- The lower hull of your boat should be covered with an anti-fouling paint which will prevent the adhesion of marine growth.
- The nature of the water where you keep your boat and the frequency of lifting it out determines the choice of antifouling.
- All bronze or steel surfaces, including the propellers, should be protected by a suitable antifoul paint.
- During lift-outs, check the anodes, cutlass bearing and propeller (see corresponding chapters).

Before applying the antifoul NEVER:

- Do any sandblasting;
- Use any other solvents than ethylic alcohol;
- Use detergents under pressure;
- Use scrapers;
- Use grinding tools.

If cleaning off existing antifouling requires high pressure washing:

- Ensure the water temperature does not exceed 15 degrees;
- The water pressure must not exceed 150 bars (2175 PSI);
- The distance between the hose nozzle and the hull must not be less than 10 centimetres.

The wet surface area of the boat is about: 31 m<sup>2</sup>.

## 17.3 UPPER LIMIT OF ANTIFOUL

The boat's hull has a shallow indent moulded along its length: the upper marking corresponds to the upper limit of antifoul on the hull.



- Follow the manufacturer's recommendations scrupulously when applying antifouling.
- Never cover with antifouling:
  - the anodes;
  - the earthing plates (Generator);
  - the sensors of the electronic instruments.
- Avoid using copper or tin-based antifouling: these are banned in some countries.

## 17.4 LAUNCH/LIFT OUT

The initial commissioning of your boat will require a lot of skill and care. The proper working of all your boat's equipment is the result of the quality of the commissioning operations. This is why the initial launch must be overseen by your dealer.

### Before launching

- Replace the log in its housing.
- Check the cleanliness of the sea water strainers.
- Check the anodes (see Chapter: ELECTRICAL SYSTEM).
- Check the propeller/hydrolube bush (see Chapter: STEERING SYSTEM).
- Prepare enough fenders and lines.
- Check the engine's sea water intake valve and the fuel feed valve (see Chapter: ENGINE).



Do not remain onboard or beneath the boat during the handling operations.



- When placing the slings make sure that the positioning marks are still visible.
- Submerge the sling fully under the engine mounting.

## 17.5 WINTER STORAGE

- Take advantage of laying up the boat to carry out a full inventory of the equipment.
- Check the expiry dates of the safety equipment.
- Have the liferaft overhauled.
- Empty the complete water system inside and outside and rinse it through with a mix of water and vinegar (do not use a chlorinated product).
- Empty and rinse the complete black water system.
- Dry out and clean the boat's bilges.
- Grease and close all the valves and through-hull fittings.
- Close all the boat's seacocks.
- Remove the depth sounder and log sensors.
- Put the covers back on the electronic screens.
- Use a dehumidifier in the saloon and ensure cabin and storage doors are left open.
- Air all of the cushions and upholstery for a good while before putting them back onboard and arranging them so as to limit the surface areas touching.
- Close the blackout curtains.
- Leave open the fridge/icebox doors to prevent mould and smells from developing.
- Protect the boat as well as possible with fenders.
- Make sure the boat is properly moored.
- Grease all mechanical and moving parts (bolts, hinges, locks...).
- Remove the movable upholstery.
- Disconnect the batteries. Make sure you recharge them during the winter period if the boat is left inactive for too long.



- The winterisation of the engine requires the skills of a professional engineer: please consult your dealer.

- This is not an exhaustive list of recommendations: Your dealer will give you the advice you need and will carry out the technical maintenance of your boat.

PACKING PLAN

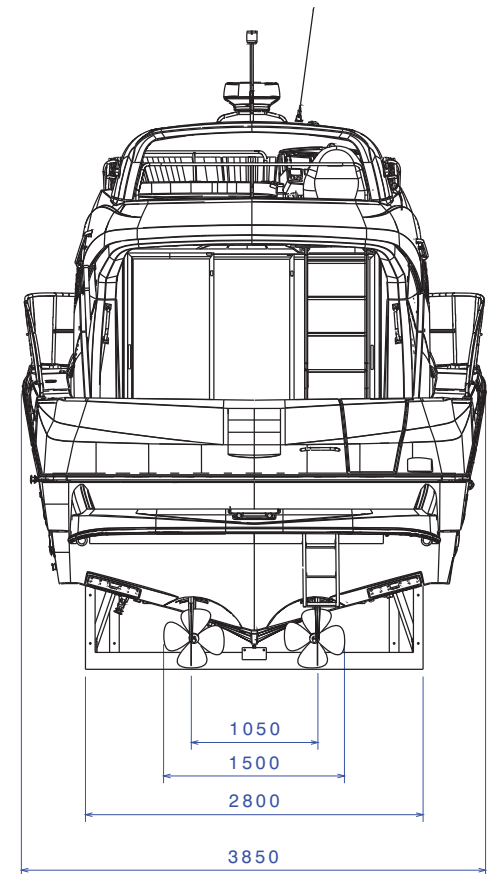
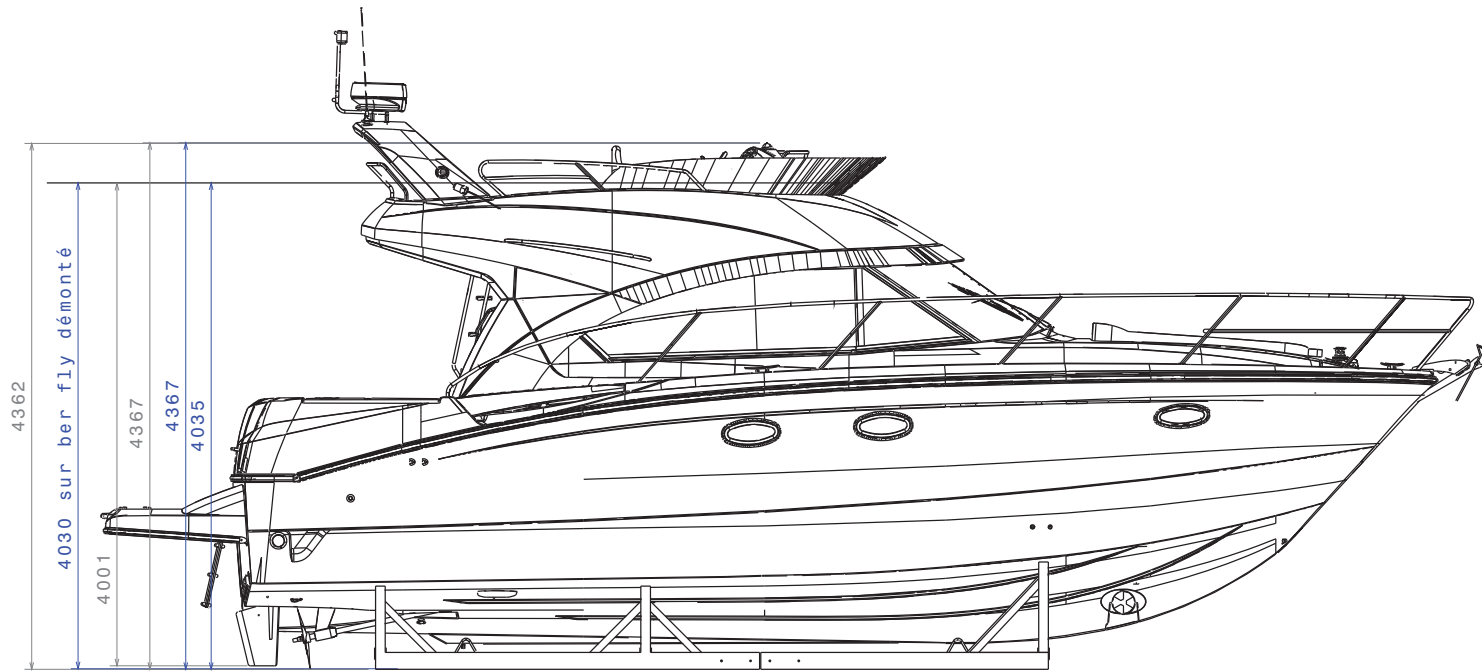

*Note: Measurements are expressed in mm.*

## ENVIRONMENT

■ Waste management.....	180
-------------------------	-----

## 18.1 WASTE MANAGEMENT

- Throw all packaging in the recycling containers provided for this.
- Once a piece of equipment has completely stopped working, find out about the relevant recycling regulations from your nearest recycling centre or from your dealer.
- Make sure you follow the relevant local laws when you scrap it.
- Some onboard equipment can have a toxic effect on the environment and on human health, caused by the specific substances they contain: Do not throw any equipment in household waste containers and absolutely not in the sea.
- Dead batteries are toxic to health and to the environment. So, batteries must not be put in with household waste, but must be recycled separately. Contact the harbour master or a specialist company about recycling them.









- Make sure you know the local environmental regulations and follow the codes of best practice.
  - Do not pump out the toilets or the contents of the black water tank near the coast or in areas where it's forbidden. Use the pump-out facilities available in ports or marinas to empty the contents of the black water tank before leaving port.
  - Make sure you know the international regulations to prevent pollution in the marine environment (Convention MARPOL) and follow these as much as possible.

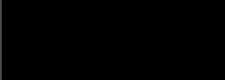

## APPENDIXE

■ Meaning of the labels .....	182
-------------------------------	-----

## MEANING OF THE LABELS

					
Engine group	Plumbing group	Colour - WC group	General electrical equipment	Comfort group	Drainage group



Valve location label

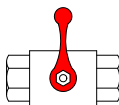



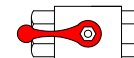





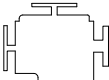











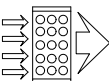











Closed valve

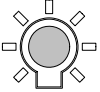

Open valve

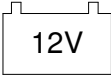
## Meaning of the symbols

	Motor		Shower		Electric pump
	Port engine		Washbasin		Manual pump
	Starboard engine		Icemaker		WC Toilet
	Propeller shaft		Deck wash		Washer
	Filter		Sea water tap		Dryer
	Hull drainage		Waste water tank		Dishwasher
	Sea water intake		Fresh water tank		Water maker

	Shore power socket		Fuel tank		Fuel filter
	Service		Holding tank		Inverter
	Generator		Battery stock		Heating
	Breaker		Thruster		Air conditioning

Each label is defined by:

- a functional group (specific colour);
- a component.

